



— GUIDE FOR —
**RESILIENT THERMAL
ENERGY SYSTEMS DESIGN
IN COLD AND ARCTIC CLIMATES**

THIS PAGE INTENTIONALLY LEFT BLANK

Guide for Resilient Thermal Energy Systems Design in Cold and Arctic Climates

Editor: Dr. Alexander Zhivov, U.S. Army Engineer R&D Center, Champaign, IL

Contributors:

Thomas A. Adams - Air Force Civil Engineer Center, Tyndall AFB, FL (Ch.6), Lyle Axelarris, PE - Design Alaska, Fairbanks, AK (Ch. 4), Kevin Bjella, P.E. - U.S. Army Engineer R&D Center, Fort Wainwright, AK (Ch. 1, Ch. 5), Dayne Broderson - University of Alaska, Fairbanks, AK (App. B), Aaron Cooke - Cold Climate Housing Research Center, Fairbanks, AK (Ch. 4), Brandy Diggs-McGee - U.S. Army Engineer R&D Center, Champaign, IL (Ch.8, App. B), Thomas A. Douglas, Ph.D. - U.S. Army Engineer R&D Center, Fort Wainwright, AK (Ch. 1, Ch. 5), Anders Dyrelund - Ramboll, Copenhagen, Denmark (Ch. 6 and Ch. 7), Craig Fredeen, PE - Cold Climate Engineering, LLC, (Ch.1, Ch.6), Robbin Garber-Slaght, PE - Cold Climate Housing Research Center, Fairbanks, AK (Ch.1), Brent Goering - USACE, Alaska District, Fairbanks, AK (Ch. 6), Oddgeir Gudmundsson – Danfoss, Nordborg, Denmark (Ch.6 and Ch. 7), Bill Kirkenir - GVEA consultants, Fairbanks AK (Ch. 7), Emmett Leffel - Alaska Thermal Imaging LLC (Ch.4, App A), Richard J. Liesen, Ph.D. - U.S. Army Engineer R&D Center (Ch.4, Ch.8 and App. B), Brianna Morton - U.S. Army Engineer R&D Center, Champaign, IL (Ch.8, App. B), Bjorn Oberg - U.S. Army Engineer R&D Center, Champaign, IL (Ch. 8, App. B), Raymond E. Patenaude, PE - Holmezs Engineering Group LLC, St. Petersburg, FL (Ch.2), Matt Perry – University of Alaska, Fairbanks, AK (App. B), Robin J. Rader, P.E. - Design Alaska, Fairbanks, AK (Ch.6), Lorne Ricketts, MAsc, P.Eng. RDH Building Science Inc. Vancouver, British Columbia (Ch. 4), William B. Rose - William B. Rose & Associates, Inc., Champaign, IL (Ch.2, Ch.4), Angela Urban - U.S. Army Engineer R&D Center, Champaign, IL (Ch.8, App. B), Dragos Vas - U.S. Army Engineer R&D Center, Fairbanks, AK (App. B), W. Jon Williams, Ph.D. - National Personal Protective Technology Laboratory NIOSH/CDC, Pittsburgh, PA (Ch.2), Emily C. Winfield, P.E. - Design Alaska, Fairbanks, AK (Ch.6), John P. Zarling, Ph.D., P.E. - University of Alaska, Zarling Aero and Engineering, Fairbanks, AK (Ch.1), and Alexander M. Zhivov, Ph.D., M.B.A. - U.S. Army Engineer R&D Center, Champaign, IL (Foreword, Ch.2, Ch.3, Ch.4, Ch.6, Ch.7, and Ch. 8).

January 2021

ISBN 978-1-947192-83-6 (paperback)
ISBN 978-1-947192-84-3 (PDF)

Print edition published by ASHRAE
180 Technology Parkway
Peachtree Corners, GA 30092
www.ashrae.org

ASHRAE is a registered trademark in the U.S. Patent and Trademark Office, owned by the American Society of Heating, Refrigerating and Air-Conditioning Engineers, Inc.

Table of Contents

Foreword.....	ix
Acknowledgements.....	xi
CHAPTER 1. INTRODUCTION.....	1
1.1 Traditional parameters of cold climate construction	1
1.2 Alaska –A case study	1
1.3 Weather considerations	2
1.4 Remote locations challenges	3
1.5 Seismic considerations	4
1.6 Permafrost considerations	5
1.7 Conclusions	7
CHAPTER 2. REQUIREMENTS FOR BUILDING THERMAL CONDITIONS UNDER NORMAL AND EMERGENCY OPERATIONS IN COLD AND ARCTIC CLIMATES.....	8
2.1 Introduction	8
2.2 Normal (blue sky) operating conditions	8
2.3 Emergency (black sky) operating conditions	12
2.4 Thermal requirements for unoccupied spaces	17
2.5 Recommendations.	18
CHAPTER 3. PARAMETERS FOR THERMAL ENERGY SYSTEM RESILIENCE.....	21
3.1 Introduction	21
3.2 Energy system resilience metrics	21
3.3 Maximum allowable downtime	26
CHAPTER 4. BUILDING ENVELOPE.....	28
4.1 Thermal insulation	28
4.2 Thermal bridging metrics and mitigation	31
4.3 Vapor diffusion	32
4.4 Airtightness	34
4.5 Wall and roof assemblies	37
4.5.1 Roofs	37
4.5.2 Walls	38
4.5.3 Fenestration	39
4.6 Pertinent details	40
4.6.1 Structural support of exterior finishes	41
4.6.2 Window openings	42
4.6.3 Penetrations	43
4.6.4 Wall-to-roof transitions	43
4.7 Recommendations	45
CHAPTER 5. CONSIDERATIONS FOR FOUNDATION CONSTRUCTION ON PERMAFROST.....	48
5.1 What is permafrost?	48
5.2 Construction on permafrost	50
5.3 Foundation options on permafrost	51
CHAPTER 6. BEST PRACTICES FOR HVAC, PLUMBING AND HEAT SUPPLY.....	56
6.1 Introduction	56

6.2 Heating systems	56
6.2.1 Specifics of heating systems in Artic climates	56
6.2.2 Working fluid	57
6.2.3 Perimeter heat using finned tube radiators	58
6.2.4 Radiant slab heating	59
6.3 Centralized and decentralized heat supply systems	60
6.4 Cooling	62
6.5 Specifics of ventilation systems in arctic climate	63
6.5.1 Heat recovery	63
6.5.2 Humidification system design	65
6.6 Plumbing system design	67
6.7 Remote site considerations	68
6.8 Best practices for HVAC design in arctic climate remote sites	69
6.9 Operation and maintenance and resilience	70
6.10 Conclusions.	71
CHAPTER 7. DISTRICT HEATING SYSTEMS.....	73
7.1 System design and operation	73
7.2 Thermal supply flexibility	73
7.3 Resilience enhancing operation	74
7.4 Continuous system surveillance	74
7.5 Thermal generation and supply	74
7.6 Emergency generation	75
7.6.1 Mobile boilers	75
7.6.2 Emergency electrical heating element	76
7.7 Combined heat and power	77
7.7.1 Combined heat and power (CHP) resilient design	78
7.7.2 Prioritizing CHP applications	79
7.8 Distribution network	79
7.8.1 Meshed network layout and pump strategy	79
7.8.2 Strategic location of shutoff valves	80
7.9 Utilization of fault detection equipment and preventive maintenance	81
7.10 District energy interface units	82
7.11 Case studies	83
7.11.1 Sønderborg, Denmark	83
7.11.2 Quaanaaq in Greenland	85
7.12 Conclusions	86
CHAPTER 8. EVALUATION MAXIMUM TIME TO REPAIR	88
REFERENCES.....	93
ACRONYMS AND ABBREVIATIONS	97

Appendices

Appendix A . Building Enclosure Testing on Alaska Military Base Projects.....	99
Appendix B . Thermal Energy System Resilience: Thermal Decay Test (TDT) in Cold/Arctic Climates	118

Figures and Tables

Figures

1-1	Alaska climate zones	1
1-2	Fault lines in Alaska	4
1-3	Permafrost distribution in Alaska	5
1-4	The seasonally thawed “active layer” (dark brown surface soil) and underlying permafrost along a coastal bluff near Utqiagvik, Alaska	6
3-1	System Response to a disruptive event	23
3-2	Two systems with different absorption	24
3-3	Two systems with different recovery time	24
3-4	Stepped recovery of power system assets	25
3-5	Notional example of temperature decay rate for different types of building envelope: comfortable level (t_c), habitability (t_h) and sustainability (t_s) temperature thresholds	27
4-1	Infrared thermographic image of typical thermal bridge in cold climates	31
4-2	Percent annual energy savings in a barracks building due to air tightness improvement for U.S. climate zones. Source: Zhivov et al. (2014)	36
4-3	IR Images of air leakage at roof-to-rake wall joints; ALT results = 0.25 cfm/sq ft at 75 Pa (3.5 m ³ /h/m ² at 50 Pa). Source: Leffel (2021)	36
4-4	Conventional roof assembly on a concrete structure (left) and on a wood structure (right). From exterior (top) to interior (bottom) these assemblies includes roof membrane, cover board, insulation, tapered insulation, air and vapor control membrane, and structure	37
4-5	Exterior-insulated steel stud wall assembly, and similar approaches are appropriate for other backup wall structures including wood and CMU. From exterior (left) to interior (right), this assembly consists of cladding, continuous girts exterior of the insulation to receive cladding fasteners, thermally efficient intermittent cladding attachment clips fastened to structure, air/water/vapor control membrane on the sheathing, exterior grade gypsum sheathing, structure (steel studs), and interior finish	39
4-6	Split-insulated wood stud wall assembly. From exterior (left) to interior (right), this assembly consists of cladding, wood furring attached with long fasteners, exterior insulation, air/water control membrane on the sheathing, wood sheathing, wood studs with insulation, interior vapor barrier membrane, and interior finish	39
4-7	Illustration of high-thermal performance window frame types	40
4-8	Schematic floor line details for exterior-insulated wall assemblies	41
4-9	Schematic windowsill detail showing key design elements for high-performance detailing. In particular, this detail includes a membrane upturn on a back-dam angle for enhanced water penetration resistance, continuity of the air barrier from the wall	

Figures

	system to the window product, over-insulation of the window frame to reduce thermal bridging, and sub-sill drainage to direct any water that penetrates to the sub-sill area out to the exterior of the wall assembly	42
4-10	Schematic roof-to-wall details showing key design elements for high-performance detailing. In particular, note the continuity of control layers including the air barrier systems and the insulation in each of the details	44
4-11	Indoor air temperature decay in a high-efficiency building vs. a lower efficiency building when heat supply is interrupted at outside air temperature -40°F (-40°C): (a) thermally massive building, (b) framed building	47
5-1	Images from inside the ERDC-CRREL Permafrost Tunnel in Fox, Alaska identifying some of the common ice features present in permafrost. The small ice core holes in the image on the right are 8 cm in diameter. Photos by T. Douglas, CRREL	49
5-2	Left: A photo of a meeting room at a site in Thule, Greenland, where differential settling has led to wall and ceiling cracking. Photo by T. Douglas, CRREL	49
5-3	A schematic diagram showing how electrical resistivity tomography can help guide infrastructure siting and design decision making. The area of low ice content permafrost or unfrozen soils (left, with low resistivity values) is suitable for slab on-grade construction. The area on the right, where there is high resistivity indicative of permafrost, is suitable for a structure on posts or piles	51
5-4	Removal of surface ice-rich permafrost and backfilling with thaw-stable materials allows for large slab on-grade construction. Photo by K. Bjella, CRREL	52
5-5	Examples of elevated structures on permafrost. Upper photo: An image of downtown Utqiagvik, Alaska where single-story and multi-story buildings, as well as all utilidors, are constructed above ground. Lower left: a large facility at Prudhoe Bay, Alaska. Lower right: a single-story structure at Thule, Greenland. Photos by Kevin Bjella, CRREL	53
5-6	A cross-section of a buried footer design used at Thule, Greenland	53
5-7	Images of thermosyphon installations. Left: on the Trans-Alaska Pipeline near Fairbanks, Alaska. Upper and lower right: along foundation edges of structures in Prudhoe Bay, Alaska. Images by T. Douglas, CRREL	54
5-8	A diagram illustrating the functions and operations of a typical passive thermosyphon with 'active' refrigeration coil addition for hybrid applications. Source: Wagner (2013)	55
6-1	Hydronic heating system: (a) system interface with district steam system (designed by Design Alaska); (b) mixing shunt; (c) finned tube radiator at a perimeter wall; (d) radiant tubing manifold during construction	59
6-2	Heat supply strategies using local backup or a meshed network structure	62
6-3	Small Light Commercial HRV	64
6-4	Electrode humidifier (www.condairgroup.com/know-how/electrode-steam-humidifier)	66
6-5	Steam-to-steam humidifier	67
7-1	Mobile boiler: (a) schematic of hot water mobile boiler, (b) schematic of steam mobile boiler (Taylor 2020)	76
7-2	Example of emergency electrical heating element	76
7-3	Iron diagram for modeling of an extraction condensing unit. The vertical axis indicates the power output and the horizontal axis the heat output	77
7-4	Matrix of DER vulnerability to weather events	78

Figures

7-5	Example of meshed network layout structures for district energy system. The dotted red lines represent the transformation from a branch to a meshed system type. The dotted black lines represent the pump control signal	80
7-6	Left: Example of ball valves in various sizes. Middle: Butterfly valve. Right: Shutoff valves installed in a pipeline. Source: Danfoss A/S	81
7-7	Leakage detection wires in a pre-insulated single and twin pipe. Source: Løgstør A/S	82
7-8	Schematics of indirect district energy interface. Source: Danfoss A/S	82
7-9	Schematics of direct building district energy interfaces with mixing loop to left and without mixing loop to right. Source: Danfoss A/S.	83
7-10	Sønderborg district heating system. The base load plant is a waste incineration CHP with a large thermal storage	84
7-11	Portable emergency boiler in the Sønderborg district heating system	84
7-12	The urban settlement in Quanaaaq, Greenland. Source: Ramboll A/S	85
7-13	Above-ground supply infrastructure. Source: Ramboll A/S	86
8-1	Studied building photo and model representation	88
8-2	Indoor air temperature decay in high efficiency, low efficiency, and post-1980 installation buildings with a heating system failure at outdoor air temperature of -40 °F (-40 °C): a – mass building, b – frame building	91
8-3	Comparison of indoor air temperature decay in low-efficiency frame building vs. high-efficiency mass building with a heating system failure at outdoor air temperature of -40 °F (-40 °C)	92
A-1	Graphs 1-3 Air Leakage Test Results, 2009-2020.	103
A-2	Failures and lessons learned; Bldgs. 21, 24, and 26, IR and plan details	106
A-3	Failures and lessons learned; Bldg. 29, IR and plan details	107
A-4	Minimum code construction, Bldg. 31 (0.4cfm/ft ² @75Pa requirement)	108
A-5	The tightest building examples; Bldg. 27, IR and plan details	109
A-6	The tightest building examples; Bldg. 10 digital and IR imagery	110
A-7	The tightest building examples; Bldg. 23 IR and plan details	111
A-8	Bldg. 2. Air Leakage at 0.328cfm/ft ² @75Pa showing several air leakage pathways	112
A-9	Bldg. 3, (0.242cfm/ft ² @75Pa) showing common air leakage pathways of IMP	113
A-10	Bldgs. 4 and 5, thermal signatures of EIFS wall @air leakage pathways	114
A-11	Architectural Only vs. Architectural Plus HVAC Test and Examples	115
B-1	Test Results from Bldg. B	121
B-2	Bldg. C, ambient temperatures throughout the building	122
B-3	Test results from FGA Bldg. D	124
B-4	Test results from FGA Bldg. E	125
B-5	Fort Wainwright Bldgs. 3002, 3013, and 4070, photo and model representations	127
B-6	Fort Greely Bldgs. 603 and 650, photos and model representations	129
B-7	Bldg. 3002 sensor and model comparison	132
B-8	Bldg. 3013 heating failure results shown for 18 hours; sensor data top and model data bottom	133

Figures

B-9	Bldg. 4070 first floor heating failure results	134
B-10	Bldg. 4070 second floor (a), and basement (b) heating failure results	135
B-11	Bldg. 603 Mezzanine and Front Entry air temperature details	137
B-12	Bldg. 650 model vs. sensor data	138
B-13	First-floor low-efficiency (a) and high efficiency (b) mass building heating failure results with TMY3, -20 °F, and -40 °F weather, from January 10 to 19	143
B-14	First-Floor low-efficiency (a) and High Efficiency (b) Frame Building Heating Failure Results with TMY3, -20 °F, and -40 °F Weather	145
B-15	Mass building comparison of high-efficiency, low-efficiency, and typical 1980 parameters for building heating failure results with -40 °F (-40.0 °C) Weather	146
B-16	Frame building (a) and mass building (b) comparison of high efficiency vs. low-efficiency and (typical 1980 in [a]) building heating failure results at -40 °F (-40.0 °C) weather	147
B-17	Building 4070 heating failure results in 40 °F weather	149

Tables

2-1	Recommended and allowable conditions for Classes A1-A2, and NEBS environments	11
2-2	Thermal environment requirements for selected spaces in medical facilities	11
2-3	DBT and RH requirements for occupied and unoccupied facilities to reduce the risk of moisture related problems	17
2-4	Recommended thermal conditions for buildings located in cold/Arctic climate – Normal (blue sky) operations	19
2-5	Recommended thermal conditions for buildings located in cold/Arctic climate – Emergency (black sky) operations	20
4-1	Window insulation standards	29
4-2	Insulation standards for cold regions	29
4-3	Climate Zone 8 thermal resistance requirements	30
4-4	Building envelope characteristics for mass and frame buildings located in cold and arctic climates used for study of interior temperature decay when heating is interrupted	46
8-1	Parametric study results for the maximum allowable time to repair	89
A-1	USACE airtightness testing at Alaskan military bases	101
A-2	Small, medium & large construction airtightness results (2009-2020)	104
B-1	Thermal decay test timeline and environmental conditions	119
B-2	Simulation results	131
B-3	Simulation results by room and floor (-60 °F [-51 °C])	139
B-4	Building parameters that are different, and MaxTTR for constant low outdoor temperatures (ODB)	141

Foreword

Thermal energy systems resilience is especially important in extreme climates. While metrics and requirements for availability, reliability, and quality of power systems have been established (DoD 2020), similar metrics and requirements for thermal energy systems are not well understood despite a clear need in earth's cold regions.

Thermal energy systems addressed by this Guide consist of both the demand and supply side. The demand side is comprised of active and passive systems including thermal demand by the process; heating, ventilating, and air-conditioning (HVAC) systems maintaining required environmental conditions for the building's operations and comfort for people; and a shelter/building that houses them. The supply side includes energy conversion, distribution, and storage system components. Requirements to maintain thermal/environmental conditions in the building (or in a part of the building) needed for housing critical mission-related processes and for occupants include criteria to maintain thermal comfort and health, to support process needs, and to prevent mold, mildew, and other conditions that can damage building materials or furnishings.

In one of the first-of-its-kind attempts to address a deficiency in our ability to monitor and model thermal decay in cold environments, a thermal decay test (TDT) was envisioned, developed, and conducted by a team of Engineer Research and Development Center (ERDC) researchers with collaborators from the University of Alaska, Fort Wainwright, Fort Greely, and Alaska Thermal Imaging, LLC to better understand the level of reliability required for energy supply systems that can support environmental conditions required for the facility's mission, comfort of people, and sustainment of a building in arctic environments under predominant threat scenarios. The TDT included testing the reliability of the thermal systems in real time under actual extreme conditions (in extreme temperatures, down to -40 °F (-40 °C) and high winds up to 62 mph (100 kmph), summer and winter air leakage tests, and the build out of a model to better forecast future cases and vulnerable failure mechanisms. Based on field studies, a reliable building model has been developed to identify the maximum allowable time available to correct any problems with energy supply to mission critical facilities for different facility archetypes (building mass and insulation characteristics) and air leakage rates before the indoor air temperature reaches habitability or sustainability thresholds.

During an emergency (black sky) situation, requirements of thermal parameters for different categories of buildings or even parts of the building may change. When normal heating, cooling, and humidity control systems operation is limited or not available, mission critical areas can be conditioned to the level of thermal parameters required for supporting agility of personnel performing mission critical operation, but not to the level of their optimal comfort conditions. Beyond these threshold (habitable) levels, effective execution of a critical mission is not possible and mission operators have to be moved into a different location. The Guide establishes these threshold limits of thermal parameters that may be in a broader range compared to that required for thermal comfort, but not to exceed levels of cold stress thresholds: in a heating mode, air temperature in spaces with mission critical operations should be maintained above 60.8 °F (16 °C) (ACGIH 2018).

Prescriptive guidelines for thermal insulation in the design of buildings in cold climates have traditionally been derived by a holistic consideration of climatic factors, energy policy, environmental policy, and economics. The differences in thermal barrier requirements in buildings across the Arctic and Subarctic regions of the world are as influenced by the differing priorities of the governing bodies

that set these requirements as they are on actual physical demands and conditions. Usually, national requirements for building envelope characteristics, e.g., thermal insulation values of its components, building envelope air tightness, vapor permeability, building mass, detailing, etc., are based on economic and environmental considerations. Thermal energy system resilience consideration brings another dimension to the optimization process of these parameters. This Guide summarizes best practice requirements to the building envelope characteristics for buildings located in cold and arctic climates of the United States, Canada, and Scandinavian countries and compares the effect of different levels of building envelope efficiency and mass on indoor air temperature decay when heat supply is interrupted.

Arctic climates provide unique challenges for designers of HVAC, plumbing, and thermal energy systems. The importance of considering the operation outside air temperatures, system reliability, and building resiliency cannot be understated. This Guide describes best practice examples of robust and reliable systems with the emphasis on their redundancy, durability, and functionality. It also discusses the most common heating system and ventilation system approaches used in arctic climate and emphasizes the importance of a maintenance program that allows building operators to successfully troubleshoot and maintain buildings in the arctic. Concepts are illustrated by several best practice examples, e.g., U.S. military bases in Alaska and Søndre Strømfjord and the international airport of Greenland that previously was used as a U.S. military base.

This Guide is designed for energy systems designers, architects, energy managers and building operators and is a valuable resource for those who are involved in building planning and operation in cold and arctic climates. This Guide, with its focus on resilience of thermal energy systems, is meant to complement the *ASHRAE Cold-Climate Buildings Design Guide, Second Edition* (ASHRAE 2021).

Acknowledgements

The Guide results from experts' discussions during the Consultation Forum "Thermal Energy Systems Resilience in Cold/Arctic Climates" (ERDC 2020) and research conducted under the IEA EBC Annex 73, the Environmental Security Technology Certification Program (ESTCP) Project "Technologies Integration to Achieve Resilient, Low-Energy Military Installations" and U.S. Army Program project 633734 under Military Engineering Technology Demonstration.

The authors would like to thank the members of the ASHRAE Multidisciplinary Task Group, Cold Climate Design Guide, and the Resilience and Security ASHRAE Technical Committee 2.10 and the following individual reviewers for providing valuable comments and suggested improvements to this Guide: Paul Volkman (Senior Energy Program Manager, Office of the Assistant Secretary of the U.S. Army (Installations, Energy & Environment), Dr. Eva B. Moller (professor at the Technical University of Denmark), Dr. Martin Kotol (assistant professor at the Technical University of Denmark), Robert Bean (Calgary, Canada), Meli Stylianou (Natural Resources Canada), Dr. Kemal Gani Bayratar (Turkish Society of HVAC & Sanitary Engineers, Turkey) and Dr. Peter Simmonds (Building and Systems Analytics, U.S.A.). The authors gratefully acknowledge William J. Wolfe, Writer-Editor, ERDC-ITL for his help in coordinating the preparation of this document, and Haley Nelson, Cold Climate Housing Research Center for the cover artwork. We are grateful to Dr. Natasa Nord (professor at Norwegian University of Science and Technology) Dr. Matthias Haase (senior research scientist at SINTEF Building and Infrastructure), Dr. Eva B. Moller, and Ari Laitinen (research scientist at VTT Technical Research Centre of Finland) for their generous contributions regarding the Scandinavian national building codes. Special thanks for financial and other support for this work are owed to the office of the Assistant Secretary of the U.S. Army for Installations, Energy, and Environment; the Environmental Security Technology Certification Program (ESTCP), U.S. Army Corps of Engineers; The Air Barrier Association of America (ABAA) and Design Alaska, Inc., Fairbanks.

THIS PAGE INTENTIONALLY LEFT BLANK

CHAPTER 1. INTRODUCTION

1.1 Traditional parameters of cold climate construction

The U.S. Department of Energy (DOE) classifies locations with more than 5,400 HDD (65 °F) [3,000 HDD (18 °C)] as “cold” (zone 6), and any area with more than 9,000 HDD (65 °F) [5,000 HDD (18 °C)] as “very cold” (zone 7). Places with more than 12,600 HDD (65 °F) [7,000 HDD (18 °C)] are considered “subarctic” (zone 8). The problem with using these climate zones to discuss “cold climates” is that the “cold” designation applies to both Des Moines, IA with 6,426 HDD (65 °F) [3,570 HDD (18 °C)]; and Utqiagvik (Barrow), AK with 18,996 HDD (65 °F) [10,553 HDD (18 °C)]. The climate specific construction requirements for Utqiagvik are significantly different from those of Des Moines. Codes for cold climates are often diluted by the “warmer” end of cold climate. This document focuses on the “colder” end of the cold climate spectrum, i.e., areas with greater than 8,000 HDD (65 °F) (4,500 HDD [18 °C]).

1.2 Alaska –A case study

Alaska is a land of extremes with high summer temperature spikes and extensive periods of cold temperatures and darkness during the winter. In cold climates the indoor environment can be a welcome relief for occupants. For many, there are more hours spent indoors than outdoors during the winter months. Creating a healthy indoor environment with comfortable, reliable, and sustainable spaces and resilient energy supply systems is a high priority and design decisions should consider the life cycle cost effectiveness of building and energy systems holistically, including current and future anticipated functions.

Alaska is the case study for cold climates; it encompasses all three DOE cold climate zones (Figure 1-1). Because Alaska is an arctic state, Alaskans add a fourth zone, Climate Zone 9 or “Arctic,” which includes areas with greater than 16,800 HDD (65 °F) [9,300 HDD (18 °C)] (Alaska Housing Finance Corporation 2018a,b). Climate Zone 9 is a unique place; construction in the Arctic requires specialized design if it is going to remain functional in the long term.

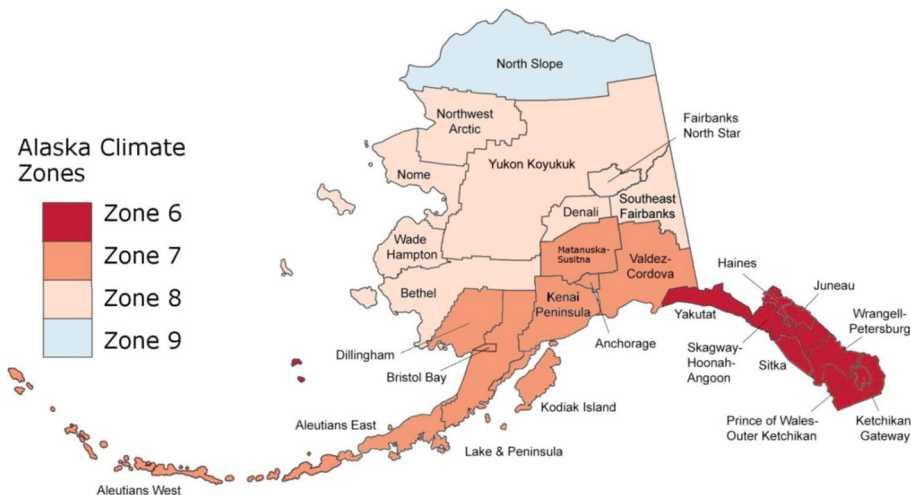

Source: Alaska Housing Finance Corporation 2018a,b.

Figure 1-1. Alaska climate zones.

1.3 Weather considerations

Very cold temperatures drive building design in cold climates. For people to survive in the cold, buildings that are warm and comfortable are essential. A tight, warm building envelope goes a long way toward mitigating the effects of cold, harsh weather. Quality building envelopes are also imperative for resiliency; if there is a disruption in services (which can be quite common in the remote Arctic) the building envelope is the first defense against facility failure. Tight building envelopes create extra requirements for ventilation and may necessitate heat recovery. Ventilation with heat recovery capability is important in cold regions as it lowers heat loss and improves building efficiency. The use of operable windows or “natural ventilation,” though code compliant, is not a viable solution during the winter months.

Mechanical systems need to be able to handle the effects of freezing temperatures: automatic defrost cycles in ventilators are necessary to prevent frost build up, the location of exterior exhaust hoods need to be carefully chosen to limit ice buildup on and above walkways, personnel doors, and vehicle entries, and intake and exhaust penetrations need to have adequate screen opening sizes and configurations to prevent frost and blowing snow from blocking them. Tight, heavily insulated buildings often have enough internal heat gain to require cooling in the warmer months. Well water cooling, ammonia absorption, and vapor-compression refrigeration are all options.

Extreme cold exterior temperatures create low relative humidity inside buildings. Ten percent relative humidity is not uncommon in commercial buildings that are not humidified. Low humidity (less than 25%) can create human health problems like increased spread of bacteria and viruses, respiratory infection, allergic rhinitis, and asthma (Sterling et al. 1985). Low humidity also creates excess static electricity, which is dangerous to sensitive electronics. Proper humidification is energy intensive, requires regular maintenance, and is difficult to achieve at low outdoor temperatures, but is often necessary. Humidification must be coupled with appropriate building envelope design including inspection and/or envelope commissioning during construction. Systems design should include controls that offset the indoor relative humidity setpoint based on outdoor air temperature (ASHRAE 2021). Many warm climate conventional wall and roof designs fail in cold climates due to the extreme vapor drive at low winter temperatures (Craven and Garber-Slaght 2012). Thermal bridges through walls and ceilings need to be avoided as higher indoor humidity can result in dew or frost occurring on surfaces where thermal bridging occurs. It is highly recommended that facilities or portions of facilities that are actively humidified have a detailed hygrothermal analysis completed by a design professional for all building envelope components. Building indoor positive air pressure should be kept to a minimum to avoid forcing warm humidified air into wall or ceiling cavities where condensation and frost buildup can occur. Where facilities have isolated rooms that are humidified, such as operating rooms or data centers, humidity migration to the surrounding spaces should be limited through the use of internal vapor barriers, sealed vestibules, or by using a box-within-box design layout. This will not only reduce the energy used in the humidification process but will also limit humidity exposure to the exterior envelope. Humidification in improperly designed and/or installed envelopes can lead to the generation of mold, which can have a significant negative impact on indoor air quality.

In addition to very cold temperatures, frozen and freezing precipitation are also building design drivers in subarctic and arctic regions. Local snow depth and potential snow drifting should determine the structural design of the roof. The amount of snow and prevailing winds along with wind speed can complicate the location of exterior penetrations. Ventilation hoods need to be specially designed for

use in environments with blowing snow. Snowflake crystals fracture when transported by winds and become small particles that can penetrate small openings in building envelopes and accumulate in ventilation hoods. Strong winds in far northern (tundra) areas of Alaska only enhance the need for strict air tightening requirements for buildings in the Arctic.

Extreme weather events in arctic locations can exacerbate failures. Rapid climatic warming in the Arctic is leading to more extreme weather events (U.S. Climate Resilience Toolkit 2017). Many locations in Alaska are currently receiving more precipitation, which calls the current snow load design code for building roofs into question. Other locations are much drier, which lead to more wildfires and the need to design and redesign buildings and sites to be resilient to fast and large wildfires (Federal Emergency Management Agency 2008). River and coastal locations are prone to flooding and erosion due to increased precipitation, loss of vegetative cover from wildfires, and loss of winter sea ice. Site selection and building planning should consider the flood potential of a specific location (Jones 2017).

1.4 Remote locations challenges

Many locations in Alaska are very remote, which creates unique challenges. The logistics of construction and maintenance in such remote locations is unique and can be daunting. For example, many remote locations in Alaska may have only one or two barge deliveries in the summer; the rest of the year, those locations are accessible only by airplane, snowmobile, or not at all. Even in locations normally accessible by road and airplane, extreme weather events (winter storms and avalanches) can make these locations inaccessible for several days at a time. In some areas, ice roads are constructed annually to move materials and equipment during the winter to some remote communities and industrial areas. Heavy construction equipment is not often available on site and must be shipped by barge. It can be difficult to find room and board for construction crews in smaller communities; for larger projects, this often creates a need to bring in construction camps. Transportation of replacement parts and equipment to remote locations can affect the original system design. For instance, it may be more desirable to use a cast iron sectional boiler or a series of smaller boilers rather than a large water-tube boiler. Technical maintenance expertise is generally not available at remote sites; such personnel must be flown in from urban areas to resolve issues. Straightforward uncomplicated designs allow local maintenance personnel to make repairs more easily.

Shipping costs make fuel to provide electricity and heat expensive at remote sites. For example, heating fuel in a remote village in Alaska can be 2-5 times higher than fuel in larger cities like Fairbanks or Anchorage. The use of static resiliency measures, such as a robust building envelope design, makes sense not only from the standpoint of mission operation, but also from simple economics; such designs significantly reduce long-term operational costs. Balancing energy efficiency with robustness in all building system designs makes remote facilities more resilient and reduces the need for costly fuel.

The remoteness of many locations in Alaska is a major factor for installation resilience. Designs must include redundancy in critical infrastructure to ensure minimal operating conditions under all equipment failure scenarios. This includes power, fuel, and heating systems, and in some situations water and sewer utilities. It can also be critical to maintain communication systems to allow for monitoring and diagnosis of remote systems. For example, Wi-Fi networks are now being leveraged with live video streaming services to allow remote technicians to walk local operators through emergency repairs.

Utility infrastructure in remote communities can be prone to failure. Most communities have a single power plant and limited redundancy in their power distribution network. In addition to power outages, it is not uncommon for the utility power to experience high and low voltage conditions as well as loss of phase events. In addition to standby power generation, critical infrastructure and control systems should consider the use of devices such as over/under voltage protectors, phase loss monitors, and general power conditioning through the use of uninterruptible power supply (UPS) equipment.

It is important to consider location logistics when specifying equipment for remote locations. It is best to use equipment with a track record in the area and equipment someone in the area already knows how to repair. Getting parts to keep equipment running can take months. Supply lines are long and not always functional. Equipment installed in remote locations should be as robust as possible.

Many materials do not work well in extreme cold; they become brittle and prone to failure (Jacobson 1965). Equipment that needs to function outdoors should be designed and tested to handle very low temperatures (-40 °F [-40 °C] and colder). Most manufacturers do not test their equipment and materials under extreme low temperatures so direct contact with the manufacturer is sometimes required to fully vet a product. It is preferred to shelter equipment in extreme temperature locations inside the building envelope or within temperature-controlled structures to not only ensure its operation but also to extend the life of the equipment and to facilitate maintenance.

1.5 Seismic considerations

The very foundation of Alaska is in constant movement. Most of central and southern Alaska is underlain with seismic faults (Figure 1-2). These faults have produced some of the largest earthquakes in the world in the past 100 years and the majority of U.S. earthquakes greater than magnitude 5 have occurred in Alaska (Alaska Earthquake Center 2020). Buildings designed for Alaska need to conform to strict structural codes and guidelines so that they can withstand most earthquakes (Municipality of Anchorage 2018).

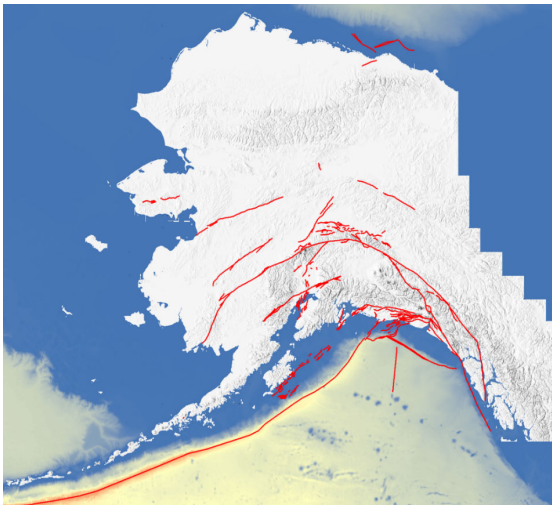

Credit: Adrian Bender, USGS, Alaska Science Center. Public domain. (https://prd-wret.s3.us-west-2.amazonaws.com/assets/palladium/production/s3fs-public/styles/full_width/public/thumbnails/image/Alaska_fault_model_10-11-2018_Adrian_Bender_1.png)

Figure 1-2. Fault lines in Alaska.

1.6 Permafrost considerations

Alaska has seasonally frozen and permafrost soils (where “frozen” is defined as colder than 31 °F [-1 °C]). Permafrost soils occur when soil or rock remains frozen for 2 or more years. Discontinuous permafrost is laterally discontinuous, meaning it includes numerous permafrost-free areas that decrease in size and number from south to north. North of the discontinuous zone, continuous permafrost is present almost everywhere below the land surface except under lakes and rivers that do not freeze to the bottom. In Alaska, there is a transition from seasonally frozen soils to discontinuous permafrost (subarctic) to continuous permafrost (arctic) from the southern coastal areas of Alaska to Alaska’s north slope (see Figure 1-3). For both seasonally frozen and permafrost soils the surface layer that undergoes an annual freeze-thaw cycle is referred to as the active layer (Figure 1-4). In seasonal frost locations it is the depth of freeze and for permafrost locations it is the depth of thaw.

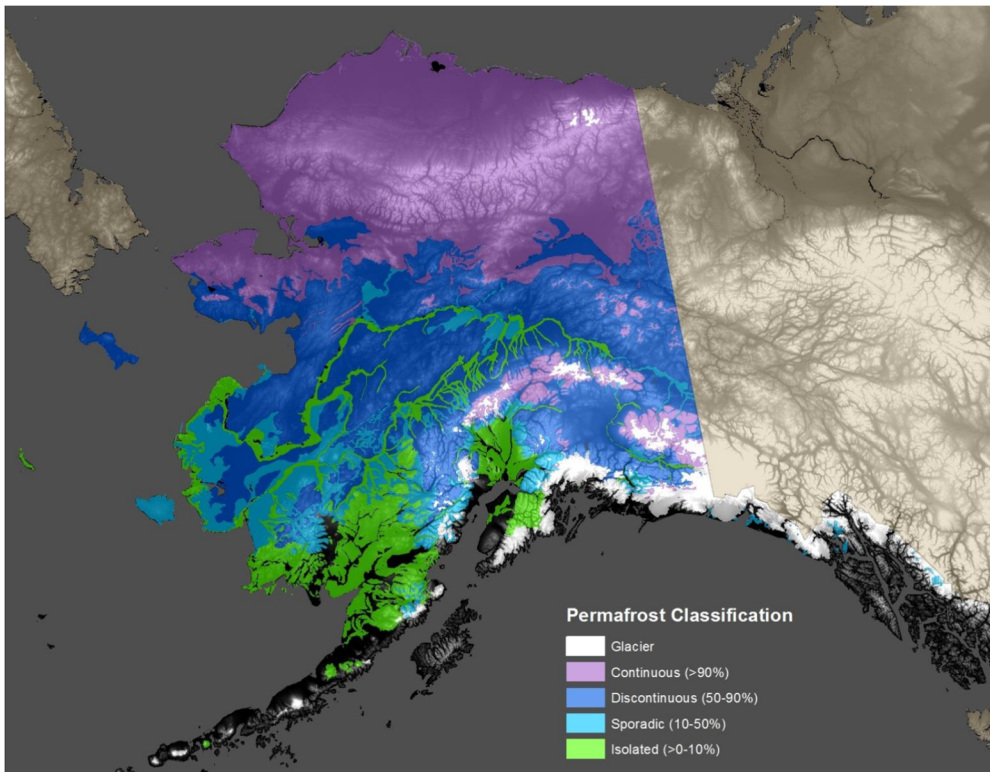

Source: C. Hiemstra, CRREL Modified from Brown and others, 1998 by the U.S. Arctic Research Commission Permafrost Task Force Report (2003)

Figure 1-3. Permafrost distribution in Alaska.

Geotechnical site exploration is required for successful foundation design. In most cases, this requires drilling and retrieval of core samples along with laboratory analysis of the cores. Soil type, dry density, and moisture content are the minimum data required for thermal analysis of the in-situ soils. It is advised to retain a geotechnical engineering firm familiar with frozen soil mechanics and permafrost. If frozen soils or ice are encountered below the active layer when drilling, then it can be concluded permafrost has been encountered. Soil temperature measurements along the depth of the hole or below the depth of zero annual amplitude are often conducted for further evidence to the occurrence of frozen soils during the coring process.



Source: T. Douglas (ERDC-CRREL)

Figure 1-4. The seasonally thawed “active layer” (dark brown surface soil) and underlying permafrost along a coastal bluff near Utqiagvik, Alaska.

Frozen soils are often ice-rich. This means that when the frozen soil is thawed there is water in excess of the thawed void volume. Ice-rich soils will exhibit thaw settlement as they thaw: water drains away and the soil consolidates. This is one of the major challenges with respect to foundation design for buildings in subarctic and arctic locations with underlying ice-rich permafrost.

Two general types of foundations are used for permafrost sites: on-grade or above ground. On-grade foundations usually consist of a floor slab, a layer of non-frost susceptible (NFS) material, a layer of insulation covered by a protective membrane, followed by another layer of NFS material over the in-situ frozen soils. Below the insulation layer, a refrigeration system is usually installed to prevent the permafrost from thawing. Common refrigeration systems include

1. Vapor-compression mechanical refrigeration with a piping grid beneath the insulation, similar to ground source heat pump systems.
2. Air ducts installed beneath the insulation with fans that move outdoor air through the ducts whenever outdoor air temperature is colder than subgrade temperature. In this case, thawing below the insulation does occur during the summer months but the NFS pad below the insulation is thaw-stable and its thickness is sufficient, so the thaw front does not reach the underlying ice-rich permafrost soils.
3. Thermosyphon systems that passively remove heat from below the insulation whenever the air temperature is colder than the subgrade temperature. Thermosyphon system designs are similar to air ducts systems as summer thawing occurs below the insulation within the NFS pad. Thermosyphons

consist of a sealed pipe charged with a pure working fluid such as carbon dioxide or ammonia. The lower end of the pipe contains the liquid phase of the working fluid, the middle includes an evaporator section, and the upper end contains the vapor phase, condenser section. Heat from the ground causes some of the liquid to evaporate, which then travels as a vapor to the above-ground or upper section where it condenses due to the cooling effect of the colder ambient air. Cold condensate then returns to the evaporator section via gravity to complete the cycle.

The alternative to on-grade foundations with insulation and refrigeration are above-grade designs. Foundation support systems are typically either post and pad or piles. The design concept is that heat passing through the insulated floor of the building will be carried away by winter winds and will not warm the ground surface beneath the building, which could lead to thermal degradation of the permafrost. The footprint of the building shades the ground from solar radiation, which is a thermal plus. Care must be exercised to avoid snow accumulation beneath the building as the snow tends to insulate the ground from ambient temperatures. For the post and pad support systems, the foundation pads are typically concrete or treated timber with the posts constructed from treated timber or steel. In cases where there are potential thaw settlement issues the posts are designed to be adjustable to maintain a level foundation. In ice-rich permafrost, friction piles are usually deployed. These are generally steel pipe piles for buildings and are typically installed in predrilled oversized holes. Sand slurry is placed in the annular space between the pile and the hole. In warm permafrost, adequate time must be allowed for the slurry to “freeze back” before loading the pile.

If the active layer for a seasonally frozen or permafrost site is a frost susceptible soil, then it will likely frost heave over the course of a winter. Frost heave is the capillary movement of water to the freezing front and the formation of ice lenses (segregation ice). Since frost heave is never uniform, it results in differential movement and lifting forces on conventional and pile foundations. In seasonal frost locations, frost heaving damage can be minimized if an NFS soil is used beneath the foundation, good surface water management is practiced, and proper use of subgrade insulation is applied (HQUSACE 2004) so building heat prevents frost penetration below the foundation. Upward frost heave forces and potential lifting of a pile foundation can be mitigated by anchoring the pile, breaking the bond between the active layer and the pile, increasing the load on the pile, minimizing the surface area of the pile in the active layer zone, and ensuring proper use of NFS material.

1.7 Conclusions

Infrastructure design for cold climates requires special attention to extreme weather, but also to remote locations and frozen soils. In cold climates, for resilient infrastructure requires planning well beyond the typical resiliency planning for infrastructure in more moderate locations. Building envelopes are the first defense against harsh cold climates; they can be designed and built in a way to increase building resiliency. Mechanical systems must be designed with cold climates in mind; some equipment simply does not work in the cold and getting repairs in remote locations is not quick or easy. Resilient mechanical and energy systems for cold climates usually require backup equipment.

CHAPTER 2. REQUIREMENTS FOR BUILDING THERMAL CONDITIONS UNDER NORMAL AND EMERGENCY OPERATIONS IN COLD AND ARCTIC CLIMATES

2.1 Introduction

This chapter provides recommendations on thermal and moisture parameters (air, temperature, and humidity content) in different types of buildings under normal and emergency operation conditions in Cold/Arctic climate conditions (DOE Climate Zones 6-8). Three scenarios are considered under normal operating conditions: building/space is occupied, temporarily (2-5 days) unoccupied, and long-term unoccupied (e.g., when a building is hibernated). These thermal parameters are necessary to achieve one or several purposes listed below:

- perform the required work in a building in a safe and efficient manner,
- support processes housed in the building, and
- provide conditions required for a long-term integrity of the building and building materials.

Many emergency conditions may occur in the life of a building. This chapter will limit the emergency conditions to interruption of fuel, steam, hot water, and electrical service leading to the interruption of space-conditioning for the building.

During an emergency situation, requirements of thermal parameters for different categories of buildings or even parts of the building may change. When the operation of normal heating, cooling, and humidity control systems is limited or unavailable, mission critical areas can be conditioned to the level of thermal parameters required to support the agility of personnel who perform mission critical operations, but not to the level of optimal comfort conditions. Beyond these threshold (habitable) levels, effective execution of critical missions is not possible and mission operators have to be moved into a different location. These threshold limits of thermal parameters may be in a broader range compared to those required for thermal comfort, but not to exceed levels of heat and cold stress thresholds. However, special process requirements (e.g., with IT and communication equipment, critical hospital spaces, etc.) should be given a priority if they are more stringent. Broader ranges of air temperatures and humidity levels in building spaces surrounding mission critical areas may be used, but they need to be limited to prevent excessive thermal losses/gains and moisture transfer through walls and apertures not designed with thermal and air/vapor barriers. Finally, non-critical standalone buildings can be hibernated, but necessary measures should be taken, and the thermal environment should be maintained (sustainability threshold level) when possible to prevent significant damage to these buildings before they can be returned to their normal operation.

2.2 Normal (blue sky) operating conditions

Under normal operating conditions, for any given building, factors like building envelope insulation and air tightness, ventilation rates, thermostat setpoints, plug loads and lighting levels have a significant impact on building energy consumption and cost.

It is important that engineers and operations and maintenance (O&M) personnel design for and use appropriate rates and setpoints to maintain these thermal conditions, which provide occupant comfort, health, and productivity, and which minimize energy usage in normal operation conditions and make thermal systems more resilient during emergency operation. Setting these rates and setpoints can be as much of an art as a science, but there are a number of standard references that are used to help in the operation of the building. The following references provide guidance on the suggested values.

Thermal requirements include criteria for thermal comfort and health, and process needs; criteria for preventing the freezing of water pipes, growth of mold and mildew; and criteria for preventing other damage to the building materials or furnishings. Under normal operating conditions, code compliant buildings are presumed to be free of mold and mildew problems; if these conditions do occur, they become matters for O&M intervention.

Thermal comfort and health criteria primarily involve the temperature and humidity conditions in the building. If temperatures are too high, occupants will be uncomfortably warm. If temperatures are too low, occupants will be uncomfortably cold. The wrong humidity (rooms typically do not have humidistats) means that occupants feel damp or sweaty or too dry. Thermal comfort is defined by ASHRAE Standard 55, *Thermal Environmental Conditions for Human Occupancy* (ASHRAE 2017a).

The following dry bulb room air temperatures and relative humidity values (IMCOM 2010) are within the ASHRAE Standard 55 range and should not be exceeded:

Cooling Period: The dry bulb temperature (DBT) in occupied spaces should not be set below 70 °F (21 °C) with the relative humidity (RH) maintained below 60%. When the space is unoccupied during a short period of time (e.g., few days), the room thermostat should be reset to 85 °F (29 °C) with the RH maintained below 70%. In spaces unoccupied for an extended period of time (e.g., weeks), temperature should not be controlled but the building air RH should be maintained at 70%

Heating period: RH of all building air should be maintained below 50% and above 30% at all times (unless required differently for health reasons at hospitals or daycare facilities or required by processes). Examples of DBT in occupied spaces not to be exceeded include:

- Barracks and other living quarters: 70 °F (21 °C) Monday through Friday from 5 a.m. to 11 p.m. and 65 °F (18.3 °C) from 11 p.m. to 5 a.m. Temperature settings for barracks Saturday and Sunday 70 °F (21 °C) from 6 a.m. to 11 p.m. and 65 °F (18.3 °C) from 11 p.m. to 6 a.m..
- Offices, warehouses, etc., where personnel work seated or in a standing position involving little or no exercise: 70 °F (21 °C) during working hours and not more than 55 °F (12.8 °C) during non-working hours.
- Childcare facilities: 72 °F (22.2 °C) during working hours.
- When the space is unoccupied during a short period of time (e.g., few days), the room thermostat should be set back to 55 °F (12.7 °C). In spaces unoccupied for an extended period of time (e.g., weeks), temperature should be controlled at 40 °F (5 °C).

Process related criteria include temperature and humidity needed to perform the process housed in the building (e.g., spaces with IT and Communications equipment, critical hospital areas, industrial processes [painting, printing, etc.]). While new design guidance for computer systems indicates a much higher tolerance for high temperatures than previously thought, some specialized electronic and laboratory equipment has fairly tight temperature and humidity requirements for protection

from damage caused by electrostatic discharge. Archival storage of important documents also involves relatively tight tolerances for temperature and humidity.

Many mission critical facilities or dedicated spaces within these facilities (e.g., emergency operation centers, Sensitive Compartmented Information Facilities [SCIFs], Network Operations Centers [NOCs], Network Enterprise Centers [NECs]) house computer systems and associated components, such as telecommunications and storage systems. Environmental requirements for spaces with IT and Communications equipment may vary depending on type of equipment or manufacturer. According to ASHRAE (2005), there are six standard classes of thermal requirements.

Class A1. Typically, a datacom facility with tightly controlled environmental parameters (dew point [DP], temperature, and RH) and mission critical operations, including those housing servers and data storage.

Class A2/A3/A4. Typically, the types of products typically designed for use in an information technology space with some control of environmental parameters (dew point, temperature, and RH), are volume servers, storage products, personal computers, and workstations. Among these three classes, A2 has the narrowest temperature and moisture requirements and A4 has the widest environmental requirements. Classes A3 and A4 do not have special requirements to be considered.

Class B. Typically an office, home or transportable environment with a little control of environmental parameters (temperature only), including personal computers, workstations, and printers.

Class C. Typically a point of sale or light industrial environment with weather protection.

In addition to four classes of requirements for IT and Communications equipment facilities discussed above, there are also requirements for Network Equipment-Building System (NEBS) offices housing switches, routers, and similar equipment with some control of environmental parameters (DP, temperature, and RH). Table 2-1 lists the recommended and allowable conditions for Class A1, Class A2, and NEBS environments.

Table 2-1. Recommended and allowable conditions for Classes A1-A2, and NEBS environments.

Conditions	ClassA1/ClassA2 (ASHRAE 2019a)		NEBS (ASHRAE 2005)	
	Allowable level	Recommended level	Allowable level	Recommended level
Temperature control range				
A1	51 °F - 89 °F (11 °C - 32 °C)	64 °F-80 °F (11 °C–27 °C)	41 °F-104 °F (5 °C–40 °C)	65 °F-80 °F (18 °C–27 °C)
A2	51 °F - 91 °F (11 °C - 33 °C)			
Maximum temperature rate of change	9 °F/hr (31 °F/hr) ¹ (5 °C/hr [2 °C/hr])		2.9 °F/hr (1.6 °C/hr)	
RH control range				
A1	10 °F (-11 °C) DP and 8% RH to 62 °F (11 °C) DP and 80%RH	15 °F - 51 °F DP (-1 °C - 11 °C) DP and 60% RH	5%-85% 82 °F (28 °C) Max DP	Max 55%
A2	10 °F (-11 °C) DP and 8% RH to 69 °F (21 °C) DP and 80%RH			
¹ 9 °F/hr (5 °C/hr) for tape storage, 31 °F/hr (2 °C/hr) for all other IT equipment and not more than 9 °F (5 °C) in any 15 min period of time.				

Health care facilities represent another group of mission critical facilities. Per NFPA 99, Health care facilities include, but are not limited to, hospitals, nursing homes, limited care facilities, clinics, medical and dental offices, and ambulatory health care centers. This definition applies to normal, regular operations and does not apply to facilities during declared local or national disasters. Patient Care Spaces in Health care facilities are described using the following four categories:

- **Category 1 Space.** Space in which failure of equipment or a system is likely to cause major injury or death of patients, staff, or visitors.
- **Category 2 Space.** Space in which failure of equipment or a system is likely to cause minor injury to patients, staff, or visitors.
- **Category 3 Space.** Space in which failure of equipment or a system is not likely to cause injury to patients, staff, or visitors but can cause discomfort.
- **Category 4 Space.** Space in which failure of equipment or a system is not likely to have a physical impact on patient care.

Table 2-2 lists examples of requirements (ASHRAE 2017b) to thermal environment in spaces included in categories 1 and 2.

Table 2-2. Thermal environment requirements for selected spaces in medical facilities.

Space	T °F	T °C	RH, %
Class B and C operating rooms	68-75	20-24	30 to 60
Operating/surgical cystoscopy rooms	68-75	20-24	30 to 60
Delivery room	68-75	20-24	30 to 60
Critical and intensive care	70-75	21-24	30 to 60
Wound intensive care (burn unit)	70-75	21-24	40 to 60
Radiology	70-75	21-24	Max 60

Space	T °F	T °C	RH, %
Class A operating/procedure room	70-75	21-24	20 to 60
X-ray (surgery/critical care and catheterization)	70-75	21-24	Max 60
Pharmacy	70-72	21-22	Max 60

Army Guidelines (IMCOM 2010) provide the following recommendations for space air temperatures for “industrial” spaces during the heating period:

- Issue and similar rooms: 60 °F (15.5 °C).
- Special process rooms, such as paint shops and drying rooms: 80 °F (26.6 °C) allowed, or the one required by the process.
- Shops, hangars, and other buildings where employees work in a standing position or exercise moderately, such as sorting, or light packing or crating: 60 °F (15.5 °C) during the day; 40 °F (4.4 °C) during nighttime.
- Shops, warehouses, and the like, where employees do work involving considerable exercise, such as foundries, heavy packing, crating, and stacking, or where heat is required to protect material or installed equipment from freezing: 40 °F (4.4 °C). EXCEPTION: Localized heat, not to exceed 55 °F (13 °C) may be furnished in areas where the work requires medium or light personnel activity.
- Heat is not permitted in warehouse areas that do not contain material or equipment requiring protection from freezing or condensation, and warehousing of stored goods is the only operation. Heat for the prevention of condensation on stored machinery and material will be supplied after a thorough survey of all conditions and the approval of managers.
- Buildings other than those specified above will not be heated to temperatures higher than 65 °F (18 °C) without approval (in writing) from managers.

The environmental conditions (temperature and humidity) maintained in indoor spaces determines not only the comfort of the occupants of those spaces but also the long-term condition of the building itself. Historically, only the DBT of indoor spaces was controlled to achieve comfortable indoor conditions for the occupants. Little attention was given to control of moisture/humidity in the spaces. As a result, many existing Army buildings have exhibited mold/mildew problems.

Arctic buildings. Eliminating mold growth from surfaces of buildings requires year-round control of both the DBT and the DP temperature (or air RH) in the indoor spaces in hot/humid climates. In arctic climates, even those humidified up to 30% RH indoors should not exhibit mold problems given the low temperature and vapor pressure outdoors. Preliminary transient hygrothermal analysis of common arctic building wall and roof assemblies shows no risk of mold growth except for atypically compromised assemblies. The use of low-permeance insulating materials in wall and roof assemblies presents strong assurance of good moisture performance.

Temperature may be set back in arctic buildings during short- and long-term periods, provided measures are taken to prevent pipe bursting. See Section 2.3 below. This may require keeping the interior of the building heated to 50 °F (10 °C). Setting back temperature does not present a mold risk in arctic climates. Of course, outdoor air to the building should be shut off during unoccupied periods.

2.3 Emergency (black sky) operating conditions

Depending on the emergency situation, the objective for any mission critical area of the given building is to maintain mission critical operations as long as it is necessary or technically possible. As for other,

non-critical building areas and standalone buildings, the objective is to minimize the damage to the asset. It is assumed that building processes are kept operational only in mission critical areas and non-mission critical activities are discontinued. In the mission critical areas/buildings, operations will continue, and processes will require people with critical skills. While under normal circumstances, building environmental controls are designed and operated to create a thermoneutral environment conducive to optimal employee thermal environment discussed in the section under blue sky operating condition. However, should the building environmental controls fail for any reason, the thermal environment may change in such a way as to no longer be optimal for critical workers to perform their jobs. The next section describes threshold indoor environmental conditions beyond which human physical and mental skills can no longer be maintained.

Under emergency (black sky) operations, efforts should be made to maintain the thermal environment to prevent significant damage to both mission critical and non-mission critical buildings before they can be returned back to their normal operation. This may include reducing ventilation requirements, controlling maximum humidity levels using available technologies with minimum fuel consumption; allowing maximum daylight; keeping plug loads on and lowering lighting levels; and in cooling constraint conditions, using window shades to minimize solar gains, to reduce plug loads, and to keep lighting at a minimum level.

Threshold Conditions for Human Environment. While stressful cold and hot environmental conditions are well defined for jobs performed outdoors (NIOSH 2016, ACGIH 2018), there is not much information available for such conditions when jobs are performed indoors. This section addresses the potential thermal “inflection point,” i.e., when a person can no longer physiologically and behaviorally compensate for the thermal stress while on the job, based on the following assumptions and conditions:

1. The building environmental control systems fail and cannot be restored over a period of hours to days.
2. The occupants of the building must stay in that building to perform their jobs (i.e., cannot leave to move to more comfortable conditions).
3. The building occupants do not have access to clothing that can provide anything more than minimal protection against either cold or hot conditions (at most a clothing insulation [Clo] \leq 1.0).
4. The building occupants are generally healthy with the normal physiological responses to deviations in environmental conditions.
5. The workers remain inside the building and perform minimal physical work (nearly at rest, the energy generated inside the body due to metabolic activity 1.2-1.5 MET).^{*} At this minimal workload, the metabolic heat produced will be minimal (slightly above that produced at rest).
6. Factors such as convection and direct radiation from the sun will be considered negligible.
7. Air movement in the building occupied zone is below 0.7 ft/min (0.2 m)/min and, as such, there is little convective heat transfer.
8. Building is lit using either fluorescent, or LED lighting, which results in a negligible radiant heat from lighting fixtures.
9. The building environmental conditions will be affected as a result of the function of the HVAC system in an indoor setting, and that the environmental stressors are the dry air temperature (dry bulb or T_{db}) and humidity or wet bulb temperature (T_{wb}) with other environmental factors such as air velocity and radiant heat being negligible.

^{*} A MET, or “Metabolic Equivalent of Task,” is a ratio of an individual’s working metabolic rate relative to resting metabolic rate.

Humans have evolved the ability to maintain a stable internal (core) temperature (T_{core}) in the face of environmental thermal extremes through physiological, biophysical, and behavioral means. Maintenance of a stable T_{core} involves a tight balance between heat gain and heat loss to the environment during exposure to either cold or hot environments. A detailed discussion of the physiological and behavioral responses to thermal extremes is beyond the scope of the present work. However, note that, although there are strong physiological and behavioral mechanisms for maintaining T_{core} , these can be overcome under severe thermal stress – especially if that thermal burden is prolonged.

Physiological response. The physiological responses, and the rate and magnitude at which they occur, will depend on the rate and magnitude of the change in the environmental temperature and, to a greater (hot temperature) or lesser (cold temperature) extent, the RH of the air. The rate of change in the building environment in which environmental controls have failed will depend on the insulating properties of the building, i.e., the rate and magnitude of the change in temperature and RH. The physiological responses will also depend to a large extent on the degree of personal insulation (clothing) the worker has to protect against the decrease in environmental temperature.

A “normal” core body temperature, T_{core} , is considered to be 98.6 °F (37 °C). It is at this temperature that optimal physiological function occurs. The physiological consequences (i.e., ΔT_{core}) from a decrease or an increase in environmental temperature can be severe. If the physiological responses to environmental temperature changes (and the ability to maintain T_{core}) are unsuccessful, then T_{core} will change (either decrease or increase); if the change is large enough, then normal function will be compromised. For example, a T_{core} of 96.8 °F (36 °C) is considered the onset of hypothermia. At T_{core} <95 °F (35 °C) one becomes symptomatic. Physiological/Psychological Signs and Symptoms of hyperthermia are:

- Extreme discomfort
- Numbness (tactile sensitivity, manual dexterity decreases)
- Shivering
- Skin vasoconstriction (blanching)
- Cold becomes a distraction
- Muscle stiffness
- Cognitive changes (confusion, apathy, loss of attention, reduced memory capacity, etc.)
- Loss of sensory information (blurred vision)
- Cardiovascular effects
- Loss of consciousness.

It is important to understand that probably the first line of defense against cold is clothing that creates an insulative layer that protects the humans from cold environments. With this strategy, a human being may perform activities in a cold (41 °F [5 °C]) environment but be “exposed” to a microenvironment (the layer of air that exists between the surface of the skin and the inner surface of the clothing) that is the equivalent to a mild temperature (~71.60 °F [~22 °C]). Nevertheless, working in cold environments has demonstrable effects on humans even if wearing relatively warm clothing. Early studies of the thermal effects on human performance focused on the frequency of industrial accidents that could be related to ambient temperature. The rate of industrial accidents could be described as a “U” curve in that the lowest frequency of accidents occurred at a temperature of ~68 °F (~20 °C) and increased as the ambient temperature either decreased or increased from

68 °F (20 °C). The frequency of industrial accidents increased to almost 140% as the temperature decreased from 68 °F to ~50 °F (20 °C to ~10 °C) indicating cold temperatures had a significant effect on worker ability to perform their tasks safely. The decline in manual dexterity begins at a T_{sk} of 53.1 °F – 60.1 °F (12 °C–16 °C). Tactile sensitivity declines steeply below 46 °F (8 °C). This may severely limit the use of computers and other equipment that requires the use of both manual dexterity and tactile sensitivity. Similar loss of cognitive function and manual dexterity occurred in hot environments as well (starting at a T_{core} of > 98.1 °F (> 39 °C).

Thermal discomfort often becomes a distraction to the person experiencing it and, hence can affect performance or the so-called “time off task” or time spent not working but addressing the thermal discomfort. The degree of distraction is affected by whether the person can leave the environment or somehow change the environment (changing a thermostat setting) to improve the thermal comfort. If the person has no control over an uncomfortable thermal environment, the degree of distraction or time off task will increase. The distraction occurs as the result of a physiological change, e.g., decrease or increase in T_{sk} , which then results in the focus of attention on that change rather than on the task before them. Distraction is also modulated by motivation such that a more strongly motivated person may be less distracted by cold stimulus than a less motivated person exposed to the same stimulus. In addition, if the person exposed to a cold stimulus perceives that they have no control over the environment and the consequence of not performing the work is high enough, then the cold environment will be less distracting from the necessary work. As can be seen from the previous discussion, the issue of distraction on cognition and job performance is complex.

A compilation of the effects of temperature resulting in the decline in the ability to perform light work (1.2 MET) while wearing light clothing (0.6 clo) has been described in detail elsewhere (Parsons 2003, Wargocki and Wyon 2017). Briefly, the literature indicates that when indoor temperature decreases from 60.1 °F (16 °C) to 51 °F (10 °C), the rate of accidents increases sharply by 40%, manual dexterity rapidly declines by 20%, speed and sensitivity of fingers decline by 50%— all of which would fit the scenario in the present work and would suggest that the ability of workers to perform critical tasks is significantly impaired at temperatures below 60.8 °F (16 °C). Conversely, in workers performing sedentary work (1 MET) while wearing normal indoor clothing (1.0 clo), as the ambient temperature increased from ~75 °F (24 °C) to 77 °F (25 °C), the rate of accidents rose sharply by 50%. In addition, as the ambient temperatures increased from 68 °F to 86 °F (20 °C to 30 °C) mental performance decreased by 40%, and finally, as the ambient temperature increased from 61 °F to 80.1 °F (20 °C to 27 °C) the work rate declined sharply (by 55%). These data show that the ambient temperature can significantly affect the ability of workers to perform tasks if the exposure lasts long enough.

Therefore, in emergency situations, reducing indoor air temperature in spaces with mission critical buildings operation below 60.8 °F (16 °C) (ACGIH 2018) and increasing Wet Bulb Globe Temperature (WBGT) above 87.8 °F (31 °C [ACGIH 2017]) is not recommended since it will impair the performance of mission operators.

Arctic buildings under emergency conditions. Arctic climates present a low risk of mold growth on building surfaces. Mold does not grow at low temperatures. In addition, arctic outdoor vapor pressures are very low, so without humidification, indoor RH will be quite low. Mold growth depends greatly on the sensitivity of a surface to growth, and surfaces made of organic materials such as wood and products with paper facings offer the primary potential for mold growth in arctic climates—not metal, concrete, or masonry. Preliminary modeling studies, using humidification at 30%, in Climate

Zones 6, 7, and 8, show surface RH remaining at 65% or below, while mold requires surface RH above 85% in most cases.

Aside from water problems associated with roof or plumbing leaks, the greatest risk of mold growth may be from cold thermal bridges in humidified buildings. Thermal bridges may be identified using infrared (IR) thermography.

In arctic climates, if building climate control is suspended in the short or long term, then mold growth is unlikely to occur. Normally, downward drift of temperature will occur with suspension of the operation of the air handler. This means that the indoor air temperature will decline as a function of the outdoor air temperature, the thermal insulation, the airtightness of the building, and the heat storage by the contents of the building. Also, during a heating period, the outdoor absolute humidity will be lower than the indoor absolute humidity, so it will drift downward at a rate governed primarily by the airtightness of the envelope. Under most conditions, the downward drift of absolute humidity will be much more rapid than the downward drift of DBT, and as a consequence, the indoor RH will be low during the drift period. The downward drift of absolute humidity is considered rapid because, with each air change, assuming full mixing, the absolute humidity difference between indoors and out, is halved. Absolute humidity equilibrium with outdoors would be achieved in a matter of hours. The downward drift of temperature would be relatively slow given the low heat content of air, the thermal resistance in the envelope, and the heat storage in interior materials. It would typically be measured in days.

Modeling has provided preliminary estimates of the temperature decay rate of arctic buildings in case of a utility interruption. For a building with average thermal resistance of R-20 (all sides), with an air tightness of 0.25 cfm (0.0001 m³/s) per 75 sq ft (7 m²), and which contains, in envelope and contents, 100 lb/sq ft (0.05 kg/cm²) of envelope, the decay half-life is approximately 1 week. By doubling the thermal resistance or the mass of contents, or by halving the air leakage, the half-life is doubled to 2 weeks. By halving the thermal resistance or the content mass, or by doubling the air leakage measure, the half-life of temperature decay is reduced to 3 to 4 days. Of course, different parts of the building will perform differently.

Pipe Burst Protection. In cold and Arctic climates, hydronic heating systems typically use a glycol/water solution as the heating system fluid (Winfield et al. 2021). To reduce the risk of freezing of water pipes or wet sprinkler systems, pipes should be located in interior walls or plumbing chases. Pipes in exterior walls should be avoided. However, in the emergency situation when heat supply to the building is interrupted, the indoor air temperature can drop significantly. Research at the University of Illinois has illustrated the mechanism by which water pipes burst when surrounded by cold temperatures. Cold air temperatures cause the temperature of water in pipes to decline. Water temperature may decline below 32 °F (0 °C), often to 25 °F (−4 °C). With continued cold temperatures, ice nucleates in the water, raising the temperature of the two-phase mix to 32 °F (0 °C). With continued cold temperatures, ice begins to grow on the pipe wall, growing inward; the rate of ice growth depends on several factors such as air temperature, pipe thermal conductivity, water circulation, and effect of the air film surrounding the pipe. Through this entire process, before the formation of blockage, the pipe system is not put at risk, and with rising air temperatures the system will recover to the original condition with no ill effects.

If the ice grows inward to the point of blockage, then water pressure effects become important. The blockage can grow along the length of the pipe and act like a piston. Piston action toward the water

source will generally have no ill effect, in the absence of a backflow preventer. But piston action toward the remaining liquid water confined downstream will cause the water pressure to rise. Pipe rupture or fitting failure will occur once the water pressure reaches a sufficiently high level.

There are several means to prevent pipe bursting due to freezing:

1. Avoid subzero air temperatures at the pipe.
2. Drain the water from the pipe system. Compressed air may be used for systems that do not drain entirely by gravity.
3. Provide pressure relief at any at-risk portion of the pipe system. A single pressure relief valve is usually sufficient to protect a clustered fixture group. A ballcock assembly in a typical toilet serves as a pressure relief device (which explains the greater likelihood of hot water rupture during freeze events).
4. Provide air expansion (using water hammer arresters for example) to protect piping systems where the slight water leakage from pressure relief valves is undesirable, such as in wet fire suppression systems.

It is particularly important to avoid individual sites of particularly cold temperature along the pipe length, as these are preferred sites for blockage to initiate. Such sites will occur at interruptions in pipe insulation (often at fittings such as elbows) and at air leaks in the envelope, where moving air can reduce the air film thermal resistance. See Appendix A.

2.4 Thermal requirements for unoccupied spaces

Requirements for temperatures and RH discussed above are developed for occupied spaces (Table 2-3). Many buildings are not occupied at night or on weekends. Some military facilities including barracks, administrative buildings, and dining facilities may be unoccupied for an extended period of time due to training and deployment schedules. So, one energy conservation strategy may be to set temperatures back for heating or up for cooling. One source of guidance on set back or set up temperatures is ANSI/ASHRAE/IESNA Standard 90.1, *Energy Standard for Buildings Except Low-Rise Residential Buildings* (ASHRAE 2019). Standard 90.1 does not regulate thermostat setbacks or setups, but it does regulate the capabilities of thermostats installed in buildings. Section 6.4.3.3.2 of Standard 90.1, "Setback Controls," requires that heating systems in all parts of the United States outside of Miami, FL and the tropical islands (that is, Climate Zones 2-8) must have a capability to be set back to 55 °F (13 °C). Heating systems in zone 1 are assumed to have minimal usage and therefore no need of setbacks. Cooling systems in hot dry areas (zones 1b, 2b, and 3b) must have the capability to be set up to 90 °F (32 °C). However, cooling systems in hot and humid climates (zones 1a, 2a, and 3a) are not required to have cooling setbacks due to potential for moisture problems. It is wasteful to cool facilities left unoccupied for an extended period of time, which are located in hot and humid climates. Significant energy savings can be achieved without damage to building materials and furnishings if a combination of measures related to the building envelope and heating, ventilating, and air-conditioning (HVAC) are used to maintain the requirements listed in Table 2-3 for all the areas inside the building.

Table 2-3. DBT and RH requirements for occupied and unoccupied facilities to reduce the risk of moisture related problems.

Occupancy/Use	DP (Setpoint) Not to Exceed	Maximum Dry Bulb Temp (Setpoint)	Minimum Dry Bulb Temp (Setpoint)
Occupied	61 °F (15.6 °C)	75 °F (24 °C)	70 °F (21 °C)
Unoccupied (Short term)	61 °F (15.6 °C)	85 °F (29 °C)	55 °F (13 °C)

Occupancy/Use	DP (Setpoint) Not to Exceed	Maximum Dry Bulb Temp (Setpoint)	Minimum Dry Bulb Temp (Setpoint)
Unoccupied (Long term)	61 °F (15.6 °C)	No Max	40 °F (4 °C)
Critical Equipment	61 °F (15.6 °C) or equip requirement if less	Equip max allowed	Equip min allowed

2.5 Recommendations.

Requirements for thermal environmental condition in buildings are set to achieve the following purposes:

- To perform the required work in a building in a safe and efficient manner,
- To support processes housed in the building, and
- To provide conditions required for a long-term integrity of the building and building materials.

Buildings are designed to meet these three sets of requirements in normal (blue sky) operating condition. Thermal comfort requirements are defined by ASHRAE Standard 55, *Thermal Environmental Conditions for Human Occupancy*. Different processes housed in the building (e.g., spaces with IT and Communications equipment, critical hospital areas, industrial process [painting, printing, etc.]) may have broader or narrower ranges for air temperature and RH, than those for human comfort. In normal operation conditions, environmental requirements based on sustainability of building envelope assemblies and furnishings are not a limiting factor given that the building envelope air barrier and vapor protection are designed to avoid mold growth and water accumulation within the building assembly.

During an emergency situation (black sky), requirements of thermal parameters for different categories of buildings or even parts of the building may change. When normal heating, cooling, and humidity control systems operation is limited or not available, mission critical areas can be conditioned to the level of thermal parameters required for supporting agility of personnel performing mission critical operations, but not to the level of their optimal comfort conditions. Beyond these threshold (habitable) levels, effective execution of a critical mission is not possible and mission operators have to be moved into a different location. These threshold limits of thermal parameters may be in a broader range compared to that required for thermal comfort, but not to exceed levels of heat and cold stress thresholds: in a heating mode, air temperature in spaces with mission critical operations should be maintained above 60.8 °F (16 °C) [ACGIH 2018], and in a cooling mode, the Wet Bulb Global Temperature should be below 87.8 °F (31 °C [ACGIH 2017]).

Special process requirements (e.g., with IT and communication equipment, critical hospital spaces, etc.) should be given a priority if they are more stringent. Broader ranges of air temperatures and humidity levels in building spaces surrounding mission critical areas may be used, but they need to be limited to prevent excessive thermal losses/gains and moisture transfer through walls and apertures not designed with thermal and air/vapor barriers.

In arctic climates, building envelope assemblies are not a limiting factor regarding how indoor climate must be maintained during short- or long-term outages of indoor climate control, unless water piping cannot be drained or otherwise protected against freezing.

In cases where utility supply is interrupted and the building air handler is disabled, the indoor temperature will decay to the outdoor temperature. The rate of decay has been field tested and modeled (Oberg et al. 2021, Liesen et al. 2021); results show that the time it takes for indoor air temperature to reach a threshold (habitable) level or a building sustainability level will range from a few hours to several days depending on thermal resistance, airtightness, and the mass of the building envelope and contents in the building.

To avoid damage to building materials and furnishings in cold and arctic climates DBT should exceed 40 °F (4.4 °C) where water piping is at risk.

Finally, non-critical standalone buildings can be hibernated, but necessary measures should be taken, and the thermal environment should be maintained, when possible, to prevent significant damage to these buildings before they can be returned to their normal operation. Tables 2-4 and 2-5 summarize recommendation to thermal environmental conditions for buildings located in cold and arctic climates for normal and emergency situations.

Table 2-4. Recommended thermal conditions for buildings located in cold/Arctic climate – Normal (blue sky) operations.

Space Occupancy							
Type of Requirement	Occupied			Unoccupied (Short Term)	Unoccupied (Long Term/Hibernated)		
	Normal Operations (Regular Business Hours)			Unoccupied for a Short Time Period (e.g., a Few Days)	Unoccupied for an Extended Period of Time (e.g., Weeks) Building Freezing/ Not Freezing		
	Dew Point Not to Exceed	Maximum Dry Bulb	Minimum Dry Bulb	Dew Point Not to Exceed	Minimum Dry Bulb Temp	Dew Point Not to Exceed	Minimum Dry Bulb Temp
Human comfort	< 63 °F (17.2 °C) ¹	82 °F (27.8 °C) ¹	68 °F (20 °C) ¹	< 63 °F (17.2 °C) ¹	55 °F (12.7 °C) ⁴		N/A
Process driven	Process specific – see examples in Tables 1 & 2			Process specific – see examples in Tables 1 & 2 (unless specified otherwise)			N/A
Building sustainment	Humidity Not to Exceed	Minimum Dry Bulb Temp	Humidity Not to Exceed	Minimum Dry Bulb Temp	Humidity Not to Exceed	Minimum Dry Bulb Temp	
	80% ³	40 °F (4.4 °C) ²	< 80% ³	40 °F (4.4 °C) ²	80% ³	40 °F (4.4 °C) ² , or N/A if drained	

¹ASHRAE Standard 55

²To prevent water pipe rupture, with factor of safety

³To prevent interior surface mold growth, with no factor of safety

⁴To prevent long time recovery and a significant energy losses

**Table 2-5. Recommended thermal conditions for buildings located in cold/Arctic climate –
Emergency (black sky) operations.**

Emergency Space Occupancy							
Scenario	Mission Critical Operation			Tertiary Space (Non-Mission Critical Space Bordering Mission Critical Space)		Hibernated Can Be Unoccupied for Extended Period of Time (from Days to Weeks) Building Freezing/Not Freezing	
	Type of Requirement	DP	Minimum Dry Bulb Temperature	Humidity not To Exceed	Minimum Dry Bulb Temperature	Humidity not to Exceed	Minimum Dry Bulb Temperature
Human comfort	< 63 °F (17.2 °C) ¹	> 60 °F (16 °C) ⁵		N/A			N/A
Process driven	Process specific – see examples in Tables 1 & 2			N/A			N/A
			Humidity not to Exceed	Minimum Dry Bulb Temperature	Humidity not to Exceed	Minimum Dry Bulb Temperature	Humidity not to Exceed
Building sustainment	80% ³	40 °F (4.4 °C) ²	80% ³	40 °F (4.4 °C) ² 55 °F (12.7 °C) ⁴	80% ³	40 °F (4.4 °C) ² or N/A if drained	

¹ASHRAE Standard 55

²To prevent water pipe rupture, with factor of safety

³To prevent interior surface mold growth, with no factor of safety

⁴To prevent long time recovery and a significant energy losses

⁵ACGIH (2018)

CHAPTER 3. PARAMETERS FOR THERMAL ENERGY SYSTEM RESILIENCE

3.1 Introduction

To be able to provide a design that is robust, adaptable, and affordable, it is important to understand the aspects of the geographic location that will impact equipment selections, operating hours, and maintenance needs. Another consideration is the ability of a building to withstand a heating plant outage, either locally or from a centralized source. In this chapter, the term ‘resiliency’ will be defined as the ability for a commercial building to withstand an interruption of its heating system during cold outdoor ambient conditions. Buildings with a fast rate of temperature degradation during heating system loss have low resiliency, while buildings with a slower rate of temperature degradation have high resiliency.

In extreme cold climates resiliency plays an integral role in protecting property during an outage. Drops in indoor temperature can pose a freezing risk to plumbing and wet sprinkler piping. Freezing pipes can lead to burst pipes and interior flooding. Pipe breaks due to freezing conditions are common in Alaska in both commercial and residential contexts. Flooding in commercial buildings can cause enormous damages that can be very expensive to repair. In addition, flooding can also lead to the loss of workspace, which affects productivity.

Therefore, it is necessary not only to look at building HVAC installations, but also on the building envelope and the whole energy infrastructure. A more resilient low carbon system (as compared to building-level steam boilers) can be achieved by taking advantage of the large thermal capacity of concrete and brick walls, and by using internal water pipes, critical system redundancy, a reasonable layer of outside insulation without weak points, and a centralized controlled hot water heat supply.

In addition to traditional cold climate building parameters, thermal resilience is a parameter of growing importance, especially for medical and university campuses, and military and government installations that house mission critical operations. Resilient energy systems (both electric and thermal) are those that can prepare for and adapt to changing conditions, and recover rapidly from disruptions including deliberate attacks, accidents, and naturally occurring threats (PPD-21 [White House 2013, HQDA 2015]). A quantitative approach described in Zhivov (2021a) allows for evaluation of both resilience metrics: the ability of a system to absorb the impact of a disruption (robustness) with minimal failure, and its ability to recover.

3.2 Energy system resilience metrics

For some critical missions where any amount of interruption from an event is unacceptable, it is assumed that power quality requirements and a short-term uninterruptible power supply to mission critical equipment is handled using building-level energy systems. Other critical missions can withstand small disruptions as long as the system can recover quickly. This can be quantified as a deviation in mission availability from baseline operations to the degraded system state following a

disturbance. A quantitative approach to resilience of energy system that supplies energy to the building can include (but is not limited to) the following metrics:

- Energy System Robustness
- Energy System Recovery time
- Energy Availability
- Energy Quality.

The first three parameters are critical for the selection of the energy supply system architecture and of the technologies that comprise the system, and to satisfy requirements related to energy system resilience. As described by Zhivov et al. (2021a), requirements to Energy Availability and Energy System Recovery Time depend on:

- Criticality of the mission being served by the system,
- System reparability, which has significant dependence on remoteness of the facility hosting the mission, and
- Redundancy of facilities that can serve the same critical function.

Energy Robustness requirements depend on the value of the mission critical load. Energy Robustness requirements can be (1) measured as the percentage of the load that is available to the mission in degraded state from the total mission essential load requirements (Figure 3-1), and (2) related to the overall building energy load under normal (blue sky) conditions.

Energy Quality is another important quantitative metric for the energy system serving critical functions and should be considered as a design parameter for internal building energy systems. Most mission-specific energy quality requirements can be handled by the building-level energy systems. Building-level electric systems (nano-grids) generally include redundant or backup components and infrastructure for power supply, UPS, automatic transfer switches, data communications connections, environmental controls (e.g., air-conditioning, fire suppression) and various security devices. These electrical systems can be designed to provide power with a severe demand on the stability and level of the frequency, voltage, and waveform characteristics of the uninterruptable electrical power to mission critical equipment and can operate in an islanded mode between 15 minutes and several hours.

For resilient thermal energy system planning, a well-insulated and airtight building envelope of a massive building can maintain habitable indoor air temperature for several hours after heat or cooling supply to the building is interrupted (see Chapters 4 and 8 for more details).

These internal electrical and thermal systems are designed based on class or tier of such facilities. Therefore, requirements to Energy Availability, Energy Recovery Time and Energy Quality to be specified for energy systems providing energy to the building will be different than those required by the critical equipment and personnel.

Energy Robustness is defined as “the ability to absorb shocks and continue operating” (NERC 2018). For many critical facilities, there may be many mission assets that are considered uninterruptible, critical but interruptible, and life and safety related. Since it is imperative to the mission that these assets remain online, any undelivered load to such facilities or assets would be considered mission failure; the shock has caused failure. Energy Robustness is a metric that shows the power availability, P (in kW and/or kBtu/hr) to satisfy critical mission loads over a period of time immediately following the event, measured as a fraction of the mission critical requirement or a fraction of the baseline energy requirement.

Using the Energy Robustness metric, we can quantify the overall resilience of a system in two phases: **absorption** of the event, and **recovery**. Consider an event occurring as shown in Figure 3-1. Immediately following the event, there is a sharp drop in the load available to mission. For electric energy systems, duration of phase one is much shorter than for thermal energy systems, unless thermal systems are used for processes using steam or hot water. This change from the baseline to the degraded state represents the robustness of the system to that particular event. The time required to restore the system to its baseline state is referred to as recovery. The smaller the change in load available to mission and the shorter the recovery time, the more robust the system.

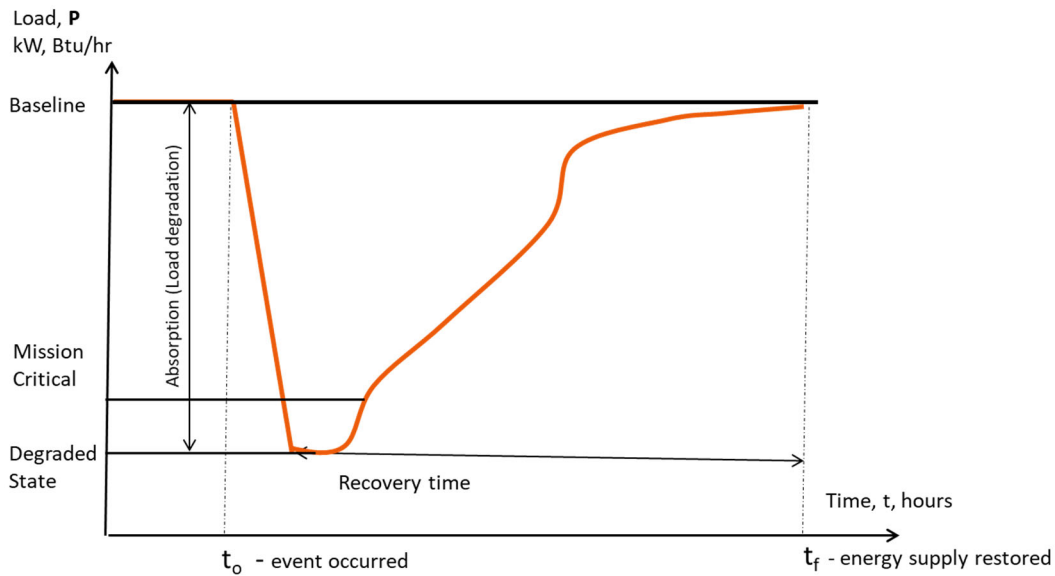

Figure 3-1. System Response to a disruptive event.

The robustness, R of the system to any particular event can be quantified using Equations 3-1 and 3-2. The smaller the area between the baseline and the curve, the more resilient the system. Robustness will be measured on the scale between 0 and 1, where 1 is the most resilient system:

$$R_{m.c.} = \frac{E_{event}}{E_{m.c.}} \quad (3-1)$$

$$R_{baseline} = \frac{E_{event}}{E_{baseline}} \quad (3-2)$$

where, $R_{m.c.}$ and $R_{baseline}$ are system robustness measured against the mission critical load and the baseline load; E_{event} , $E_{m.c.}$, and $E_{baseline}$ are energy supplied to the building during the period of time between t_0 and t_f with the baseline load, mission critical load and degraded due to event load and can be illustrated by the area between the line showing the baseline mission availability and the curve representing the actual mission performance over time:

$$E = \int_{t_0}^{t_f} P(t) dt \quad (3-3)$$

Depending on mission needs, it may be more important to prioritize either absorption or recovery. For example, Figure 3-2 shows two systems with different levels of absorption. The two systems have the same recovery time, but System 2 has a lower initial decrease in power available to the building.

System 2 is more resilient to the postulated event and is more robust than System 1 despite having the same recovery time.

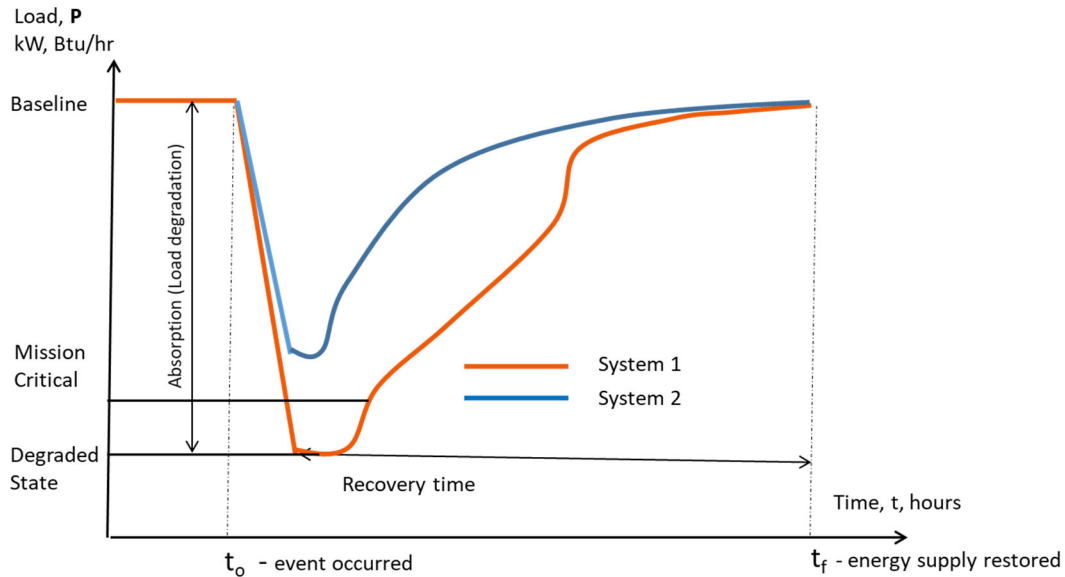

Figure 3-2. Two systems with different absorption.

In other cases, it may be more important to prioritize recovery from an event as opposed to absorption. Figure 3-3 shows two systems with similar absorption to an event, but different recovery times. Though both systems have the same ability to absorb the shock from the event, the shorter recovery time for System 2 yields a larger area under the curve. Accordingly, System 2 can be said to be more resilient than System 1.

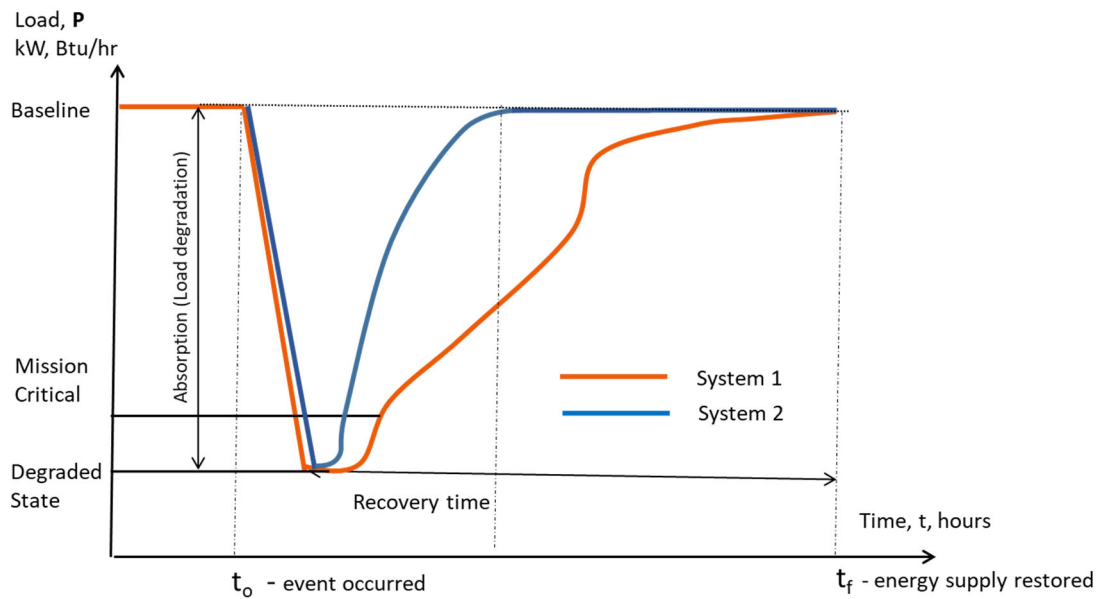

Figure 3-3. Two systems with different recovery time.

In the recovery phase, the system is stabilized, and no further damage or degradation is expected. The system may be operating in alternate or emergency modes with a reduced load. At the beginning of this

phase, energy may be provided to critical systems using internal building system with the power storage capacity followed by standby generators, emergency boilers, alternate utility feeds, or distributed energy resources. In this phase, the emphasis is on restoring the system to its baseline operation.

As previously discussed, the shorter the recovery time, the more robust the system. Recovery time is determined by the average length of time required to return damaged components to service. In general, the availability of energy for the mission increases as assets are recovered. For large or complex systems, availability during the recovery phase may change continuously. For smaller systems, or where fewer redundant paths exist, it can be more useful to consider the change in availability during the recovery phase as a step function. That is, there are discrete step changes in availability as components or success paths are returned to service.

Figure 3-4 provides an example of this concept for an electric energy system. In this example, an event has disabled both the onsite generation as well as one of two redundant utility feeders resulting in a significantly reduced power supply to the mission (degraded state). The onsite generators are quickly returned to service, resulting in a large step increase in availability to support mission critical loads. During generator unavailability, power to mission-critical assets is provided by UPSs integrated into the nano-grid. After some time, the redundant utility feed is returned to service, resulting in a second step increase in availability. It is important to note that for a single success path to be restored, all series components must be fully restored before improvements in availability are realized. For example, if an event disables a backup generator, its associated fuel tank and fuel lines, all of these assets must be repaired before that feed is considered back online.

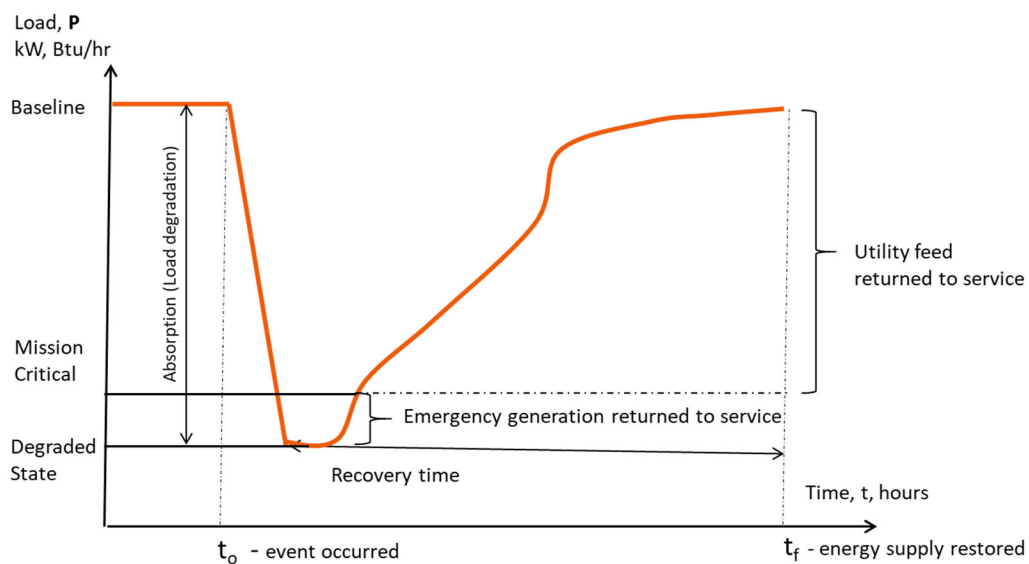

Figure 3-4. Stepped recovery of power system assets.

If one considers the step-change model illustrated in Figure 3-4, it becomes apparent that the recovery time for the system can be approximated using the mean time to repair (MTTR) for the various affected components. However, designers, planners, and facility managers must use caution when using MTTR to anticipate recovery time following a contingency event. MTTR data is typically based on failure modes that occur during normal operation. Contingency events may cause different failures to occur, and additional logistics delays must be considered based on the nature of the event

and the location of the site. To determine the recovery time for a system, MaxTTR data should be used as an input to an evaluation of the disaster recovery plan.

3.3 Maximum allowable downtime

Following a contingency event, the facility or site should have a plan in place to adapt to and recover quickly from its affects. Due to limitations of personnel, resources, and logistics, repairs for all components cannot occur simultaneously. It may also be required that some assets be restored in sequence. The priority should be given to restoring power to the level satisfying needs of mission critical loads. In this case, **MaxTTR** of the system providing mission critical load should be smaller than **maximum allowable downtime** assigned based on the configuration and a storage capacity of nano-grid.

While much discussion and research has focused on the resilience of electric energy systems, the resilience of thermal energy systems is especially important for extreme climate locations. Resilience requirements for a thermal system comprised of energy conversion, distribution, and storage components depends on the thermal parameters necessary for one or several of the following purposes:

- performance of required work in a building in a safe and efficient manner (habitability),
- support for processes housed in the building, and
- provision of conditions required for long-term “health” of the building itself (sustainability).

Maximum time to repair of thermal systems serving a building can be defined in terms of how long the process can be maintained or the building remains habitable or protected against damage to water pipes, sewer, fire suppression systems, sensitive content, or mold damage during extended loss of energy supply from extreme weather events. Analysis presented in Chapter 8 shows major factors affecting the time, when the internal temperature reaches the threshold of building habitability or sustainability include:

- difference between inside and outside air temperature;
- building envelope leakage rate;
- building envelope insulation properties, including insulation levels of its components, and thermal bridging;
- internal thermal load (people and appliances/equipment connected to electric power).

Also, thermal mass of building structures composed of concrete, masonry, or stone materials that constitute high levels of embodied energy enables the building to absorb and store heat to provide “inertia” against temperature fluctuation and allows an increase in time allowed for the thermal system to be repaired. Figure 3-5 shows how these factors will influence the time of building temperature degradation from the comfortable level (t_o) to the habitability (t_h) and sustainability (t_s) temperature thresholds.

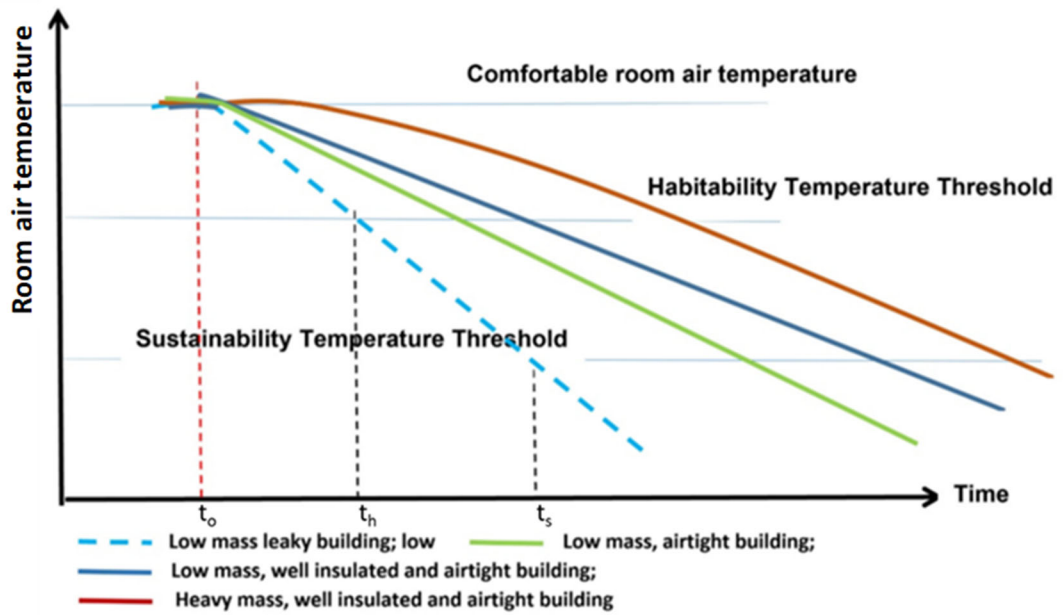

Figure 3-5. Notional example of temperature decay rate for different types of building envelope: comfortable level (t_o), habitability (t_h) and sustainability (t_s) temperature thresholds.

National requirements for building envelope characteristics, e.g., thermal insulation values of its components, building envelope air tightness, vapor permeability, building mass, detailing, etc., are usually based on economic and environmental considerations. Thermal energy system resilience consideration brings another dimension to the optimization process of these parameters.

CHAPTER 4. BUILDING ENVELOPE

Prescriptive guidelines for thermal insulation in the design of buildings in cold climates have traditionally been derived by a holistic consideration of climatic factors, energy policy, environmental policy, and economics. The differences in thermal barrier requirements in buildings across the Arctic and Subarctic regions of the world are as influenced by the differing priorities of the governing bodies that set these requirements as they are on actual physical demands and conditions. Usually, national requirements for building envelope characteristics such as thermal insulation values, building envelope airtightness, vapor permeability, building mass, and detailing are based on economics, durability, and environmental considerations. Consideration of thermal energy system resilience provides a new paradigm through which to view the optimization of these parameters.

This chapter summarizes best practice recommendations for the building envelope characteristics of buildings located in cold and arctic climates of the United States, Canada, and Scandinavian countries, and compares the effect of different levels of building envelope efficiency and mass on indoor air temperature decay when heat supply is interrupted.

4.1 Thermal insulation

Various methods for establishing minimum insulation values in buildings exist. The simplest guidelines are those that establish a single minimum insulation value for buildings by climate zone, differentiating only between the walls, roof, and floor, with additional guidelines for windows and doors (Tables 4-1 and 4-2). Changes to insulation requirements over time are less likely to be a result of a change in climate (e.g., more or less degree days per year over time) as they are to be as a result of a change in priorities associated with environmental, energy, comfort, economic, or societal parameters. As a general trend, guidelines for minimum insulation values have trended upwards, and continue to do so. This increase in insulation values impacts both new construction and retrofits.

Table 4-1. Window insulation standards.

Window Insulation Standards		Window Maximum U-Value Btu/(°F·ft ² ·hr) [W/(m ² ·K)]	Source
Country/ Region	Standard		
Alaska	Alaska Building Energy Efficiency Standard Climate Zone 7	0.30 [1.70]	Alaska Housing Finance Corporation 2018a,b
	Alaska Building Energy Efficiency Standard Climate Zone 8	0.22 [1.25]	Alaska Housing Finance Corporation, 2018a,b
	MILCON Initial Compliant Standards	0.33 [1.87]	Nygaard, 2019
Canada	Window Specifications for Cost Optimized Housing	0.17 [0.99]	RDH, 2016s, 2016b
	National Energy Code of Canada for Buildings (National Research Council Canada Climate Zone 7	0.33 [1.90]	National Research Council Canada, 2017
	National Energy Code of Canada for Buildings Climate Zone 8	0.25 [1.40]	National Research Council Canada, 2017
Finland	Decree of the Ministry of the Environment on the Energy Performance of New Building	0.18 [1.00]	Finnish Ministry of the Environment, 2017
Norway	Norwegian Regulations	0.21 [1.20]	Norwegian Building Authority. 2017
Greenland	Greenlandic Building Regulations	0.32 [1.80]	Greenlandic Building Regulations, 2006

Table 4-2. Insulation standards for cold regions.

Country/Climate Zone	Standard	Walls Minimum Insulation Value	Roof Minimum Insulation Value	Source
	Units	°F·ft ² ·hr/Btu [W/(m ² ·K)]	°F·ft ² ·hr/Btu [W/(m ² ·K)]	
Alaska	Deep Energy Retrofit Climate Zone 7	R-50 [U-0.11]	R-65 [0.09]	Zhivov and Lohse, 2020
	Deep Energy Retrofit Climate Zone 8	R-50 [U-0.11]	R-75 [0.08]	Zhivov and Lohse, 2020
	Alaska Building Energy Efficiency Standard Climate Zone 7	R-25 [U-0.23]	R-54 or 48* [0.11 or 0.13]	Alaska Housing Finance Corporation, 2018a,b
	Alaska Building Energy Efficiency Standard Climate Zone 8	R-30 [U-0.19]	R-59 or 48* [0.10 or 0.12]	Alaska Housing Finance Corporation, 2018a,b
	MILCON Initial Compliant Standards	R-45 [U-0.13]	R-60 [0.09]	Nygaard, 2019
Canada	Nunavut Good Building Practices	R-28 [U-0.20]	R-40 [0.14]	RDH, 2016a, 2016b
	Northwest Territories Good Building Practices	R-32 [U-0.18]	R-50 [0.11]	RDH, 2016a, 2016b
	Yellowknife – Existing Buildings	R-30 [U-0.19]	R-40 [0.14]	RDH, 2016a, 2016b
	Yukon Housing Corporation	R-28 Whitehorse R-21-9 Elsewhere [U-0.20 Whitehorse U-0.26 Elsewhere]	R-59 [U-0.10]	RDH, 2016a, 2016b
	General Passive House Guidelines	R-60 to R-80+ [U-0.09 to 0.07]	R-60 to R-100+ [U-0.09 to 0.06]	RDH, 2016a, 2016b
	National Energy Code of Canada for Buildings– Climate Zone 7	R-27 [U-0.210]	R-41 [U-0.138]	National Research Council Canada, 2017

Country/Climate Zone	Standard	Walls Minimum Insulation Value	Roof Minimum Insulation Value	Source
	Units	°F·ft ² ·hr/Btu [W/(m ² ·K)]	°F·ft ² ·hr/Btu [W/(m ² ·K)]	
	National Energy Code of Canada for Buildings– Climate Zone 8	R-31 [U-0.183]	R-47 [U-0.121]	National Research Council Canada, 2017
Finland	Decree of the Ministry of the Environment on the Energy Performance of New Building	R-35 [U-0.16]	R-65 [U-0.09]	Finnish Ministry of the Environment, 2017
Norway	Norwegian Regulations	R-26 [U-0.22]	R-32 [U-0.18]	Norwegian Building Authority, 2017
Greenland [^]	Greenlandic Building Regulations	R-28 for weight<100 kg/m ² or R-19 for weight>100 kg/m ² [U-0.20 for weight<100 kg/m ² or 0.30 for weight>100 kg/m ²]	R-38 (R-28 flat roofs) [U-0.15 (0.20 flat roofs)]	Greenlandic Building Regulations, 2006

* The smaller value may be used with a properly sized, raised-heel truss.
[^] Greenlandic codes offer three different ways in which to fulfill the building regulations: U-value, heat loss, or energy use.

The U.S. Federal government bases standards for thermal insulation in buildings on the Unified Facilities Criteria, which are in turn based on variations of the existing ASHRAE Standard 90.1-2019 (Table 4-3). This method of determining minimum insulation value considers the construction typology of the building as well as its size and cost, in an attempt to address economic and energy factors. Air Force projects use ASHRAE 90.1 as a standard while the other branches of the military use ASHRAE 189.1-2017, which represents a 10% nominal improvement over ASHRAE 90.1-2019. New construction projects over 10,000 sq ft (930 m²) and \$3M in cost are required to achieve a reduction in total building energy consumption of 30% over the ASHRAE 90.1-2019 baseline building.

Table 4-3. Climate Zone 8 thermal resistance requirements.

Standard	R-value (°F·ft ² ·hr/Btu) [U-value (W/(m ² ·K))]						
	Roof			Above-Grade Walls			
	Insulation Entirely above Deck	Metal Building	Attic	Mass (Concrete Masonry Unit [CMU])	Metal Building	Steel Framed (Metal Stud)	Wood Framed & Other (SIPS)
ASHRAE 90.1-2019	R-35.7 [U-0.16]	R-38.5 [U-0.15]	R-58.8 [U-0.10]	R-21.8 [U-0.26]	R-25.6 [U-0.22]	R-27.0 [U-0.21]	R-31.3 [U-0.18]
ASHRAE 90.1-2019 +30% Minimum* R-Value	R-46.4 [U-0.12]	R-50 [U-0.11]	R-76.5 [U-0.07]	R-27.1 [U-0.21]	R-33.3 [U-0.17]	R-35.1 [U-0.16]	R-40.6 [U-0.14]

Some regulatory entities employ a different approach to the thermal barrier of buildings in cold climates. Multiple methods are allowable to satisfy code requirements. In Greenland, for instance, there are three allowable methods to meet the regulations:

1. U-values for building components (only possible if the area of windows and doors does not exceed 22% of the heated floor area).

2. Maximum allowable heat loss from a given building.
3. Calculation of total energy use based on a method dictated by the building regulations and dependent on location (north or south of the Arctic Circle).

While various codes provide alternate compliance paths, typically pursuing energy modeling approaches, prescriptive thermal insulation values provide a good starting point for design. Excluding the highest and lowest outliers, the prescriptive values for insulation in Climate Zone 7 ranges between R-28 and R-45 ($^{\circ}\text{F}\cdot\text{ft}^2\cdot\text{hr}/\text{Btu}$) [$U = 0.18 - 0.12 \text{ W}/(\text{m}^2\cdot\text{K})$] in walls, between R-48 and R-60 ($^{\circ}\text{F}\cdot\text{ft}^2\cdot\text{hr}/\text{Btu}$) [$U = 0.12 - 0.10 \text{ W}/(\text{m}^2\cdot\text{K})$] in roofs and is approximately $0.30 \text{ Btu}/(^{\circ}\text{F}\cdot\text{ft}^2\cdot\text{hr})$ [$1.70 \text{ W}/(\text{m}^2\cdot\text{K})$] for windows. In Climate Zone 8, prescriptive values range between R-38 and R-50 ($^{\circ}\text{F}\cdot\text{ft}^2\cdot\text{hr}/\text{Btu}$) [$U = 0.15 - 0.11 \text{ W}/(\text{m}^2\cdot\text{K})$] for walls, between R-59 and R-75 ($^{\circ}\text{F}\cdot\text{ft}^2\cdot\text{hr}/\text{Btu}$) [$U = 0.10 - 0.08 \text{ W}/(\text{m}^2\cdot\text{K})$] for roofs, and $0.22 \text{ Btu}/(^{\circ}\text{F}\cdot\text{ft}^2\cdot\text{hr})$ [$1.25 \text{ W}/(\text{m}^2\cdot\text{K})$] for windows.

The range of prescriptive thermal insulation values described above considers energy guidelines, economic factors, and construction realities. It does not, however, address thermal resiliency. Thermal resilience as an input variable in the setting of insulation guidelines is a relatively new field that brings its own priorities. Specifically, the time to repair analysis (Liesen et al. 2021) of existing buildings will influence the range of advisable insulation values. The time to repair modeling of buildings of various construction typologies can add insight and focus to recommendations for overall thermal performance guidelines.

4.2 Thermal bridging metrics and mitigation

Thermal bridging occurs when highly conductive elements partially or fully penetrate the insulated building envelope. Common examples include studs, fasteners, shelf angles, exposed slab edges, and structural steel beams, but can also include geometric thermal bridges, and thermal bridges created at the transitions between envelope elements such as at window perimeters or roof-to-wall interfaces (Figure 4-1).

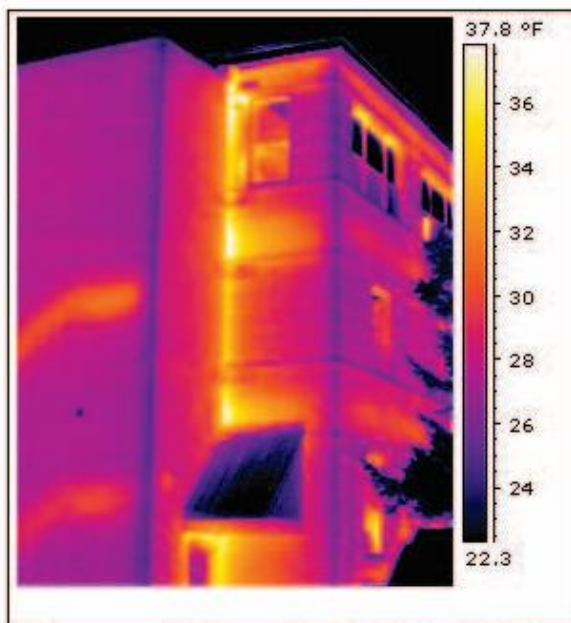

Figure 4-1. Infrared thermographic image of typical thermal bridge in cold climates.

While thermal transmittance (U-value) and thermal resistance (R-value) are most commonly used to quantify the thermal performance of assemblies, a set of additional metrics is required to quantify the impact of thermal bridging elements.

Point thermal bridges are typically described using a point thermal transmittance, or Chi-value (X , W/K or $Btu/[hr \cdot ^\circ F]$). An X value is the additional amount of heat flow through an assembly caused by a point thermal bridging detail such as a screw, clip, fastener, tie, etc. It is calculated by subtracting the heat flow through a building envelope assembly with no thermal bridge from the heat flow through the same assembly but including the point thermal bridge. In some cases, it can be more practical to include repetitive point thermal bridges such as fasteners and cladding attachment clips within the U-values or R-values so that they can be applied to an area of building envelope rather than counted individually.

Linear thermal bridges such as flashings, parapets, or window perimeter installation details are typically described using linear thermal transmittance, Psi-value (Ψ , $W/[m \cdot K]$ or $Btu/[ft \cdot hr \cdot ^\circ F]$). Similar to an X value, Ψ -values are calculated by subtracting the heat flow through an assembly (or pair of assemblies) with no thermal bridge from the heat flow through the same assembly but including the linear thermal bridge.

These thermal bridging metrics can be thought of as correction factors, which can be used to correct the clear field U-value or R-value such that it also accounts for thermal bridging. In addition to these metrics, which quantify the energy transfer characteristic of a thermal bridge, an additional metric is required to assess the risk of condensation or frost accumulation on a cold surface as a result of thermal bridging. Typically, either the surface temperature itself is used for this purpose, or temperature index (I) can be used as a metric independent of the boundary condition temperature.

Various standards exist for calculating these metrics and describing how they are aggregated for the purpose of energy calculations. While the building industry is generally familiar with large thermal bridges such as parapets, balconies, and intermediate floors, one thermal bridge that has largely been neglected is the window-to-wall interface. Conventional window frames and the associated detailing are often one of the worst thermally performing elements of a building, from both an energy and an interior surface temperature perspective. While window selection has a significant impact, the installation detailing can significantly impact window performance. Optimizing the window placement within the rough-opening and over-insulating the window frames on the exterior are two strategies that can effectively reduce the thermal bridging typically associated with window-to-wall interfaces.

4.3 Vapor diffusion

Insulated building assemblies often require vapor diffusion resistance protection to reduce the risk of elevated humidity levels and condensation within interstitial spaces, which can lead to mold growth, decay, and corrosion. However, the vapor-retarding properties of materials that are typically used to provide this protection also prevent the assembly from drying out in response to incidental wetting that may occur from other, more significant, sources of moisture such as air leakage and water intrusion. In cold climates, where indoor-to-outdoor vapor pressure differences are typically significant, it is common to use exterior insulation to reduce thermal bridging and increase the temperature of moisture sensitive elements such as the building structure and sheathing. In some cases, relatively impermeable insulations are used in these arrangements, such as extruded polystyrene, while in other situations semi-permeable or permeable insulations such as expanded

polystyrene or mineral wool are used. Additional insulation at the inside of the structure is typically vapor permeable, such as fiberglass, mineral wool, or cellulose, although other options do exist such as closed-cell polyurethane spray foam.

Hygrothermal modeling was completed to assess the vapor diffusion related performance of generic split-insulated wall assembly arrangements (refer to section 4.5.2) potentially appropriate for use in cold climates. In this modeling, the critical material layer was plywood/oriented strand board (OSB). These products are considered sensitive to mold growth and serve critical structural functions. Many buildings may have structural layers of metal or masonry, which would have different mold growth characteristics due to less sensitive nature of these substrates. Under undesirable conditions, frost, condensation, or corrosion may appear on masonry or metal surfaces, and mold growth can also occur on dirt/dust accumulated on the surface of these materials. Moderate amounts of frost will melt in warmer periods, and either be absorbed within the materials (to dry later) or puddle at the base of the assembly. These effects are not included in this analysis. The strategies presented here to reduce mold growth on wood substrates are likely also to be effective at reducing the likelihood of frost accumulation at a surface; however, the difference in vapor permeability of these alternate substrates should be considered.

With Humidity Class 2 taken as the interior humidity (25 – 35% wintertime relative humidity, depending on climate, as described in Chapter 5), no interior vapor control membrane (i.e., polyethylene sheet) included, and with mold-sensitive materials such as plywood in the structure, hygrothermal modeling has found that:

- In Climate Zone 6, vapor diffusion alone will not cause problems if at least 20% of the total insulation thermal resistance is installed to the exterior of the wood sheathing
- In Climate Zone 7, vapor diffusion alone will not cause problems if at least 33% of the total insulation thermal resistance is installed to the exterior of the wood sheathing
- In Climate Zone 8, vapor diffusion alone will not cause problems if at least 50% of the total insulation thermal resistance is installed to the exterior of the wood sheathing.

The modeled hybrid walls contain no interior membrane (polyethylene) vapor barriers, so they have maximum drying potential from the building cavity toward the indoors.

It is important to note that, while these hygrothermal models focus specifically on the subject of diffusion, they do not consider a complete view of envelope design as it relates to longevity and resilience. It is known that from the standpoint of mold growth and other concerns, the ratios modeled above may be insufficient in real-world cases in cold and arctic climates, largely as a result of alternate, and often more substantial, wetting mechanisms such as exfiltration. For this reason, in actual practice the proportion of exterior insulation would likely need to either be higher than the models predict, or if that is not economical or practical, the wall should use permeable insulation on the exterior. More permeable exterior insulation and sheathing membranes in conjunction with an interior vapor control membrane will also work to improve the overall durability of these wall assemblies with respect to the potential for interstitial condensation and subsequent related damage. Hygrothermal modeling, including consideration of air leakage and incidental wetting, should be completed if a split-insulated wall system is to be used. This analysis is especially critical for humidified buildings and should be used to determine the amount of interior insulation that can be safely used without creating moisture damage risks.

In summary, most moisture damage to building assemblies occurs from water leaks, or from air leaks carrying humid air. Prevention of these forms of damage hinges on good management—by design, construction and operation—of water and air. Thermal insulation choices are made based on code and project requirements. Vapor control measures (described above) are implemented to control the relatively small amounts of moisture associated with vapor diffusion. Thermal insulation measures and vapor control measures should not be considered as appropriate for preventing or resolving water leakage or air leakage problems.

4.4 Airtightness

Airtightness of the building envelope assists in providing various important building functions. The control of exfiltration to reduce the risk of interstitial condensation, and the control of infiltration to reduce building energy consumption, are typically of the highest importance, and are of particular importance in cold climates. Airtightness can also impact thermal comfort, indoor air quality, resistance to chemical attack, acoustic separation, and mechanical ventilation performance. Of increasingly noted importance is also the contribution of airtightness to thermal resiliency.

Historically the building industry has taken a component approach to airtightness, typically specifying the airtightness of individual materials, systems, or products that form part of the building air barrier systems. It is now well recognized that while the airtightness of these elements is important, this alone is not sufficient to ensure that an airtight building envelope is achieved. This is because critical air leakage locations are typically found at the interfaces between these elements and are highly dependent on design coordination and quality control through the construction process. As a result, more modern codes and standards have developed a preference for whole-building airtightness testing as a quality assurance measure to evaluate the adequacy of the installed air barrier system.

Airtightness testing of large buildings in cold climate regions has been used for research purposes since the early 1970s in Canada by the National Research Council, and later in the mid-1980s in the United States by the National Bureau of Standards, and in Great Britain by the Building Services Research and Information Association (Potter 1998). Since then, airtightness testing, called air permeability testing in Europe, has developed into a robust building envelope commissioning industry and is used in conjunction with other commissioning tools to verify airtightness of the building envelope components and assemblies.

Whole-building airtightness testing is a great way to determine the building's air leakage rate and, by extension, thermal resiliency. However, air leakage testing only reveals the air barrier's overall performance, so individual air leaks that can cause localized moisture damage can still be present in a building that receives very good airtightness test results. Therefore, airtightness testing should be used as only one part of a comprehensive Quality Control/Quality Assurance program, which also includes air barrier design review, air barrier inspections, and infrared thermography.

Air barrier design reviews should be performed to ensure that the construction documents are complete and correct regarding the construction of a continuous air barrier across the entirety of the building envelope. Missing, incomplete, incorrect, or un-constructible air barrier details are very common, and lead to poor air barrier installations. Air barrier inspections should occur during construction to ensure that proper materials and installation techniques are being used, and they should follow Air Barrier Association of America (ABAA) guidelines. They should include the

observation and testing of a significant sample of details that cover the typical weaknesses in the air barrier, including all transitions in geometry and materials. Finally, infrared thermography should be used to locate and qualitatively ascertain the magnitude of air leaks. While it is not possible to have a perfect air barrier, a high-performance air barrier (necessary for thermal resiliency) is very much possible with proper design and construction quality control measures.

Since 2009, the U.S. Army Corps of Engineers (USACE) has implemented an airtightness requirement in all new construction and building envelope renovation projects. Engineering and Construction Bulletin (ECB) 2012-16 (HQUSACE 2012) set levels of airtightness for building envelopes at the material, assembly, and system-level having a maximum air leakage of 0.25 cfm/sq ft at 75 Pa ($3.5 \text{ m}^3/\text{h}/\text{m}^2$ at 50 Pa) for the six-sided building envelope (Zhivov et al. 2014). This airtightness requirement is comparable to England's H.M. Government Non-Dwelling Building Code Regulation, 2010-16 L2a, which currently requires 0.21 cfm/sq ft at 75 Pa ($3.0 \text{ m}^3/\text{h}/\text{m}^2$ at 50 Pa). The U.S. Army Corps of Engineers (USACE) ECB 2012-16 references many American Society for Testing and Materials (ASTM), International Organization for Standardization (ISO), and other related publications as the basis for how USACE projects are to use air leakage testing and thermal imaging for building envelope commissioning requirements. The implementation of these building envelope airtightness requirements over the past several decades for Department of Defense projects has drastically improved the level of understanding, design considerations, and construction methods of air barriers in the United States. Improvements in design, air barrier products, and installation practices have occurred during each construction cycle since 2009, resulting in a progressive learning curve for all parties involved (Leffel 2021).

Zhivov et al. (2014) reported that the average for the first 200 USACE building envelope tests was as low as 0.17 cfm/sq ft at 75 Pa ($2.38 \text{ m}^3/\text{h}/\text{m}^2$ at 50 Pa). Modeled energy savings in the arctic climates indicate that upwards of 40-45% energy savings are possible with an airtightness requirement of 0.15 cfm/sq ft at 75 Pa ($2.10 \text{ m}^3/\text{h}/\text{m}^2$ at 50 Pa) (Figure 4-2). The next benchmark in meeting stringent national fossil fuel and GHG goals for Arctic and Subarctic regions will need to include more airtight building envelopes.

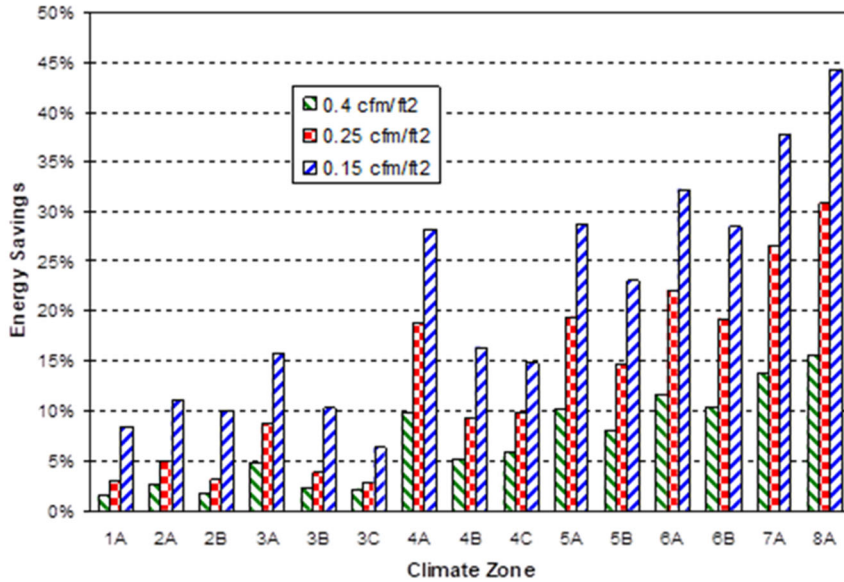

Figure 4-2. Percent annual energy savings in a barracks building due to air tightness improvement for U.S. climate zones. Source: Zhivov et al. (2014).

Review of test results conducted in Alaska (Leffel 2021) shows examples of projects with air leakage results at or below 0.25 cfm/sq ft at 75 Pa ($3.5 \text{ m}^3/\text{h}/\text{m}^2$ at 50 Pa) that had significant air leakage pathways uniformly at major air barrier joints. Figure 4-3 shows thermal images of a building that tested at 0.25 cfm/sq ft at 75 Pa ($3.5 \text{ m}^3/\text{h}/\text{m}^2$ at 50 Pa), which still experiences significant air leakage signatures at the roof-to-rake wall joints. By comparison, infrared thermography has shown that projects with buildings tested to be below 0.15 cfm/sq ft at 75 Pa ($2.1 \text{ m}^3/\text{h}/\text{m}^2$ at 50 Pa) had substantially fewer air leakage pathways at major air barrier joints.

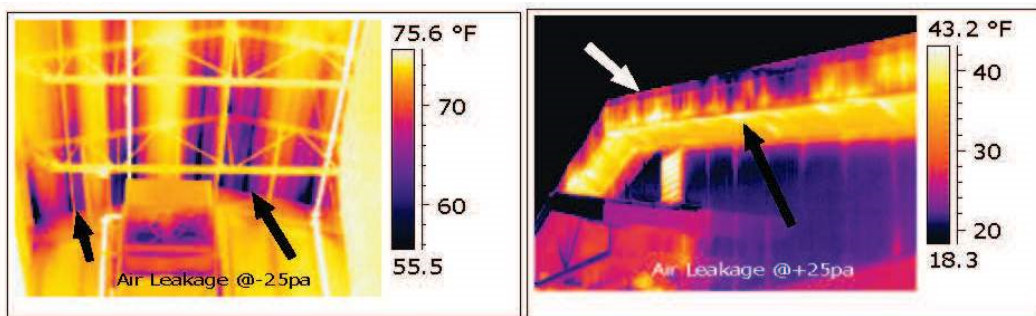

Figure 4-3. IR Images of air leakage at roof-to-rake wall joints; ALT results = 0.25 cfm/sq ft at 75 Pa ($3.5 \text{ m}^3/\text{h}/\text{m}^2$ at 50 Pa). Source: Leffel (2021).

Building durability, indoor air quality, energy savings, and thermal resilience justify the need for more airtight building envelopes in cold climate regions. By far the most damaging mechanism of moisture deposition in walls in cold climates is through air leakage (ASHRAE 2021). Average published test results in combination with airtightness levels shown to be achievable in building envelope airtightness testing around the world outline a missed opportunity in building airtightness. For these reasons, it is recommended that airtightness requirements for cold climate regions be increased to 0.15 cfm/sq ft at 75 Pa ($2.10 \text{ m}^3/\text{h}/\text{m}^2$ at 50 Pa) for normal indoor wintertime relative humidity

conditions, and 0.10 cfm/sq ft at 75 Pa (1.41 m³/h/m² at 50 Pa) for buildings humidified to 30% relative humidity or higher.

4.5 Wall and roof assemblies

The building envelope is a system of materials, components, and assemblies that physically separates the exterior and interior environments. It comprises various elements including roofs, above-grade walls, windows, doors, skylights, below-grade walls, and floors, which in combination must control water, air, heat, water vapor, fire, smoke, and sound. Additionally, the building envelope is an aesthetic element of the building. Each of these functions must be included in the design of the building envelope assemblies and components.

4.5.1 Roofs

For cold climates, an exterior-insulated roof is recommended. Typically, this is provided in the form of a conventional roof assembly, with slope to drains provided by a tapered insulation package or by the structure itself. A key consideration for these assemblies is to reduce thermal bridging as much as possible; consequently, a fully adhered system is typically recommended over a mechanically fastened system. Membrane compatibility with extreme cold should also be considered, as some roofing membranes (such as TPO and PVC) are known to fail in extreme cold temperatures. Airtightness and vapor control in this assembly are both provided by a membrane installed on the roof deck. This assembly is suitable for all types of building structural systems. Illustrations of common approaches to this assembly are shown in Figure 4-4. An alternate approach is to use a protected membrane assembly, which has the benefit of protecting the membrane from extreme exterior environmental conditions.

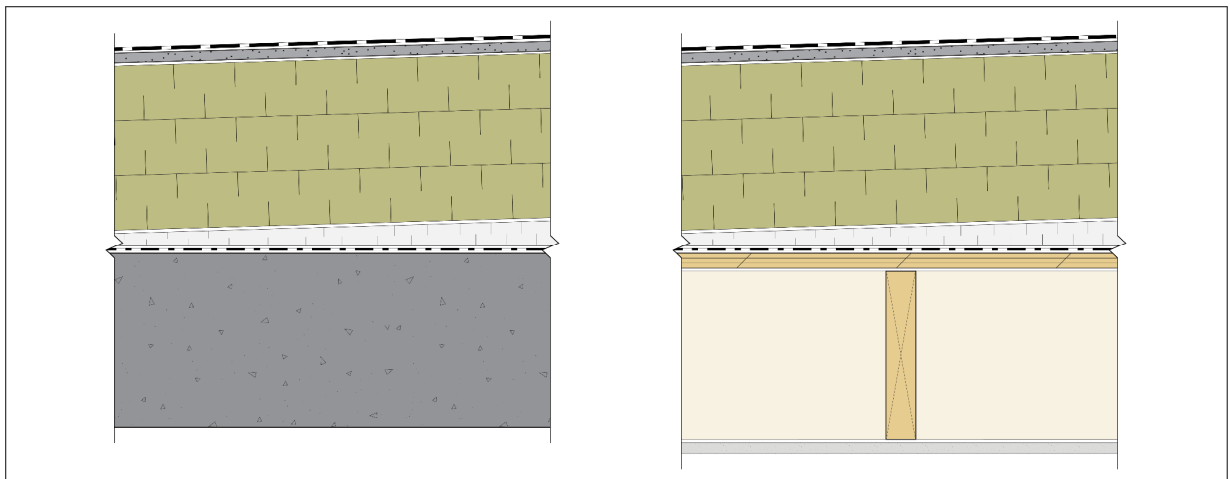

Figure 4-4. Conventional roof assembly on a concrete structure (left) and on a wood structure (right). From exterior (top) to interior (bottom) these assemblies include roof membrane, cover board, insulation, tapered insulation, air and vapor control membrane, and structure.

Sloped roofs should pursue similar exterior-insulated strategies to reduce thermal bridging through the assemblies, and often techniques described in Section 4.5.2 with respect to walls, are also generally applicable to sloped roofs. Due to high snow loads and potential concerns with thermal bridging from continuous fastener cladding attachment techniques, it can often be practical to

introduce a plywood or OSB shear layer within the insulation thickness to allow for increased strength and shorter offset fasteners.

4.5.2 Walls

For cold climates, an exterior-insulated wall assembly is recommended. A key consideration for these assemblies is the support of the exterior finish (i.e., cladding). In some cases, this can be incorporated as part of insulation products (i.e., exterior-insulated finish system [EIFS] or insulated metal panel [IMP]) and in others, specific cladding support designs will need to be considered, such as thermally broken cladding attachment clips or long fasteners through the insulation.

Airtightness in this assembly can be achieved using a membrane applied to the sheathing. This membrane can be relatively impermeable to control vapor diffusion. In systems with cladding independent of the insulation, a drained and vented cavity should be provided behind the cladding. In alternate systems, similar provisions should be provided as appropriate, including at joints in panel type systems. This assembly is suitable for all types of building structural systems. Figure 4-5 shows a common approach for this assembly.

Sometimes due to economic or structural constraints, a split-insulated wall is recommended to make efficient use of the cavity space created by the wall structure. This approach can be particularly beneficial when using structural systems with relatively low thermal conductivity (i.e., wood), where the insulation effectiveness is better realized. Similar to the exterior-insulated wall described above, a variety of insulation and cladding attachment strategies are available. For wood construction, long fasteners through insulation are more common and constructability of this approach can be improved through the use of $\frac{3}{4}$ -in. (19 mm) sheathing. Figure 4-6 shows a common approach for this assembly.

While interior air barrier systems are possible with a split-insulated assembly, for best practice air leakage control, an exterior air barrier system such as sealed sheathing or a sheathing membrane is recommended. This layer would typically also be the primary water control layer. Depending on the split between interior and exterior insulation, and the vapor permeance of the insulation, vapor control should be provided on the interior, often by a polyethylene sheet.

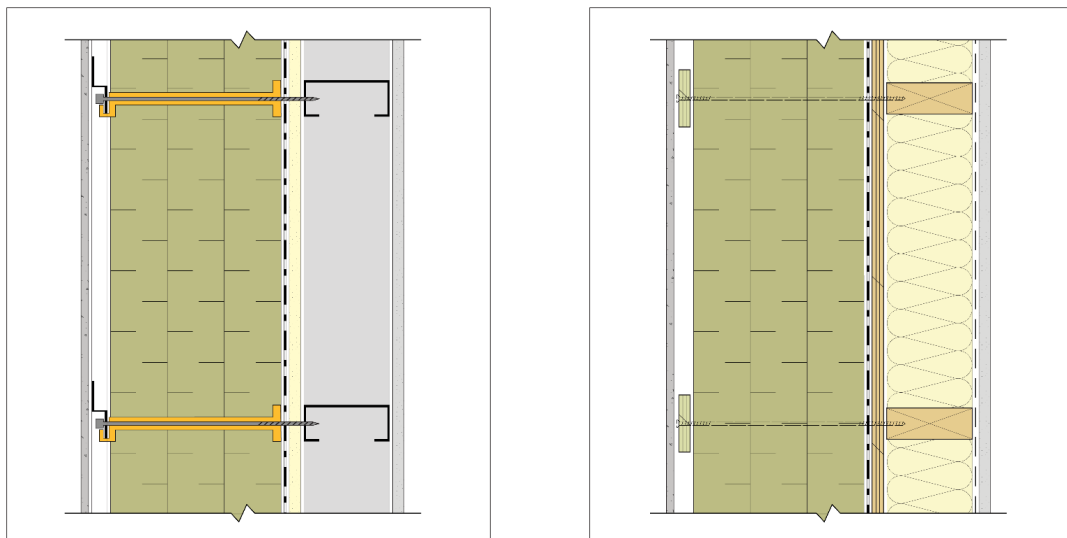

Figure 4-5. Exterior-insulated steel stud wall assembly, and similar approaches are appropriate for other backup wall structures including wood and CMU. From exterior (left) to interior (right), this assembly consists of cladding, continuous girts exterior of the insulation to receive cladding fasteners, thermally efficient intermittent cladding attachment clips fastened to structure, air/water/vapor control membrane on the sheathing, exterior grade gypsum sheathing, structure (steel studs), and interior finish.

Figure 4-6. Split-insulated wood stud wall assembly. From exterior (left) to interior (right), this assembly consists of cladding, wood furring attached with long fasteners, exterior insulation, air/water control membrane on the sheathing, wood sheathing, wood studs with insulation, interior vapor barrier membrane, and interior finish.

4.5.3 Fenestration

Selection of a fenestration system for cold climates is of particular importance as this is typically the lowest performing element of the building envelope from the perspective of thermal control, and thus the most likely cause of energy, comfort, and durability challenges. Key performance considerations include structural capacity, water penetration resistance, airtightness, thermal conductance (U-value), solar heat gain coefficient (SHGC), visible light transmission (VLT), and temperature index (I). There are two primary components of any fenestration system that must be considered: the frame and the glazing.

4.5.3.1 Frame

The frame of a window significantly impacts the window's thermal performance and is the most common location for condensation or frost accumulation issues. Additionally, the air and water tightness of the frame and associated dry (i.e., gasket) and wet (i.e., sealant) seal components is fundamental to the fenestration product's overall performance.

All window materials are potentially applicable to cold climates; however, care must be taken when using thermally conductive base materials such as aluminum to achieve other design objectives, to also ensure that a well thermally broken product is selected. While high performing aluminum products exist, many products typically used in warmer climates are not likely to be appropriate for cold climates.

Other frame considerations include the durability of finishes, internal water control strategy (pressure moderated and drained strategies recommended), hardware type and durability (i.e., multi-point locking hardware improves compression on air seal gaskets for operable units), and integration with the surrounding building envelope. Many high-performance installation details call for exterior insulating the frame, and this should be considered in the design of the frame, including operable vents (Zhivov et al. 2020).

Figure 4-7 shows some example illustrations of different window frame technologies appropriate for use in cold climates.

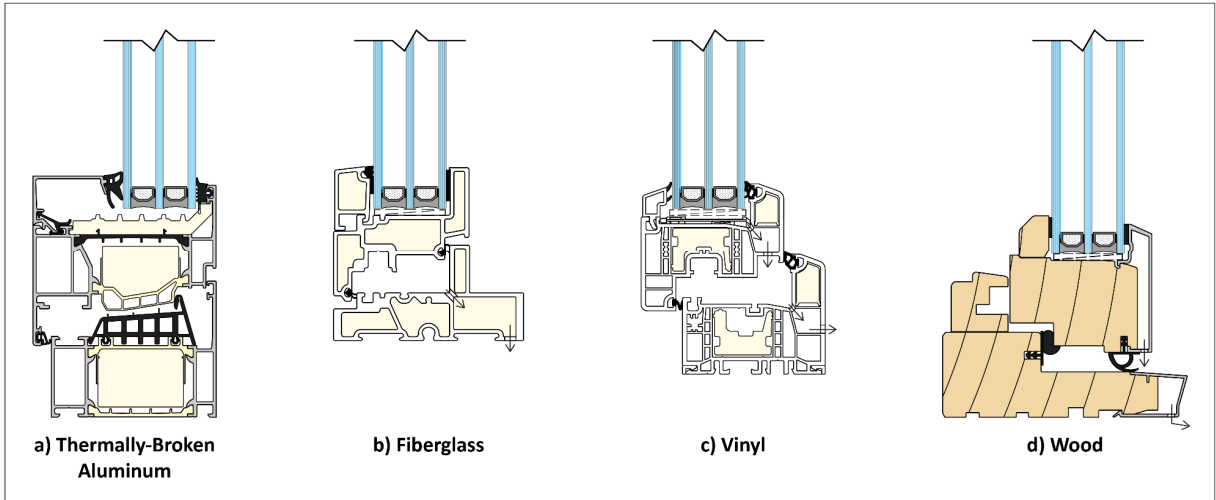

Figure 4-7. Illustration of high-thermal performance window frame types.

4.5.3.2 Glazing

In cold climates, a minimum of triple glazing is recommended (Alaska Housing Finance Corporation 2018a,b, Nygaard 2019, RDH, 2016a,b, National Research Council Canada 2017, Finnish Ministry of the Environment 2017, Norwegian Building Authority 2017, Zhivov and Lohse 2020) in conjunction with a combination of low emissivity coatings and gas fills to optimize thermal conductance, solar heat gain, visible light transmission (VLT), and interior surface temperatures. Technologies such as suspended films, electrochromic glazing, and vacuum insulated glazing are less common, but with appropriate due diligence, may also be suitable for some applications.

Spacer bar systems should be selected to reduce thermal bridging. Dual seal stainless steel, silicone, and thermally broken spacer bars often perform well from this perspective. In all cases, the durable long-term performance of the insulated glazing units is essential. Insulated glazing units designed and tested in accordance with applicable standards such as (ASTM 2019) are recommended.

4.6 Pertinent details

The continuity of the building envelope control layers described in the preceding sections (air, thermal, water, and vapor diffusion) is critical to the performance of the building envelope and is heavily dependent on proper detailing. Each transition in plane or material represents an opportunity for the building envelope to be improperly installed, discontinuous, or naturally vulnerable to damage. The continuity of the air and thermal barriers are especially critical to support the building's thermal resiliency in cold/arctic climates, as has been demonstrated in previous sections. Localized areas of air leakage or thermal bridging can cause significant heat loss and interstitial condensation, which can impact indoor air quality, increase energy consumption, and lead to damage in form of mold, decay, or corrosion. This section highlights a few of the most important details of a high-performance building envelope in support of thermal resiliency in cold/arctic climates.

4.6.1 Structural support of exterior finishes

The extreme thickness of exterior insulation in cold/arctic climates typically requires structural supports for exterior finishes, which introduce another layer of potential thermal bridging. Several strategies exist to minimize the resulting thermal and moisture impacts. Adhesive-based systems, such as EIFS and fully adhered membrane roofs avoid highly conductive structural supports or fasteners and reduce thermal bridging. Depending on wind loads, cladding weight, and insulation thickness, exterior wall finishes can often be supported by mechanical fasteners alone as shown in Figure 4-8a). Each fastener acts as a thermal bridge, reducing the wall's thermal resistance, but the relatively small percentage of area covered by fasteners makes this a better option than structural support members that penetrate the insulation plane. For exterior-insulated sloped roof systems, partial-depth mechanical fasteners can transfer structural loads through a plywood layer embedded within the large insulation layer, while avoiding direct transfer of thermal loads between the interior and exterior spaces.

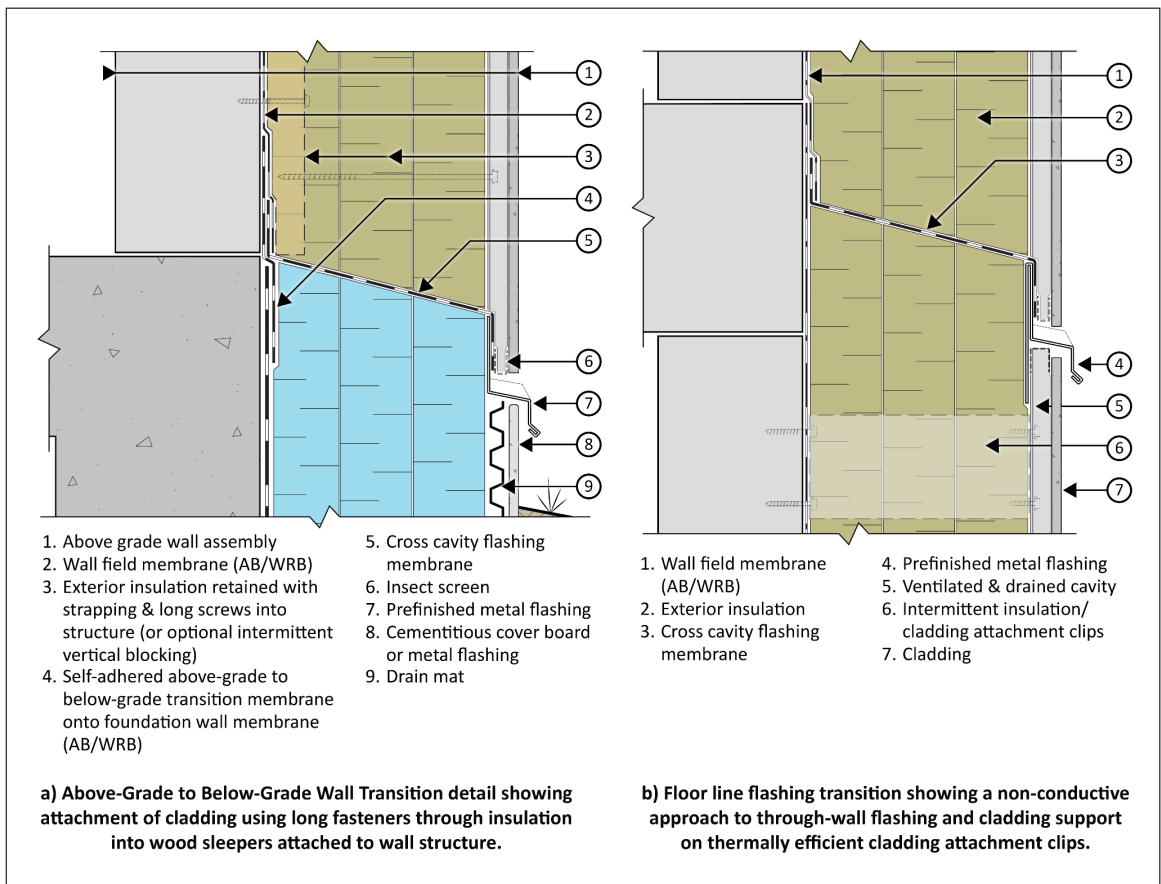

Figure 4-8. Schematic floor line details for exterior-insulated wall assemblies.

When the fastener-only approach is not feasible for wall cladding support, then metal furring can be supported by low-conductivity (fiberglass) and/or thermally broken clips that penetrate the insulation layer as shown in Figure 4-8b). While these proprietary systems perform well, they often do not survive value engineering efforts.

Another option that does not perform as well, but that often fits within project budgets and can be used with greater insulation depths, is a two-layer furring system. Ideally, the two layers of furring

would be oriented at 90 degrees from each other, so direct thermal bridging is limited only to the small areas of contact between the furring members. While orienting the two layers perpendicular to each other does reduce the thermal bridging created by these steel elements, typically this approach is on the order of 30% to 40% less effective than thermally efficient clips or long fasteners. Whenever possible, the first layer of furring should be lumber, which helps to reduce this thermal bridging effect due to its lower thermal conductivity.

4.6.2 Window openings

Window openings present several challenges to control layer continuity. In addition to properly draining the wall above the window, and flashing the sill to prevent water intrusion, the air barrier must connect the wall to the window, to prevent leakage through the shim space. Full-depth injection of low-expansion foam and a bead of sealant around the entire perimeter of the window frame is used to prevent interior air from escaping and causing condensation in this relatively weaker portion of the building's thermal barrier (Figure 4-9). The water-resistive barrier (often doubling as an air barrier) must maintain its shingle-lapped installation sequence across the opening, and rainscreen furring should be intentionally gapped to allow for ventilation air to flow around horizontal furring at the windowsill. Figure 4-9 shows a schematic windowsill detail.

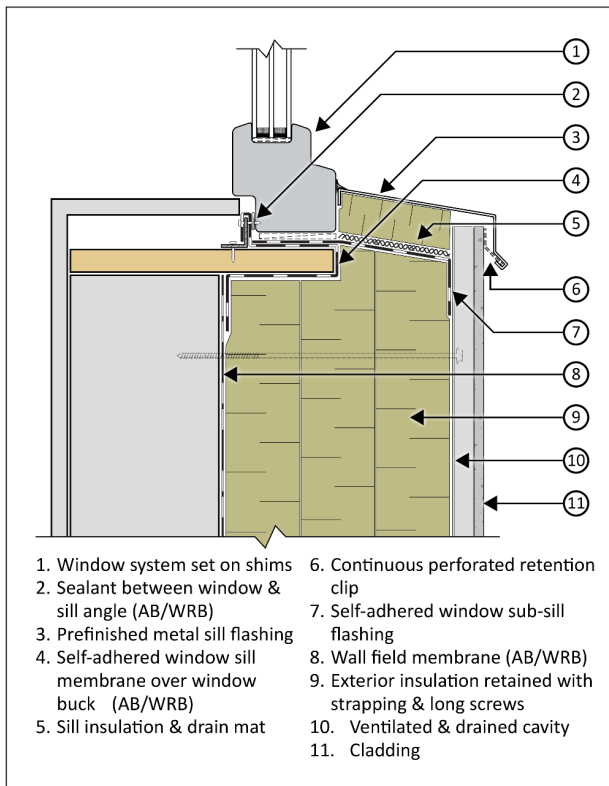

Figure 4-9. Schematic windowsill detail showing key design elements for high-performance detailing. In particular, this detail includes a membrane upturn on a back-dam angle for enhanced water penetration resistance, continuity of the air barrier from the wall system to the window product, over-insulation of the window frame to reduce thermal bridging, and sub-sill drainage to direct any water that penetrates to the sub-sill area out to the exterior of the wall assembly.

4.6.3 Penetrations

Mechanical and electrical penetrations through building envelope surfaces are common locations for air leakage and water penetration, and as such, require proper detailing. The cavity around all penetrations should be fully insulated with injection foam to make sure that the full depth of the space is filled. In particular, drain box cavities (for roof drains) are large voids that need to be insulated in the same fashion as the rest of the roof. The penetrating member itself can also be a good conductor of heat (thermal bridge), causing condensation to form on the interior side of the penetration. In arctic climates, pipe lagging with vapor retardant coating should be installed on the first 10 ft (3 m) of the pipe on the inside of the building.

4.6.4 Wall-to-roof transitions

As discussed in previous sections, the wall-to-roof transitions typically represent the largest source of air leakage and can present opportunities for thermal bridging if not properly detailed. This area of the building envelope involves transitions in materials, geometry, and often subcontractors, so there is often confusion over responsibility and sequencing between the different trades. Maintaining continuity of the thermal insulation and air barrier at this transition is paramount to the performance of the building envelope.

For low-slope roofs, the parapet framing must be completely surrounded by exterior insulation on all three sides to avoid thermal bridging. The wall air barrier must be sealed to the roof air barrier, but this connection can be challenging to construct, especially if the wall air barrier is on the interior side of the wall. When exterior air barriers are used, the interior air that is in the parapet framing space is in a narrow “cold peninsula” surrounded by cold wall construction on three sides. Relatively high humidity air from the interior may form condensation on cold surfaces within this space if it falls below the dew point temperature of the interior air. To avoid this, it is sometimes prudent to provide an air seal at the interior of these “cold peninsulas.” Closed-cell spray foam or a pre-stripped membrane can be used to provide this air seal. The most appropriate air-sealing strategy depends on a number of factors, including the structural design, length of parapet or overhang projection, and the adjacent assemblies. Figure 4-10a) provides a schematic detail for a low-slope roof-to-wall transition detail at a parapet.

Similar considerations need to be applied to rake and eave details for exterior-insulated sloped roofs, ensuring both air barrier and thermal continuity. A schematic detail for a standing seam metal roof rake is provided in Figure 4-10b), and a sloped wood-frame roof-to-wall transition (i.e., eave) detail is provided in Figure 4-10c).

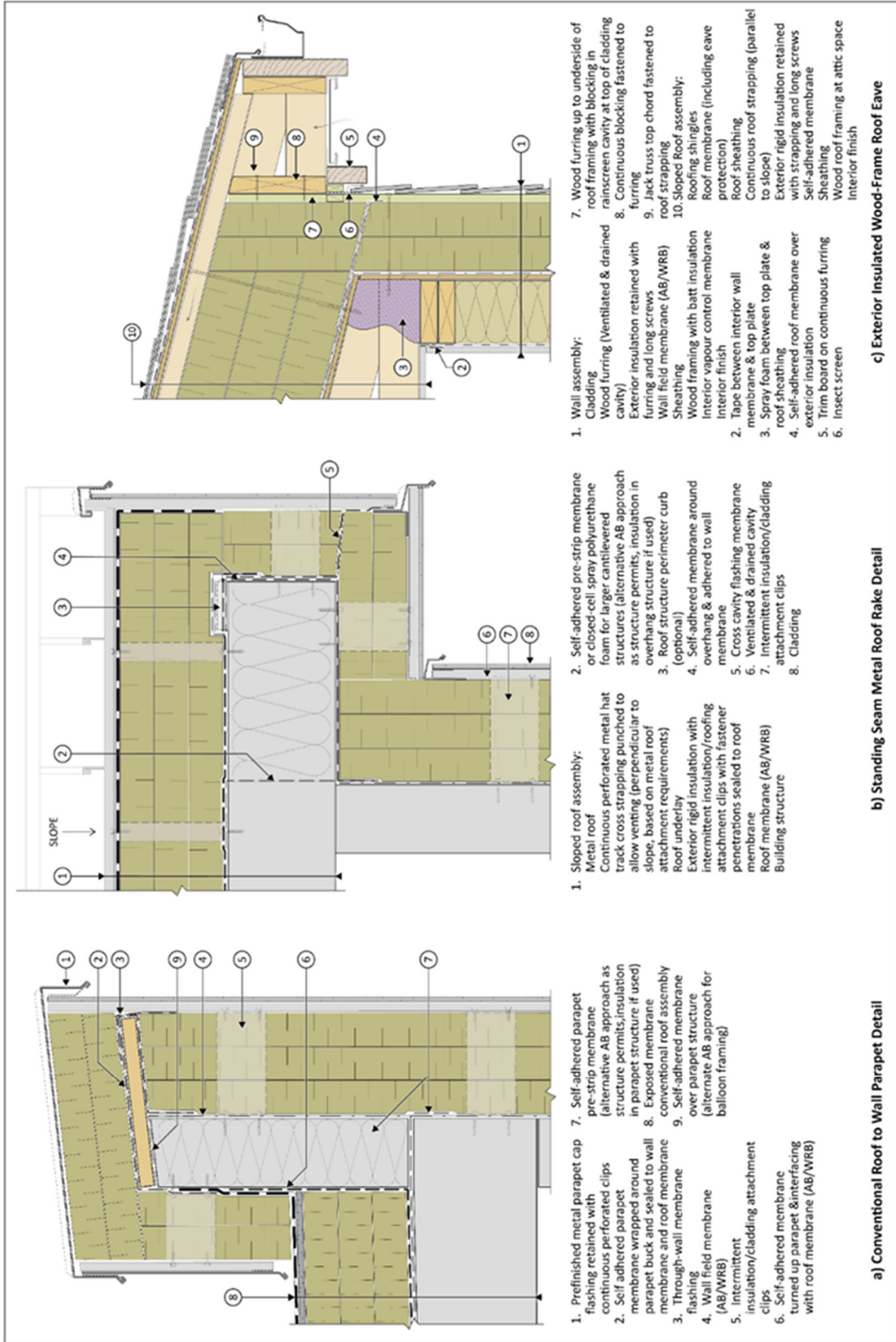

Figure 4-10. Schematic roof-to-wall details showing key design elements for high-performance detailing. In particular, note the continuity of control layers including the air barrier systems and the insulation in each of the details.

4.7 Recommendations

Increased thermal insulation, improved thermal bridge detailing, and whole-building airtightness have significant potential to impact the thermal resiliency of buildings in cold climates. In a study of the effect of different levels of building envelope energy efficiency (e.g., thermal insulation, air tightness) and mass, an indoor air temperature decay study was conducted to simulate interruption of the mechanical heating supply during outside temperature conditions of -40 °F (-40 °C) (Liesen et al. 2021). This study found that a building with a mass structure (concrete masonry unit [CMU], poured slab) and a less energy efficient building envelope design, the indoor air temperature approached the habitability level of 60 °F (16 °C) 9 hours faster than for a similar building with a more energy efficient building envelope, and 3 hours faster for the similar arrangements with a framed (i.e., lower thermal mass) building structure (Zhivov et al. 2021a). Intersection of the indoor air temperature decay line with the building sustainability threshold of 40 °F (4 °C) occurs 27 and 10 hours faster, respectively, for the same scenarios. When mass high-performance buildings are compared to buildings built using pre-1980 code standards (which constitute the majority of existing buildings), the difference in MaxTTR calculated till the building air temperature reaches habitability and sustainability threshold values, the difference in MaxTTR is much more significant. These results are shown in Figure 4-11a and 4-11b) and parameters associated with the different buildings as well as corresponding results are listed in Table 4-4.

Based on these findings, it is evident that a more energy efficient building envelope and a higher thermal mass structure improves thermal resiliency, such that under conditions with an exterior temperature of -40 °F (-40 °C), the building has approximately 8 more hours to reach habitability threshold and 26 more hours to reach sustainability threshold, during which time the heating system can be repaired. Therefore, more thermally resilient designs for buildings in cold climates should include consideration of increased thermal resistance of the building envelope, improved whole-building airtightness, and higher thermal mass.

Air tightness of 0.15 cfm/ft² at 75Pa in cold climates is achievable and results in significant energy use reduction and improved energy resilience of buildings. Special consideration should be given to air barrier details at the roof/wall joints.

Specific building envelope designs and their characteristics vary country by country. This Guide's intent is to provide an additional consideration for authorities having jurisdiction (AHJ) when they are setting their building envelope guidelines for thermal energy system resilience for buildings located in cold and Arctic climates.

Table 4-4. Building envelope characteristics for mass and frame buildings located in cold and arctic climates used for study of interior temperature decay when heating is interrupted.

Building Parameters	Mass Building			Frame Building		
	Pre-1980	Low Efficiency	High Efficiency	Pre- 1980	Low Efficiency	High Efficiency
Walls R-value, °F·ft²·hr/Btu ([m²·K]/W)	20.5 (3.6)	40 (7.0)	50 (8.8)	20.5 (3.6)	40 (7.0)	50 (8.8)
Roof R-value, °F·ft²·hr/Btu, °F·ft²·hr/Btu ([m²·K]/W)	31.5 (5.5)	45 (7.9)	60 (10.6)	31.5 (5.5)	45 (7.9)	60 (10.6)
Air Leakage, cfm/ft² at 0.3 in. w.g. (L/s.m² @75Pa)	0.4 (2)	0.25 (1.25)	0.15 (0.75)	0.4 (2)	0.25 (1.25)	0.15 (0.75)
Window U-value, F·ft²·hr/Btu [W/(m²·K)]	Double Pane 0.56 [3.18]	Double Pane 0.30 [1.70]	Triple Pane 0.19 [1.07]	Double Pane; 0.56 [3.18]	Double Pane 0.30 [1.70]	Triple Pane 0.19 [1.07]
MaxTTR Habitability (60 °F)	1 hour	3 hours	10 hours	< 1 hour	2 hours	4 hours
MaxTTR Sustainability (40 °F)	20 hours	36 hours	51 hours	10 hours	18 hours	24 hours

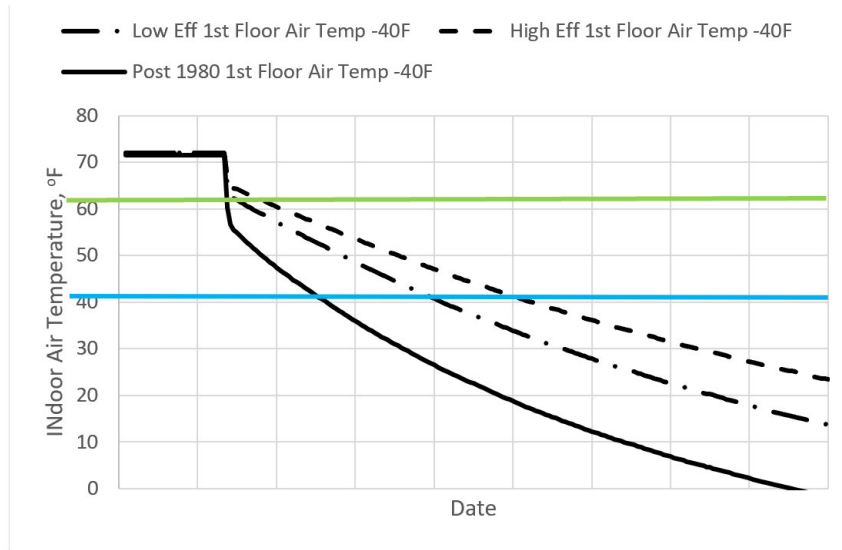

1/10 1/11 1/12 1/13 1/14 1/15 1/16 1/17 1/18 1/19

a

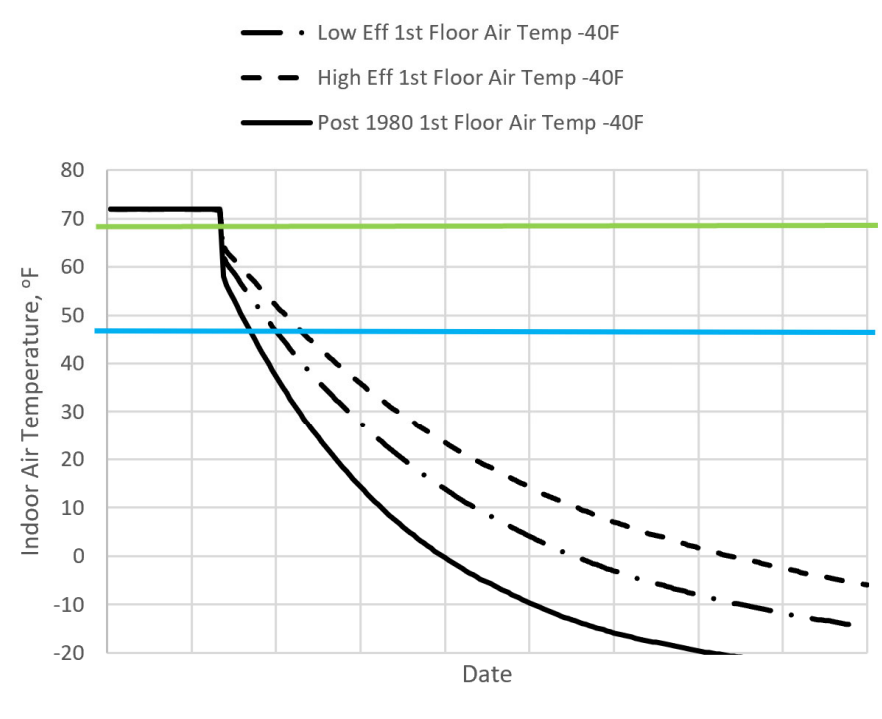

1/10 1/11 1/12 1/13 1/14 1/15 1/16 1/17 1/18 1/19

b

Figure 4-11. Indoor air temperature decay in a high-efficiency building vs. a lower efficiency building when heat supply is interrupted at outside air temperature -40 °F (-40 °C): (a) thermally massive building, (b) framed building.

CHAPTER 5. CONSIDERATIONS FOR FOUNDATION CONSTRUCTION ON PERMAFROST

5.1 What is permafrost?

Permafrost, which by definition can be comprised of frozen soils, ground ice, or bedrock, generally provides rigid base material suitable for arctic infrastructure foundations. Due to the current climate warming trend, permafrost temperatures are rising in Alaska and other circumpolar nations and increases in damaged infrastructure due to the rising temperatures are now becoming a problem for some locations. If these changes continue, it is expected that structures at many locations designed based on maintaining permafrost in the frozen condition, especially those located in warmer discontinuous permafrost zones, may begin to see serious distress within the next decade. Local climate patterns and future projections for permafrost condition during the anticipated lifetime of a structure must be incorporated into engineering designs. This can be additionally supported by hazard assessments of existing infrastructure to identify where failures are most likely to appear if permafrost warms or severe weather events occur.

Of particular consequence to engineering, operations, and logistics is the ice content of the permafrost. Permafrost can be used as a base for infrastructure but of major consideration is the strength of the material if/when it thaws. The amount and type of ground ice present is the main characteristic. If materials are ice-poor, they may be considered potentially thaw-stable maintaining high bearing capacity upon thawing and continue to support infrastructure even during and following thaw. Bedrock and low ice content gravel are examples of this type of material. Ice-rich permafrost is generally considered thaw-unstable and warming can lead to catastrophic problems for infrastructure due to differential settlement.

Permafrost ground ice can exist interstitially in the soil or rock pore spaces acting to bind the soil and rock particles together, but it can also exist as much larger ice mass features meters in dimension, such as ice wedges and segregation ice. Ground ice varieties include pore ice (interstitial water was present between soil grains before freezing), segregation ice (ice layers created by gravity, diffusion, and capillary action during freezing), and intrusive ice (ice wedges or subsurface cave ice emplaced after the surrounding ground has frozen). All these ice types can be present in the same location (Figure 5-1). Ice strength is temperature dependent, where near freezing ground ice temperature is over a magnitude weaker in adfreeze (shear) strength than ground ice at 21 °F (-1 °C).

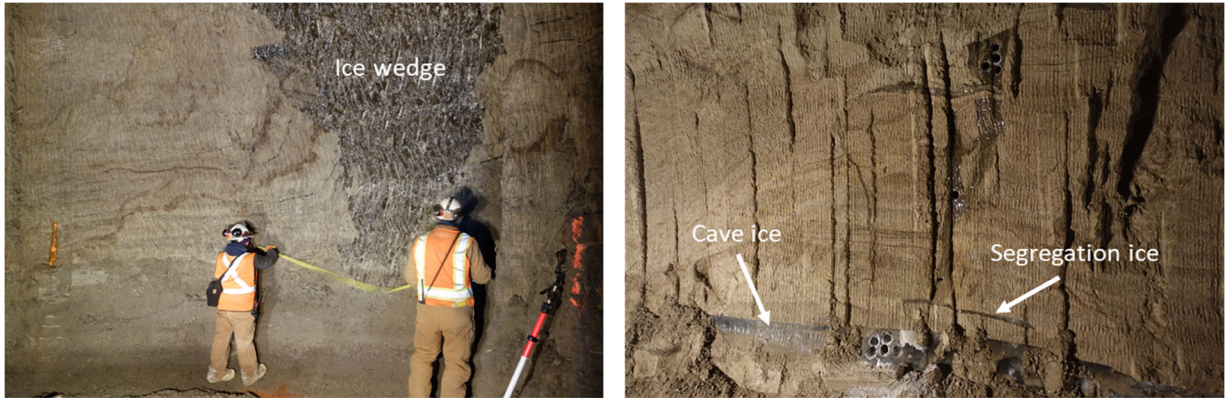

Figure 5-1. Images from inside the ERDC-CRREL Permafrost Tunnel in Fox, Alaska identifying some of the common ice features present in permafrost. The small ice core holes in the image on the right are 8 cm in diameter. Photos by T. Douglas, CRREL.

When direct or indirect heat from the infrastructure warms and thaws the frozen ground, melting of ground ice causes soil displacement and subsequent surface subsidence. Differential settlement tolerance is generally low for vertical infrastructure. For example, centimeters of thaw settlement or ice creep (ice deformation) can cause poorly operating doors and windows, floors become un-level, and in a worst case, the structure begins to fail as walls crack and foundations fail (Figure 5-2).

Prevention of settlement is the main objective in permafrost engineering, either by removing or bridging over ice-rich soils and allowing for infrastructure heat to thaw the subsurface with no consequences, or the frozen ground is kept in the frozen state. Using unique engineering methods, permafrost has successfully supported many different types of infrastructure, both vertical (e.g., buildings, towers, fuel and water tanks) and horizontal (e.g., runways, roadways, and pipelines).



Figure 5-2. Left: A photo of a meeting room at a site in Thule, Greenland, where differential settling has led to wall and ceiling cracking. Photo by T. Douglas, CRREL.

5.2 Construction on permafrost

Engineers use various methods to construct on frozen ground. The type of solution is dependent on the amount of ground ice within the proposed infrastructure thaw zone, the type and layering of the soil or rock, the structure's intended use, expected life span, and lastly the acceptable risk of failure. When the soil is an alluvial gravel, common in valley bottoms in arctic regions, the ground ice consists primarily of matrix ice and little to no massive ice, the resulting thaw settlement will be low for this soil type and often is termed "thaw-stable." Elsewhere where alluvial gravel cannot accumulate such as on hill slopes and ridge lines, finer grained air fall sediments are often found, these silts and remobilized sandy silts can contain extreme amounts of ground ice, both matrix ice in excess, and also massive ice. The resulting settlements are very large for this soil type and is most often termed "thaw-unstable." For example, one engineering option is the total excavation of near surface ice-rich soils and replacement with compacted gravel fill with an additional cost to the structure of only a few percent. Another option is to construct elaborate refrigerated foundations, either mechanically or via ambient methods, to insure soil rigidity and long-term safety with low risk, at up to 50% additional cost.

Therefore, the most critical aspect for any engineering project on permafrost is ascertaining the ground ice and soil characteristics at all relevant locations (Bjella 2012a,b,c). Borehole drilling provides the highest resolution of subsurface conditions, but results are only applicable at the location of sampling. Because permafrost can be highly heterogeneous extrapolating borehole results is risky, and borehole drilling is costly and time consuming. Surface based geophysical techniques like electrical earth resistivity tomography (ERT) and ground penetrating radar (GPR), when combined with ground truth from boreholes or excavations, can be used to characterize the subsurface of a project site (Kneisel et al. 2008; Figure 5-3).

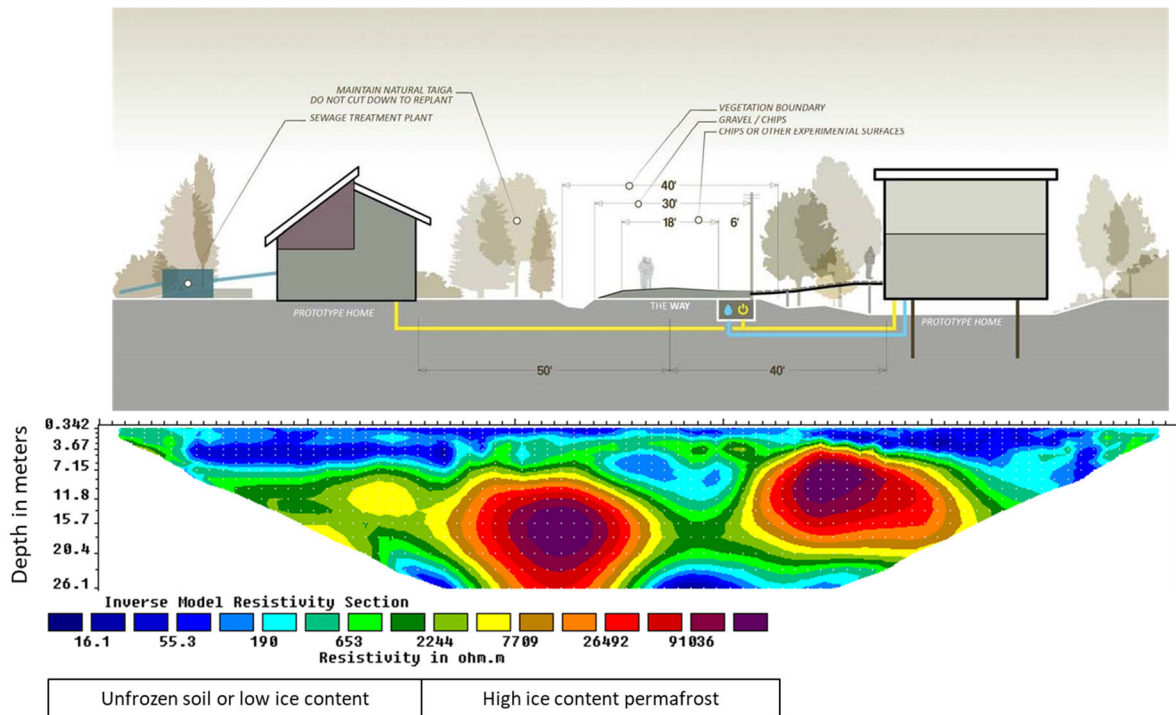

Figure 5-3. A schematic diagram showing how electrical resistivity tomography can help guide infrastructure siting and design decision making. The area of low ice content permafrost or unfrozen soils (left, with low resistivity values) is suitable for slab on-grade construction. The area on the right, where there is high resistivity indicative of permafrost, is suitable for a structure on posts or piles.

5.3 Foundation options on permafrost

Foundation options on permafrost vary widely and are dependent on intended use, allowable risk, budget, location (climate and permafrost characteristics), and logistical constraints.

Consequently, foundation alternatives range from rather simple to extremely complex. As mentioned previously, shallow ice-rich layers can be excavated and removed, whereas deeper lying ground ice may require the structure to be elevated on piles or columns/pads to allow for winter air to flow under the structure. Generally speaking, colder permafrost temperature is easier to engineer as thermal equilibrium is more difficult to disrupt to the point of thawing the ground ice. Therefore, discontinuous permafrost is much more sensitive to instigation of permafrost thaw and the longer and warmer summers make it more difficult to maintain frozen ground with ambient air-cooling methods only. One more complication is that ground ice content as a subsurface feature is difficult to detect and map accurately, especially where its presence is discontinuous or sporadic and masked by surface vegetation. Therefore, extensive site characterization surveys are essential to understand the best engineering alternatives. Proper characterization uses a combination of geophysical interrogation methods, with ground truth via borehole drilling and soil sample testing.

Impacts of permafrost thaw can be mitigated by removing ice-rich or fine-grained ice cemented surface material (Figure 5-4), allowing for more traditional foundation designs like buried footers with slab on-grade floor systems. Passive refrigeration systems use elevated structures (Figures 5-5 and 5-6) and strategic use of insulation. Adjustable foundations have shown increasing promise in areas

where construction must occur on top of degrading or high-risk permafrost. Active systems include mechanical refrigeration or thermosyphons to maintain a frozen base. Future designs must consider the rates of projected climate warming in a given location as the properties of the foundation materials will also change accordingly. Horizontal infrastructure (roads, bridges, airfields, pipelines, etc.) that are permanent (i.e., not seasonally dependent like frozen roads) are designed to either passively or actively maintain a stable frozen base.



Figure 5-4. Removal of surface ice-rich permafrost and backfilling with thaw-stable materials allows for large slab on-grade construction. Photo by K. Bjella, CRREL.



Figure 5-5. Examples of elevated structures on permafrost. Upper photo: An image of downtown Utqiagvik, Alaska where single-story and multi-story buildings, as well as all utilidors, are constructed above ground. Lower left: a large facility at Prudhoe Bay, Alaska. Lower right: a single-story structure at Thule, Greenland. Photos by Kevin Bjella, CRREL.

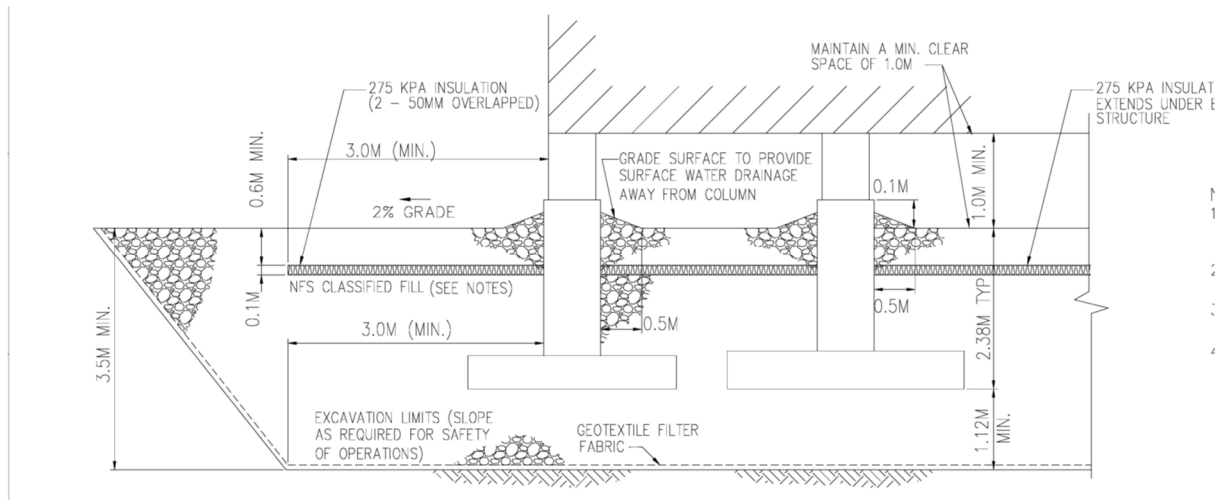

Figure 5-6. A cross-section of a buried footer design used at Thule, Greenland.

Alternatively, mechanical freezing may be prescribed using buried refrigeration loops either with mechanical cooling or thermosyphons. These devices (also known as heat pipes) (Figure 5-7) consisting of a sealed vertical pipe embedded into the subsurface material that is to be maintained frozen, and they are exposed at the surface. Pressurized liquid, commonly carbon dioxide, pools at

the bottom and absorbs the heat (evaporator) of the surrounding permafrost. The chemical evaporates and the resulting gas rises to the top of the pipe (condenser) where the vapor cools and condenses and releases heat to the atmosphere through a cooling fin structure. The cooled liquid returns to the bottom of the pipe to complete the cycle (Figure 5-8). This type of system only cools the ground when the ambient air temperature is colder than the soil to be frozen, and when properly designed and installed enough cooling can be accomplished during the winter to maintain a frozen subsurface through the following summer.

More than 88,000 thermosyphons are used to maintain frozen ground along the 800-mile Trans-Alaska Pipeline System. Recent advances include the flat-loop thermosyphon (Yarmak and Long 2002), which is ideal for cooling floors and other expansive flat surfaces. The hair-pin thermosyphon (Xu and Goering 2008) is optimal for locations where exposure of pipes above the surface cannot occur for operational reasons like roadways or runways. Though heat pipes are highly effective, they are costly to implement and moderately costly to maintain. Active thermosyphons also known as hybrid (where refrigerant and an electrical pumping system are used for delivery) have been used to construct “ice walls” in areas where permafrost is not naturally present or needs additional assistance to maintain the frozen condition through the summer season. The largest implementation of this extremely costly and long-term implementation of thermosyphons is along the coast of Japan as part of the remediation for the Fukushima nuclear reactor spill.



Figure 5-7. Images of thermosyphon installations. Left: on the Trans-Alaska Pipeline near Fairbanks, Alaska. Upper and lower right: along foundation edges of structures in Prudhoe Bay, Alaska. Images by T. Douglas, CRREL.

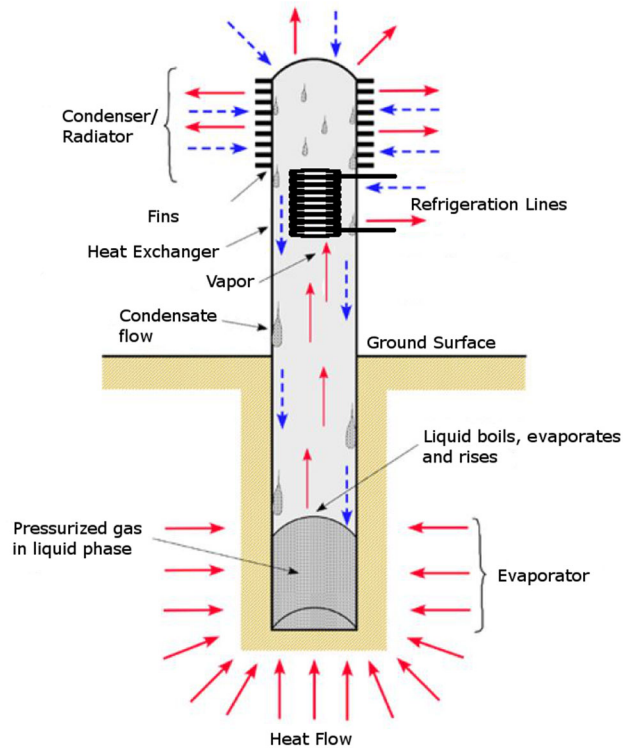

Figure 5-8. A diagram illustrating the functions and operations of a typical passive thermosyphon with 'active' refrigeration coil addition for hybrid applications. Source: Wagner (2013).

Some of the vertical foundation techniques currently used include (from Bjella et al. 2013):

- Maintain frozen ground with a powered refrigeration system
- Maintain frozen ground with a non-powered refrigeration system (passive heat pipes)
- Elevate the structure on columns allowing ambient winter air to maintain permafrost
- Incorporate air ducting in the flooring system allowing ambient winter air to maintain permafrost
- Strengthen the foundation and allow for thawing of soils (ice-poor, coarse-grained sediments/rock)
- Remove ground ice to an economical depth replacing with select fill material.

CHAPTER 6. BEST PRACTICES FOR HVAC, PLUMBING AND HEAT SUPPLY

6.1 Introduction

Arctic climates can experience extremes with high summer temperature spikes to extensive periods of cold temperatures and darkness during the winter. Building owners have typically been willing to increase first cost investment on both reasonable energy reduction measures and reasonable comfort measures. In cold climates, the indoor environment can be a welcome relief for occupants and for many, there are more hours spent indoors than outdoors during the winter months. Creating a good indoor environment with comfortable, reliable, and sustainable spaces is a high priority and design decisions should consider the life cycle cost effectiveness of building and energy systems holistically, including current and future anticipated functions.

To provide a design that is robust, adaptable, and affordable, it is important to understand the aspects of the geographic location that will impact equipment selections, operating hours, and maintenance needs. Another consideration is the ability of a building to withstand an outage in the heating plant, either locally or from a centralized source.

In extreme cold climates, a drop in indoor temperature can pose a risk of freezing plumbing and wet sprinkler piping. Freezing pipes can lead to pipe burst and flooding of the interior. Pipe breaks due to freeze conditions are common in Alaska in both commercial and residential contexts. Flooding in commercial buildings can cause enormous damage and cost thousands of dollars to repair in addition to the impact of the loss of workspace in an office building.

Therefore, it is necessary not only to look at the building HVAC installations, but on the building envelope and the whole energy infrastructure. The large thermal capacity of concrete and brick walls, internal water pipes, critical system redundancy, a reasonable layer of outside insulation without weak point can offer protection from unpredicted outages.

6.2 Heating systems

6.2.1 Specifics of heating systems in Arctic climates

Unlike in comparatively warmer climates, heating with air is not typical in construction in cold climates. This is due to high heating loads. Heating with air in a commercial application should be used with caution. Air heat from above is not effective unless it reaches the floor, and it cannot reach the floor from above without significant velocity. Since the density of warm air is less than that of cold air, chances are that without sufficient velocity it will remain at ceiling level, outside of the working area of the occupants of the space.

As noted, heating systems in arctic climates are considered critical infrastructure. It may take days or even weeks to get a failed heating system component fixed and operational. Resiliency in mechanical system design is first achieved through system redundancy. Examples of this include:

- Two or more boilers sized to be able to keep the facility above freezing under reduced operational conditions with one unit down for maintenance. Reduced operation may include temporarily turning off the ventilation system. This has traditionally resulted in two boilers sized at 66% of peak heating load or three boilers sized at 50% peak load.
- For critical pumps, such as main circulating pumps, two pumps are provided in a primary/backup configuration with independent starters/variable frequency drives and power circuits.
- The use of multiple heat sources. This may be adding gas fired roof top units to a hydronic system, having fuel-fired space heaters, or having a solid fuel backup heat source.
- Multi-fan arrays where ventilation is a mission critical part of the facility.

In critical infrastructure, this may mean the use of N+1 levels of redundancy at all levels of the building systems including power generation and controls.

6.2.2 Working fluid

Hydronic heating is the preferred method and typically uses a glycol/water solution as the heating system fluid. This provides freeze protection and allows the heating system fluid to be used in air handling unit heating coils that heat incoming air that could be as low as -60 °F (-51 °C). Glycol to water percentages are selected based on a conservative winter design temperature and either the glycol's associated freeze or burst protection volume percentage. Typical glycol mixture percentage in extreme temperature zones is 50% with some building owners opting for up to 60% glycol heating system fluid. There is a thermal performance derate and significant viscosity increase when using glycol over water, which must be considered when designing hydronic systems. Ethylene glycol and propylene glycol are the most typical heating system mediums. Ethylene glycol performs better from a derate and pressure drop perspective as compared to propylene glycol. However, in some cases it may be preferred to use propylene glycol as it is not toxic to humans.

Chiller systems that are expected to be filled and/or operated year-round also use glycol. The preferred fluid for these systems is ethylene glycol due to the better viscosity performance at lower temperatures.

In addition to a performance derate, the wetted surfaces of equipment must be compatible with glycol to prevent premature failure of components. The most common issue is pump seals and system gaskets, which should be selected to be compatible with the glycol mixture concentration. Glycol is also susceptible to degradation under high temperatures, under which conditions it can form acid molecules. It performs well in cast iron sectional boilers but can degrade in water-tube boilers.

Glycol requires regular maintenance to ensure that it maintains a proper pH balance and sufficient corrosion inhibitors. Improperly maintained glycol can become acidic, and can subsequently corrode pipes and gaskets, and seize control valves. It is recommended that glycol be tested annually for pH and glycol freeze protection, and that glycol fluid samples be sent to a testing laboratory for inhibitor and other chemical analysis on a regular basis.

When using glycol as a heating or cooling medium, it is recommended that the system not be connected to the domestic water system for make-up as is traditionally done with water-based systems. A standalone, automatic feed glycol make-up tank is recommended. History has shown that water make-up systems will slowly dilute the glycol over time, either through unseen system leaks or maintenance drain-down operations. This lower glycol percentage results in freezing and bursting of coils.

6.2.3 Perimeter heat using finned tube radiators

The high-thermal flux across the building envelope is best addressed at the bottom of the envelope with either finned tube radiation (FTR) cabinets or radiant panel heating. In areas of significant glass such as architecturally appealing entry lobbies this is typically handled with FTR cabinets. Heating with FTR cabinets is most economical when using high fluid temperatures of about 180 °F compared to floor radiant heating systems that typically should have a maximum fluid temperature of 120 °F. This makes combining the two systems using a single distribution system difficult and expensive as it requires separate piping systems or a control valve and pump at each radiant manifold. When using cast iron sectional boilers, the return water temperature should be considered during design. A temperature differential that is too high can result in cracked sections that render the boiler inoperable. When using condensing boilers to achieve maximum efficiency, the return water temperature should be low enough to utilize the condensing feature of the boiler.

A benefit of using finned tube and radiant panel radiators is their ease of renovation. In applications where renovations are expected at relative frequency, use of these approaches is recommended. Heating zones are easily modified, and piping is accessible in the ceiling space or below the floor.

Compared to radiant slab heating systems, which are discussed in the following section, perimeter radiant heat using finned tube or radiant panels radiators will result in temperature degradation during an outage or equipment failure that is faster than that associated with a radiant slab heating system due to the high-thermal mass of the heated slab (Figure 6-1).

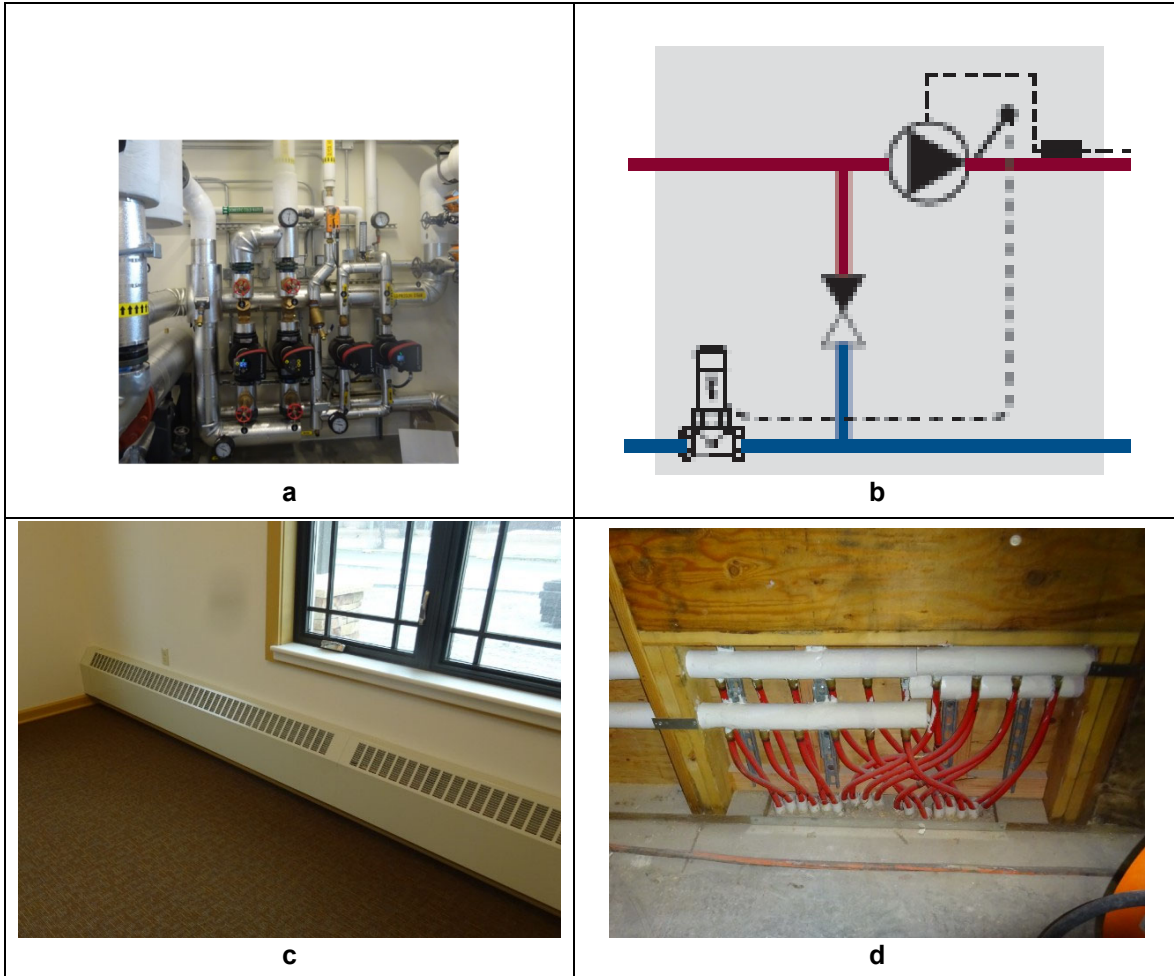

Figure 6-1. Hydronic heating system: (a) system interface with district steam system (designed by Design Alaska); (b) mixing shunt; (c) finned tube radiator at a perimeter wall; (d) radiant tubing manifold during construction.

6.2.4 Radiant slab heating

In-floor radiant heating, also known as radiant slabs, can be used successfully to address building heating load, but the output is limited by the allowable surface temperature before it exceeds the rated temperature of the flooring assembly or acceptable floor temperature for given building function. For example, in areas where sedentary work is performed, such as many office spaces, floor surface temperature based on comfort and safety when wearing normal footwear is limited to 84°F (29°C) that results in the flux capacity for floor based radiant heating system limited to 31 Btu/hr ft² (99 W/m²) [ASHRAE, 2017; Robert Bean, 2006]

A driver for many building owners opting for radiant heating systems is the quality of heat it provides. Radiant heating provides a fairly uniform heat, which is welcome during cold periods in arctic climates. Since the heating is within the floor assembly, the furniture layout is not driven by the location of heating terminal units as is sometimes the case with FTR cabinets.

Building owners and system designers should consider the ability to renovate spaces when selecting radiant slab heat. When tubing is located within the slab, relocating interior walls can require careful

coordination to avoid puncturing a tube when anchoring new walls into the slab. In some cases, tubing is located in a sand bed below the slab to allow for anchorage into the slab during initial construction and in the future with limited risk of damage to the radiant tubing. Locating the tubing in a topping slab would also be a consideration. In this case, the tubing would be re-poured in a remodel. All radiant floor systems should use insulation under the slab (or under floorboards in staple-up applications) and at the slab perimeter to direct the heat upwards towards the occupant and improve heating efficiency. In garages and hangars, it is recommended to install a hydrocarbon resistant liner above the insulation to ensure that fuel and oil leaks do not erode rigid insulation.

Another complication of radiant heating is zoning. While heating zones can be customized to the current programming during building design, this can change dramatically over time. Additional zones results in additional cost for construction, therefore spaces with similar load are often zoned together with the controlling temperature sensor located in the highest priority space, a manager's office in an office space for example. A downfall to fewer and larger zones is that it is less adaptable to floor plan changes. A remedy to this challenge is to have many smaller zones in a grid pattern provided the project budget can sustain the added cost. Types of spaces that are typically renovated often, such as hospital patient treatment areas, should be considered with care. Significant cost may be added to all future renovations to accommodate the needs of programming changes.

Manifolds should be located at permanent features such as bearing walls or columns as placement of these elements will likely remain unchanged in future renovations. Manifolds can also be located in interior walls near fairly permanent spaces such as mechanical rooms or bathroom groups as these walls are typically more consistent during the life of a building compared to typical space divider walls. With larger diameter tubing, the manifold itself can be done away with for smaller rooms. The radiant tubing can be routed up to the ceiling space to avoid the need to provide wall access panels. The use of a radiant slab system can improve a building's resilience due to the high-thermal mass of the slab itself. In comparison to similar counterparts with FTR cabinets and radiant panels, these buildings will perform better in a thermal degradation test in which the heating system is disabled. This can be of great benefit to building owners with unreliable heat plants and frequent outages, which is common in remote sites in Alaska.

In the same way that temperature loss is slowed with the use of radiant slabs the ability for a space to maintain setpoint temperature is also reduced. Radiant slabs are slow reacting, both to heat up and to cool down, therefore design consideration should be given in areas that may experience rapid temperature loss such as garages and loading docks. In these areas it is typical to provide a supplementary hydronic unit heater, which can pick up temperature quickly before freezing of plumbing piping becomes a risk. Care must also be taken when locating plumbing within areas with garage doors or other large openings. For more information about radiant systems see (ASHRAE 2019, Robert Bean 2006 and B. Olsen 1977)

6.3 Centralized and decentralized heat supply systems

Historically, in the Fairbanks area in Alaska the majority of commercial building owners who are not connected to district steam or heating water call for redundant boilers. Until recently these were almost exclusively fuel oil-fired, cast iron sectional boilers. Owners of large facilities stock spare parts for these boilers to reduce downtime and this approach has worked well to prevent freeze up conditions due to equipment failure.

With the introduction of natural gas, this has stayed virtually the same except that natural gas boilers rely on the natural gas distribution system. In Fairbanks, natural gas arrives as liquid natural gas (LNG), which is vaporized and distributed through underground piping. To date, these systems have been comparable in reliability to oil-fired equipment except that the variety of gas fired boilers is much greater.

Local schools and the hospital operate dual fuel boilers that switch between oil and gas depending on the cost and availability of gas. When the distribution system is heavily loaded there is an arrangement with the utility whereby these users switch back to oil.

The two military bases in the area rely on district steam generated by coal fired cogeneration power plants. These plants distribute steam through below ground utilidors at medium pressure between 65 to 85 psi (448 to 586 kPa). Once inside the building the pressure is reduced to 15 psi (103 kPa) low-pressure steam where it is typically used in a shell and tube heat exchanger to produce high temperature glycol for distribution throughout the building to heating terminal units. The utilidors are also used to distribute domestic water and sometimes sanitary sewer.

Scandinavian experience with heat supply systems in cold climate shows that there are many advantages to use hot water district heating compared to steam systems, in particular low temperature system with a maximal supply temperature of 212 °F, for example:

- Simple system to be operated and maintained in remote areas
- Low risk and more resilient in case of break down
- Access to many efficient low carbon heat sources, not least free heat from local diesel generators
- Ability to store at low cost in thermal storage tanks
- Lower heat losses
- Lower total costs.

In some small communities in Greenland with micro grids, a significant part of the heat demand is produced by excess heat from diesel generators.

To improve their resilience, distribution networks for building heating serving mission critical facilities can include redundant branches configured as loops sectioned by stop valves (see Figure 6-2) that ensure heating energy backup (Gudmundsson et al. 2020). Chapter 7 presents more information on district systems.

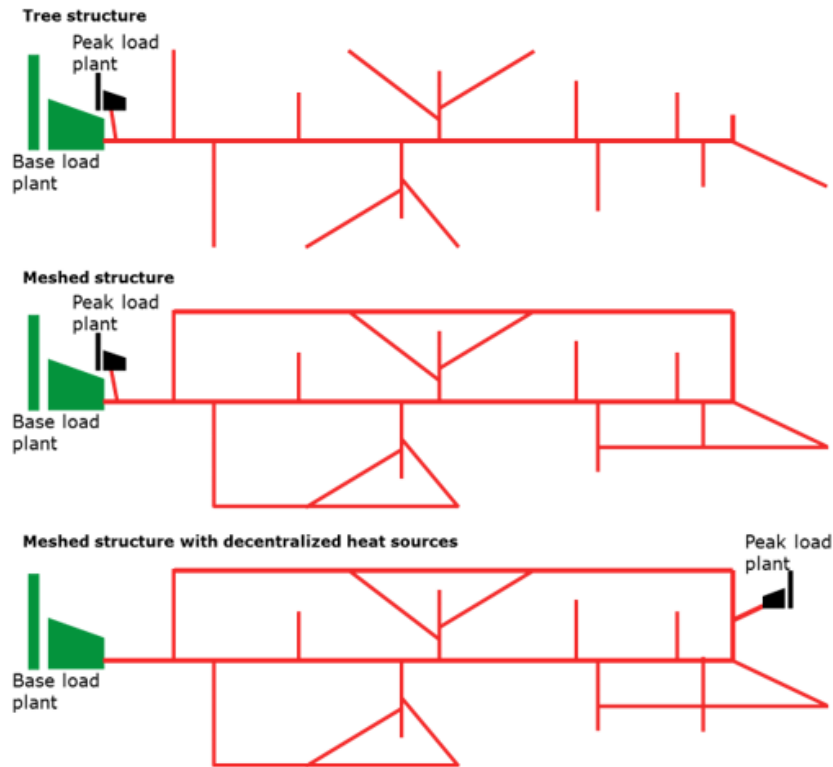

Figure 6-2. Heat supply strategies using local backup or a meshed network structure

6.4 Cooling

Although Interior Alaska has high record temperatures exceeding 91 °F, the number of annual hours of mechanical cooling that is required is low, about 70 days above a 65 °F base annually. Therefore, the least expensive form of mechanical cooling, direct expansion refrigeration (DX), is typically most appropriate.

DX systems function through the refrigerant vapor expansion and compression cycle. Refrigerant in the evaporator coil, often located within an air handling unit, cools air passing across the coil by absorbing heat from the airstream. Refrigerant is returned to the condenser to reject the absorbed heat to the ambient. Typically, a condenser is located on a pad outside where it can reject heat to the ambient; however, this can pose some challenges.

Due to the low angle of the sun during the winter and shoulder seasons as well as the amount of time on the horizon, many buildings will require cooling even when the outside air temperature is below the occupied space temperature. The preferred method of cooling during these conditions is the use of an economizer function that increases the percentage of outside air in central ventilation systems. Other systems that require cooling year-round, such as data centers, may not be conducive to either the low-humidity air from a central ventilation system or the limited occupancy schedule; a mechanical cooling system is preferred. Depending on the operating temperature range of the outdoor condenser, it may not be recommended to run the condenser and these outside air temperatures. This can be mitigated, to some extent, by selecting condensers that have low ambient options, extending the operating range.

Advantages of DX systems are that they have a relatively low installation cost, they provide high performance, and (compared to chillers) they have a low noise level.

For larger, year-round cooling loads, a closed loop, chilled glycol system may be desired. The preferred exterior heat rejector is a multi-fan, dry cooler rather than the use of cooling towers due to the potential for freezing. Piping can be done to bypass the chiller during the winter months and use “free-cooling” through the dry coolers to reject the heat.

Mini split systems, sometimes referred to as ductless or split A/C units, have been used successfully particularly in renovation projects where retrofitting a cooling coil into an air handling unit or ductwork is not feasible. In this application small wall or pad mounted condensers are located outside or in a mechanical space. Evaporators are located in occupied spaces and can be integrated into the ceiling grid or mounted on the wall. Routing condensate to a mop sink or floor drain can be a challenge depending on the location of the evaporator; therefore, selecting a unit with a small condensate receiver and pump provides more flexibility in pipe routing for condensate disposal.

While technology such as chilled beams might save energy, the payback is very low. These and similar systems have not been adopted due to increased maintenance and high first cost. Well water cooling systems have been successful, particularly in applications where the rejected water can be discharged to the storm drainage system. Reinjection has been successful as well but is coming under increasing regulatory scrutiny due to the fact that the system might move or influence ground water pollution sources. All designs that intend to use well or domestic water for cooling should be first vetted by the local utility as well as local environmental permitting agency.

6.5 Specifics of ventilation systems in arctic climate

6.5.1 Heat recovery

Heating the required outside air is costly. This load can be offset by recovering the heat in the exhaust air stream. Heat Recovery Ventilators (HRVs) can be used to reduce the size of coils and the load on the heating plant by extracting heat from the exhaust air stream that would otherwise be discharged to the outside (Figure 6-3).

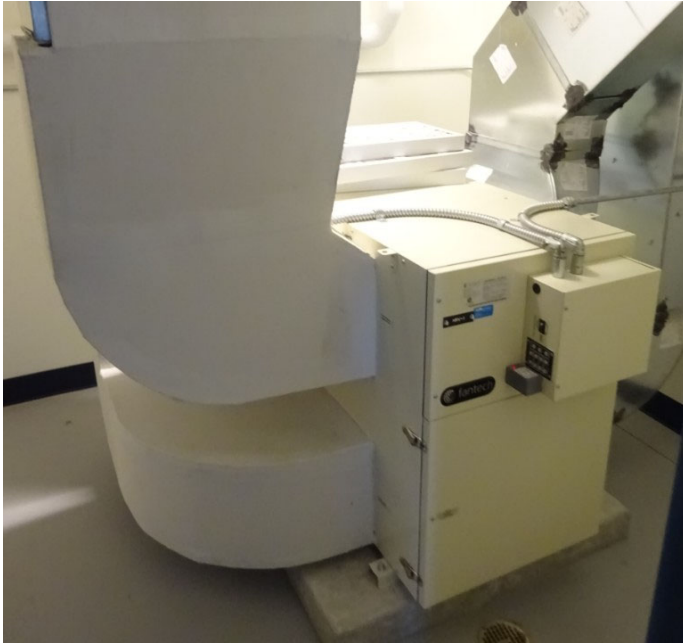

Figure 6-3. Small Light Commercial HRV.

Different types of air-to-air heat recovery cores and systems are available. The ASHRAE *Cold-Climate Buildings Design Guide* (ASHRAE 2021) gives additional information. These systems all have their use and there are applications where one technology may be more appropriate than others. The most common technology used in cold climates is the plate-style heat recovery core.

Certain considerations must be made when using HRVs. Due to low outside air temperatures, the exhaust air stream through the heat recovery core can frost to the point that air is restricted or completely blocked. A common packaged controls method of defrosting the heat exchanger in commercial equipment is to turn off the outside air and allow warm exhaust air to defrost the exhaust air stream. In a commercial building where ventilation is required by code, it is typically unacceptable to have no outside air ventilation during occupied periods. ASHRAE 62.1 (ASHRAE 2019b) does have an exception that allows temporary loss of outside air ventilation; however, the conditions that allow this practice are limited and often cannot be met in an office space. In smaller residential type units, the defrost function is done by recirculating the exhaust back into the supply air system. Since the exhaust side of a HRV is typically taken from restrooms, this functionality is not code compliant in commercial and multi-family type applications.

To prevent frosting of the heat recovery core, hydronic preheat coils can be installed in the outside air duct before the HRV heat exchanger. These coils must have glycol. The use of preheat coils in a ventilation system is common in cold climate mechanical system design for energy efficiency and controllability of adding heat to an air stream. With preheat coils, two filter banks are provided. One filter upstream of the coil, referred to as the “summer filter” that protects the coil from dirt during the summer and a filter bank after the preheat coil referred to the “winter filter.” The reason for the winter filter is that during the winter, extreme cold temperatures can frost and plug filters installed upstream of the preheat coil. The winter filter is typically located where the air stream temperature is above freezing. A filter is only located in one of these locations and is switched seasonally.

The ASHRAE *Cold-Climate Buildings Design Guide, Second Edition* (ASHRAE 2021) provides more information and control strategies for preheat coils and summer/winter filter configurations.

For HRV defrost control, preheat coils should be sized to heat incoming air to keep the exhaust air stream just above freezing. The higher the temperature delta across the core, the more efficient heat transfer will be; therefore, incoming outside air should be heated only as much as needed to prevent frosting. A heating coil will be needed after the core to bring the final delivery temperature to an appropriate range for occupied spaces.

Due to the exceptionally dry air in cold climate buildings, some control strategies have extended the frost control strategy to using dew point of the exhaust stream as the control setpoint. This allows the exhaust air to be below the dry bulb freezing temperature without frosting (because it is above dew point), increasing the temperature differential and thereby increasing the heat exchange efficiency. This can also result in very low supply air temperatures downstream of the heat exchanger so this must be considered in sizing of the main heating coil, or a secondary stage of preheat coil control is added that maintains a set inlet air temperature on the main heating coil or discharge air temperature setpoint.

Note that the outside air stream may be below freezing after the preheat coil and in some extreme locations, even after the heat exchanger. Therefore, the “winter filter” may need to be located after the heat exchanger to remain frost-free. The operating conditions should be carefully modeled by the designer and equipment manufacturer to ensure that the heating coil is adequately sized to bring the air up to discharge temperature setpoint.

While HRVs do not eliminate the need for heating coils, they can offset the load, which saves energy and operating cost for the facility. It is not uncommon in extreme cold environments for the ventilation system to be the highest heating load in the building, even more than the heating load across the building envelope.

Heat recovery systems should be designed to be able to bypass or turn off the heat exchange function when the outside air temperature is above the supply temperature setpoint.

The ASHRAE *Cold-Climate Buildings Design Guide, Second Edition* (ASHRAE 2021) discusses the best practices related to ventilation openings and how to avoid common mistakes. Ventilation system air intakes require careful consideration due to frost buildup, snow, and wind. For more information on air intake designs specific to cold regions see the ASHRAE 2021 *Cold-Climate Buildings Design Guide, Second Edition*.

6.5.2 Humidification system design

Historically humidification of commercial buildings in Alaska is uncommon with the exception of hospitals and process sensitive spaces requiring humidity to be controlled within certain limits. During the winter months, the humidity of outside air is almost zero meaning that a significant amount of moisture must be added to increase to a given setpoint. In recent years, humidification has been considered more broadly. In the absence of specific humidification requirements typical spaces that are humidified include data centers, server rooms, fitness centers, and hospitals.

It is generally accepted that the recommended relative humidity levels for human health is minimum 30%. When humidifying to this level there are important factors that need to be considered to ensure that it is done correctly and limit the risk of harm to the building structure.

In many cases, a significant amount of moisture must be added to the air to meet a setpoint of 30% relative humidity. It is best practice to limit the relative humidity of the supply air in the ductwork to 80% to limit the risk of condensing on the inside of the duct surface. Condensing within the ductwork can lead to mold growth, which is detrimental to human health. Control strategies should be in place to limit discharge air relative humidity.

Electrode canister type humidifiers (Figure 6-4) are comprised of a small reservoir, on board control module, and electrodes extending into the reservoir. The steam outlet piping is connected to a humidification grid or can be discharged to the space depending on the application. This option is somewhat maintenance intensive as the reservoir develops scale from mineral deposits as water is converted to steam and must be cleaned or entirely replaced on a regular basis.



Figure 6-4. Electrode humidifier (www.condairgroup.com/know-how/electrode-steam-humidifier).

Using steam from a district steam source or steam boiler directly is not recommended due to the contaminants and treatments added. An alternative is to use a steam-to-steam humidifier (Figure 6-5) that takes source steam and uses it to generate clean steam, which is used as the humidification medium.



Source: www.armstronginternational.com/sites/default/files/resources/documents/steamtosteam.pdf

Figure 6-5. Steam-to-steam humidifier.

Outbreaks of Legionnaires disease, a form of pneumonia that can be lethal, have been linked to humidification equipment in commercial buildings. Legionella is particularly susceptible to proliferation in stagnant water. Designers should evaluate the potential for stagnant water within the humidification equipment and within any associated tank or canister, during both operating and non-operating conditions, and for the length of time in each condition. Some canister type humidification systems are equipped with an automatic purge function at startup that flushes the contents of the reservoir.

While humidifying buildings has a number of considerations related to the HVAC systems and equipment, it is paramount that the impact on the building envelope be analyzed. For an in-depth review of the building envelope impacts and design considerations for wall assemblies, see Chapters 2 and 4.

6.6 Plumbing system design

Due to low ambient temperatures, it is considered a freezeup risk to locate plumbing piping in exterior walls. Typically, significant design effort is spent locating fixtures such that plumbing piping is located in interior walls or within chases. In the context of resiliency, even piping located within a chase on an exterior wall may be vulnerable to freezing if enough temperature degradation occurs before restoration of the heating system. It is not uncommon for plumbing chases on the exterior of the building to have a heat source with a local thermostat.

Construction of the building envelope can significantly affect plumbing walls. For instance, plumbing wet walls that are built perpendicular to an exterior wall without a continuous vapor barrier between the wall and the exterior wall will allow cold air to enter the wall and freeze water piping. The same is true for interior plumbing walls where the roof vapor barrier has been compromised.

Mechanical rooms pose a freeze potential for water piping as this is typically the location of the water entry and water heater. Mechanical rooms with fuel-fired equipment require combustion air, which is typically brought into the space through a passive opening. If not handled adequately, the cold air can sink to the floor and form pockets of low temperature that are missed by the room temperature sensor. A method to reduce this risk is to provide a unit heater, typically hydronic, oriented such that the discharge faces the combustion air opening. In this case air is heated as it comes into the space, reducing the potential for pockets cold enough to freeze piping to develop.

The International Plumbing Code (IPC) and the Uniform Plumbing Code (UPC) indicate minimum vent through roof (VTR) sizes according to connected drainage fixture units and piping length. In the arctic climate, the saturated vapor discharged through a VTR quickly freezes and generates frost on the outlet pipe. A frosted over vent can disrupt system drainage resulting in dry fixture traps and result in sewage odors entering the building. Some local code authorities in Alaska have instituted an amendment for the VTR to be increased by two pipe sizes before leaving the building to reduce the likelihood of frost closing the outlet. For commercial buildings it is recommended to use a 4-in. VTR if possible, as even 3-in. outlets have been observed to have frosting issues at prolonged cold temperatures. It is recommended that the vent lines be insulated a minimum of 3 ft from the roof penetration and continuously through unheated spaces like attics. In extreme cold locations, the pipe above the roof can be insulated and even electrically heat traced to ensure the vent remains open.

Roof drains are also prone to freezing in extreme climates, resulting in water buildup and potential structural failure. Roof drains, and their associated overflow drains if applicable, should be located above the heated portion of the building with the primary drain heat traced. If the space below the drain is unheated, such as in building canopies or cold roofs, then the designer should consider adding electric heat trace. Overflow drains or roof scuppers within 2 in. of the normal roof drain are recommended and required by code in the United States. It is possible that a stormwater system can freeze underground outside of the building. Overflow spouts on the main storm water line at the building exit point can help protect against such a freeze plugging the line and creating an overload condition on the roof. Typically heat trace is provided at the overflow outlet.

The critical nature of domestic hot water depends on the type of facility. Office buildings may be fine without hot water, but hotels and commercial kitchens cannot function without it. Where resiliency/redundancy is needed in domestic hot water, the use of multiple water heaters is desired. Where natural gas is available, gas-fired water heaters are preferred. Where buildings are heated with fuel oil-fired boilers or a district heating system, the preferred system is the use of indirect-fired water heaters. This reduces the number of fuel-fired appliances, which has traditionally meant less maintenance. With indirect-fired water heaters, the hydronic supply temperature must be hot enough to provide the desired hot water temperature. Redundancy is needed in all components of indirect system including multiple boilers and individual pumps for each water heater.

6.7 Remote site considerations

Nowhere in Alaska are energy costs higher than in a remote Alaskan village that is located off the road system. Here fuel is either flown or barged into the village with fuel costs three to four times higher than fuel costs in a city on the road system.

At the same time, a school located in the village must have more systems and is therefore more complex than a school within a city. Besides being required to meet nearly all the same codes, it must also be able to operate in a self-contained mode not relying on a separate municipal utility system to provide power, potable water, and sewage treatment. The school district maintenance department in Fairbanks has approximately 30 technicians maintaining the schools for an approximate population base of 120,000 people. Most of these school district employees have been trained in a trade, and many have specialties and certifications, such as plumbers, locksmiths, boiler mechanics, generator technicians, controls technicians, and fire alarm technicians to name a few. In the village, there is

often the school principal, a maintenance employee, and a janitor, supplemented with roving maintenance employees flown in to help if there is a major problem.

Therefore, even though energy costs are high, the critical systems must be simple enough to be maintained at a very basic level. Anything that is not critical for basic function often is not adequately maintained due to high cost of flying a technician to the site.

6.8 Best practices for HVAC design in arctic climate remote sites

- Many of the schools were previously designed using commercially sized oil-fired furnaces, reducing the possibility of heating fluid freeze ups and flooding due to circulating air as the heating medium. This practice has now shifted more to oil-fired boilers, which can deliver heat far more efficiently, particularly if the combustion side of the forced air heat exchanger is not regularly cleaned.
- The boiler header temperature setpoint should be reset on outside air temperature by the direct digital control (DDC) system. However, there must be a labeled switch at each boiler that allows a mechanic to easily override the computer control system allowing the boiler mechanic to be independent of the controls technician.
- Radiant in-floor heating is not typically used in remote villages due to permafrost, which forces the building to be built on structural piling. This in turn causes the floors to be plywood. A level rock or gypcrete layout is required as a location for the tubing in this case, which is often too expensive and is eliminated due to cost constraints. Finned tube radiation then becomes the heating terminal unit of choice.
- Utilities are often run above ground due to permafrost. The interface between the aboveground utilities and the building structure must account for differential movement. The sewer or waste piping within a facility is a challenge for a facility built on pilings. The interstitial area below the warm floor and the bottom of the floor structure is typically inaccessible. If piping is routed in this area, the below floor envelope must be cut out to find and repair any leak. After this is done, the below floor construction is usually not repaired well causing infiltration related problems. In one successful project, a central interstitial corridor with about 48 in. height was constructed with nearly all plumbing tight to this corridor. Sprinkler piping was avoided by cladding the metal floor joists with insulated metal panels below and with the use of fire treated plywood for the floor structure above. The interstitial cavity was heated at the lowest point within the corridor allowing heated air to circulate out to the perimeter below the occupied floor and then flow back to the corridor on top of the insulated metal panels making up the lower envelope. This provided reasonable access to nearly all below floor piping.
- Room thermostats should be simple low voltage thermostatic switches used in conjunction with two position control valves. Glycol is used as the heating fluid with a relatively high flow before turbulent flow. Almost no heat transfer occurs before turbulent flow, which causes the control to act like two position control whether or not a modulating valve is used. Night setback becomes proportionally less valuable as envelope insulation increases. One can argue that the system simplicity gained without use of night setback can outweigh the potential energy savings for remote applications.
- The DDC controls controlling the ventilation systems should allow easy manual override to prevent override using wire nuts and vise grips. One example of this is to use spring-wound timers for occupancy override of large portions of the building. An LED light panel, tied to the DDC system, can provide simple operational verification including alarm conditions.

- The communications from the DDC system to the outside world is vital and should be through a telephone modem rather than the internet so that it is not subject to poor or inconsistent IT practices. Many issues with a facilities HVAC system can be remotely troubleshot and, in many cases, fixed by a remote DDC technician using these connections.
- It is recommended that the control system programming at the time of owner acceptance be kept copied and kept with the O&M manual. It is common for these systems to be changed by the owner to the point of nonfunction. Having the copy of the original control language allows a technician to restore the system to its original condition, often remotely.

The subarctic interior environment poses many design challenges. Energy conservation is of the highest importance. However, if the systems become so sophisticated that they require specialists to perform maintenance rather than available maintenance staff or if systems fail prematurely due to complex construction, then the design has ultimately done a disservice to the end user of the facility. When good design comes together, it resonates throughout the life of the facility.

6.9 Operation and maintenance and resilience

When it comes to system resilience, an important first step is to minimize the chance of unexpected system failure that will lead to the need to implement resiliency measures. This is the basis of developing and administering a proactive O&M program. The term “operation and maintenance” covers many facets of facility management. A common definition is the administration of programs that complete preventive maintenance and reactive repair of systems. But it also includes the lobbying of proper funding budgets both in annual funding to complete regularly scheduled maintenance as well as long-term capital improvement project planning that allows for predictive replacement of equipment and systems before they fail. It includes the development of written standards and active involvement in the design of projects to ensure that systems are constructed with maintenance in mind and to minimize long-term operational costs. It includes the ongoing training of both facility maintenance staff and user groups to ensure that systems operate efficiently and effectively.

Operation and maintenance is vital to a successful resiliency plan. It is more likely that the event that generates the need to have resilience in place is caused by the failure of a piece of equipment or system rather than an outside force such as a natural disaster. A robust O&M program will minimize these system failure occurrences.

Resiliency, like redundancy, relies on backup equipment such as generators and secondary sources of heat, and on the ability to quickly get systems back online. O&M is critical in ensuring that these secondary systems will operate when needed. This includes regular testing of equipment such as standby generators, as well as completing scheduled maintenance and overhauls of that equipment and its supporting systems. Standby generators need to have adequate amounts of clean fuel available. For fuel-oil-based systems, this would include regular inspection and testing of the stored fuel to remove water and ultimately replace old fuel with new fuel.

Training, a vital part of O&M, is needed so that operators know how to implement resiliency plans. There must be clearly written checklists, and potentially photos and/or diagrams, available to onsite personnel to assist them in implementing the various plans that should be in place to address multiple threats. The operators need to have familiarity for where key components are located within the facility such as diverting valves or exterior portable generator connections as well as how to manipulate those components to implement a resiliency plan.

If there is a failure and a resiliency plan must be initiated, the ability to quickly get the original/primary systems operational is a combination of both training and having the appropriate tools and spare parts available. Aside from static measures, most resiliency plans are based on activities that are intended to be temporary. The backup solutions are also typically sized to only maintain minimum critical infrastructure such as maintaining a building temperature just above freezing temperatures. The resiliency solution will likely not be sized to provide full indoor air quality or environmental control, leaving occupants with a less than ideal working and living condition. Most secondary systems, such as electric heat, can be very expensive to operate; therefore, the need to get the original systems fixed and back to normal operation is highly important.

Power outages can be caused by a number of sources in cold climates. Snow and ice or high velocity wind storms can cause falling trees on power lines resulting in extended outages, for example. A standby generator is common for commercial facilities. Performing regular maintenance on standby generators will ensure they will operate when needed.

There are several steps to being prepared for urgent maintenance events:

1. Identify points of failure.
2. Maintain an accurate set of Record Drawings of the facility systems design available both in paper and electronically. This will help locate important features such as isolation valves or system diagrams to better evaluate system functionality. Having an electronic copy available will benefit remote technicians in the help of troubleshooting issues.
3. Keep maintenance documentation available onsite for at-risk systems and materials. This is traditionally the Operation and Maintenance Manual. This includes information about the product, exploded view of parts with part numbers, troubleshooting guide, warranty information, and preferably contact information for the local supplier of parts and maintenance technicians (if applicable). This is also beneficial to have electronically and in hard copy.
4. Identify and keep spare parts and tools that will be needed for critical system repair on-hand.
 - a. Maintain an organized spare part location so that parts and tools can be readily found. Complete regularly scheduled inventory of tools and parts to ensure they are available when needed.
 - b. Keeping track electronically of available spare parts and when they are used on a project to ensure that replacement materials are ordered so that they are ready for the next incident.
5. Provide training and/or have training videos available onsite that can show how to perform needed maintenance/repair to the system.

Having static resilience measures in place, like a robust building envelope, provides much needed time when a heating system is down. Training and having thorough O&M and resiliency plan documentation in place expedites the initiation of backup procedures and gets the primary systems quickly back online.

6.10 Conclusions.

The cold temperatures experienced for sustained periods of time in arctic climates makes the design, installation, and maintenance of resilient, robust, and maintainable HVAC systems imperative. The design process must identify points of failure and implement features to limit system downtime and reduce impact on the facility's ability to maintain temperature during planned or unplanned outages.

Redundancy provides a high degree of reliability. Heating system components such as hydronic circulation pumps and boilers should be designed with redundancy such that a failure does not result

in full system failure. This provides building owners with a method of maintaining the building heating system by taking some equipment offline without impacting building functions.

Where practical, emergency measures such as connections for remote boilers may be necessary to ensure functionality of the facility or campus in the case of an equipment or infrastructure failure in the district heating system.

In remote locations where availability of maintenance personnel is limited and spare parts may need to be delivered by air, the building systems should be designed with as little complexity as possible and a supply of spare parts should be stored on site.

Glycol should be used as the heating system fluid in hydronic systems to prevent freezing and the derate in performance should be accounted for when sizing terminal units.

Freeze protection best practices for plumbing piping should be implemented such as locating piping in interior walls or plumbing chases. Placement of pipes in exterior walls should be avoided.

Implementation of the strategies outlined in this chapter will improve building resilience, which in turn protects the infrastructure and contents of these facilities. Frozen pipes and damage to contents can be extremely costly and, in some cases, can cause irreparable damage to the programming activities housed in the building. It is the responsibility of the designer in partnership with the owner to identify the sensitivity of the facility and to build in resiliency features appropriate to the level of risk that is acceptable while still managing project costs. This may result in a shifting of priorities from other features to cover resiliency measures if the level of risk tolerance for the owner is low.

CHAPTER 7. DISTRICT HEATING SYSTEMS

District energy systems refer to the pipeline infrastructure used for distributing either heating or cooling from centralized energy sources to the end users. District energy systems produce and deliver steam, hot water, or chilled water through piping networks, either under- or above-ground, to buildings in a given area. By combining individual user thermal loads, district energy systems can deliver energy services in a more efficient, economic, and environmentally friendly manner than individual building solutions.

District heating systems have been applied since 1880 and have undergone significant development, evolving from open loop steam supply systems towards closed loop pressurized hot water supply systems, with temperatures as low as 122 °F (50 °C) supply and 90 °F (32 °C) return temperature. The development of the infrastructure has been driven by economics in the past and environmental concerns in the recent years. Today district heating is widely applied in Europe, Russia, China as well as some major cities in the United States.

District cooling is gaining momentum in all markets due to generally increased cooling demands all around the globe. The strategies in this chapter apply to both district heating and cooling systems.

7.1 System design and operation

The first consideration when planning district heating systems is mapping of heat sources, heat demands, location of critical consumers and critical limitations to the distribution pipeline layout. Critical limitations can be railroads or highways that the pipeline is crossing. With that information, it is possible to plan the location of the heat plants (base and peak load) and layout of the distribution pipeline. To maximize heat supply security to critical buildings, it is possible to both locate peak/backup thermal plants at their premises and apply dual supply lines, coming from different parts of the distribution network. For exceptionally temperature sensitive buildings, a thermal storage tank can be located next to the peak/backup thermal plant to maintain stable supply until the boiler is warmed up and in operation. For other buildings, supply security is maximized by distributing the heat plants around the system and by applying loop connections in the network.

7.2 Thermal supply flexibility

District energy systems can provide superior flexibility compared to building-level solutions. A change in buildings' thermal demand can normally be absorbed by the existing system's thermal capacity, and at peak load periods, by using backup thermal generators. Fuel disruptions can be split into short- and long-term disruptions. The impact of short-term fuel disruptions is minimized by using thermal storage systems. To minimize the impact of long-term fuel disruptions, the thermal plants should be designed for operation using multiple fuels. Use of local renewable energy sources will further limit the impact of fuel disruptions. During cold spells or heat waves, district energy systems generally have the flexibility to go beyond design conditions by using spare capacity from backup thermal plants, by pre-charging thermal storage systems, and by changing distribution operation parameters like supply temperature and flow velocities. During emergency response measures, capacity limitations could be implemented for non-critical buildings.

7.3 Resilience enhancing operation

As with all systems, it is critical to ensure that the system is well maintained. For complicated systems with long lifetimes, as are district heating systems, it is important to implement appropriate operation and maintenance procedures from the time the system is commissioned.

History has shown that trivial things as documenting the exact location, types, and ages of pipes along the distribution lines are sometimes neglected. This negligence can have serious implications in the event of disruptions decades into the operation, as it can delay identification of failure point and materials needed for repair.

7.4 Continuous system surveillance

Various measures can ensure system stability and early fault detection. The first priority is to prevent faults, the second priority is to detect faults early, and the third priority is to schedule the emergency operation and maintenance at times that accommodate minimum supply interruption.

Measures for fault prevention are:

- Ensure high water quality to prevent internal corrosion
- Use pre-insulated pipes with welded muffs and bonded system without expansion joints.
- Ensure outside and inside draining and ventilation of underground construction.
- Ensure pressure and temperature levels are within parameters.
- Avoid thermal strain on pipes from too fast supply temperature changes.
- Inspect periodically and exchange critical components before they fail.
- Monitor for unwanted behavior, such as pressure and temperature oscillations.

Measures for early detection include:

- Leakage detection wires in pipe insulation
- Periodic visual inspections of accessible equipment
- Thermal imaging the pipeline from air, thermographic inspection
- Continuous parameter analysis on available data
- Test operability of critical components periodically, such as shutoff valve and backup units.

Many faults occur gradually; with surveillance systems in place it is possible to detect and locate failing pipes or components before they collapse. A SCADA system, which monitors vital parameters and offers remote operation of components, allows the system operator to react more quickly to unforeseen disruptions. Scheduling preventive and non-critical repairs at periods of low heat demand minimizes the impact to consumers.

The system should be designed with redundancy of critical components. An example of this is N+1 design for distribution pumps and heat exchangers. This approach makes it possible to take one of the distribution pumps or heat exchangers offline for maintenance without impacting system operation.

7.5 Thermal generation and supply

District energy systems rely on the setup of thermal generation plants to cope with potential disturbances. The thermal generation system needs to adapt to large variations in thermal demand

over time. For this reason, the system typically relies on multiple generation units. To avoid site-specific disruptions, the generation units should be distributed around the distribution system to minimize the likelihood of total supply failures. If a single generation plant fails, the supply is maintained by operating reserve and peak load boilers or by using portable emergency boilers.

An important parameter to maximize the security of the supply is the location of the thermal generation plants, both base- and peak-load plants. Large base-load plants may have restrictions on locations, due to fuel deliveries, noise, and air pollution. The location of peak and reserve boilers, which have limited operating hours annually, is generally more relaxed and should be determined to maximize overall supply security or alternatively, to maintain energy supply near critical building complexes.

Thermal generation units' thermal storage systems can be used to increase short-term supply security. In areas with large seasonal access to renewable energy, large thermal storage systems can be used to store heat between seasons. Although thermal storage systems are commonly found next to the thermal plants, they can be located strategically along the distribution grid to increase the supply security.

Because district heating is a basic infrastructure that supplies a large number of buildings, it is generally recommended that district heating utilities own and operate their own emergency power generators to ensure operability in case of power grid failure. The emergency power generators should have the capacity to maintain the heat plant operation and the district heating distribution pumps.

7.6 Emergency generation

7.6.1 Mobile boilers

It is common practice for utilities to own or rent portable emergency boilers. Emergency boilers can be housed in containers on trailers (Figure 7-1), or can consist of smaller boilers that can be installed at buildings or at strategic points in the network for use in case of emergency. Mobile boilers consist of a boiler, burners, control equipment (continuously adjustable), all safety devices, pumps, and heating oil tank (natural or liquefied petroleum gas). Similarly to way emergency power generators are provided, connections for mobile boiler plants can easily be provided in the mechanical areas of critical facilities to allow the use of steam or hot water mobile boiler plants to back up utility heat sources or building site boiler(s). This strategy would require a small additional capital investment of limited piping and valves but would require additional level of effort to operate in a contingency (finding/storing available boilers, connecting them to the system, etc.). Using mobile boilers may require running several connections to an external wall, e.g., steam or hot water supply line; fuel line (natural gas or oil) unless the mobile boiler has its own fuel tank; make-up water line, condensate/hot water return line, power (panel box) for external hook up, blow down or drain line, etc.

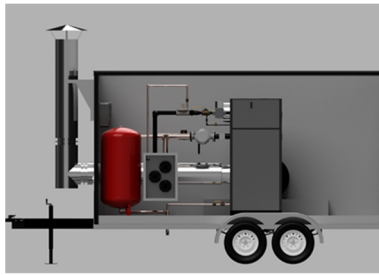

a

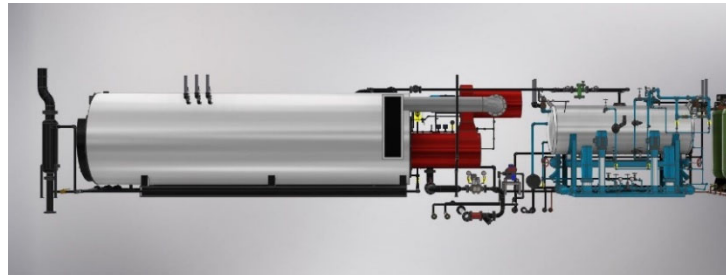

b

Figure 7-1. Mobile boiler: (a) schematic of hot water mobile boiler, (b) schematic of steam mobile boiler (Taylor 2020).

7.6.2 Emergency electrical heating element

As another option, emergency electric heating elements (Figure 7-2) can be installed in the HVAC system to provide supplemental heat (1st stage) by itself, without the use of heat from the main source, e.g., boiler or district heat (2nd stage heat). It is connected to emergency power supply and only used in emergency situations and covers the minimum mission critical load when there is something wrong with the first-stage heating to keep space temperature above minimum requirement to space habitability or prevent building water pipes from freezing (Zhivov 2021b). Great care is to be used when designing the electrical power source so as to not allow use during nonemergency or testing conditions, resulting in significant impacts to the electrical utility bill. If a standby generator is not available onsite to energize the coil(s), then external connections for a portable generator may be desired.

A design impact of this approach is the increased pressure drop and therefore increased energy use of the HVAC system as a result of the coil in the air stream. Equipment should be sized to accommodate both the primary and backup coils unless a bypass is provided that will require additional controls and footprint to reroute flow to the backup system.

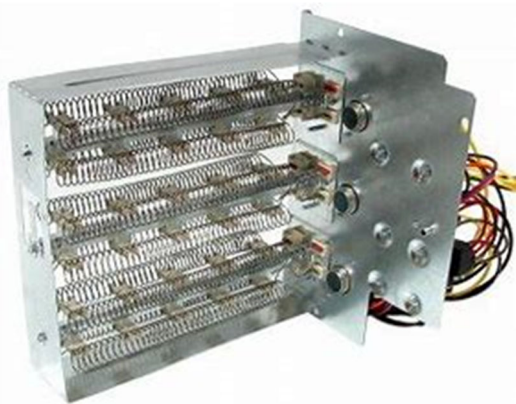

Source: <https://www.warrenhvac.com/>

Figure 7-2. Example of emergency electrical heating element.

7.7 Combined heat and power

The district energy systems allow the use of waste heat from thermal power plants, which otherwise would be wasted to the ambient. Thermal power plants typically have power efficiency of 30%-50%, depending on the type of fuels used, meaning 50%-70% of the input energy is lost to the surroundings. By combining thermal power generation with modern district energy systems and flue gas condensation, it is possible to use the waste heat from the power generation and achieve above 90% fuel efficiency (IEA 2018). The waste heat can be used for heating purposes or as an input energy in absorption cooling machines.

The side effect of extracting heat from power plants is that the power output will drop as heat is extracted. The relation between power generation and heat extraction can be shown using iron diagrams, see Figure 7-3.

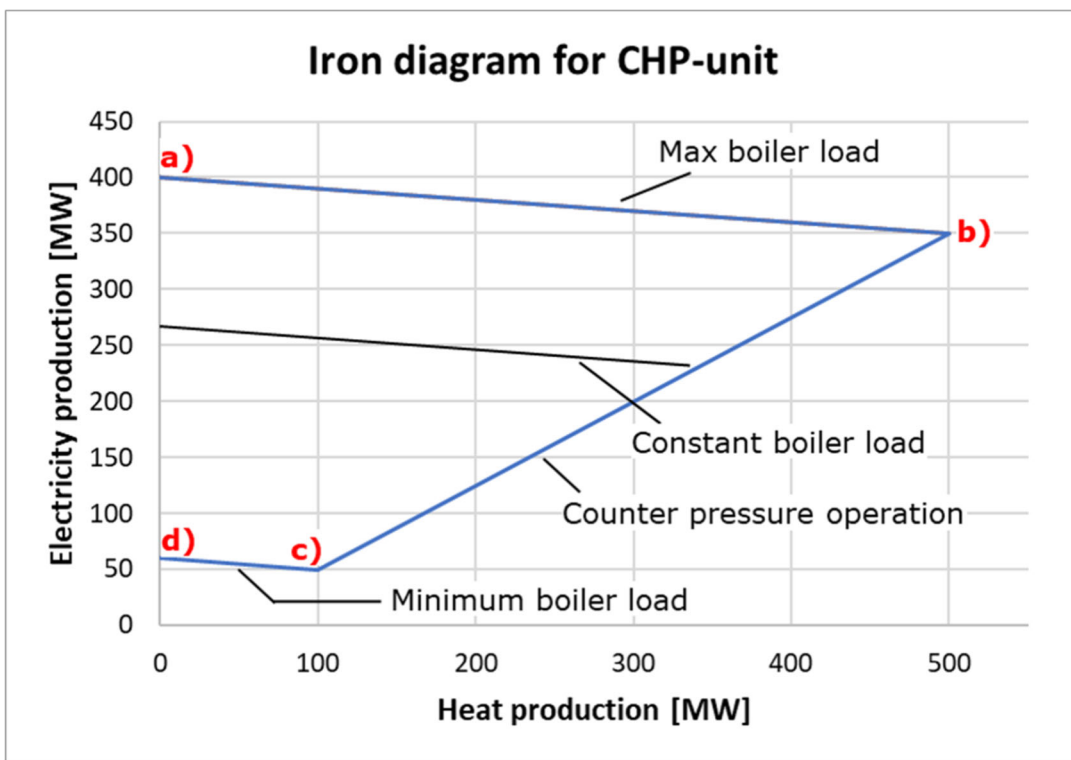

Figure 7-3. Iron diagram for modeling of an extraction condensing unit. The vertical axis indicates the power output and the horizontal axis the heat output.

While going from point a) to b), more heat is being extracted (at max fuel load), which impacts the power output from the plant. The impact comes from the fact that, to get high amount of heat, it is necessary to extract the steam at higher temperature levels, which reduces the power generation potential.











































While going from point b) to c) the boiler load is reduced (less fuel is fed to the boiler) at the same time as maximum heat output is maintained. The line d) to c) further represents the minimum load the boiler can be operated at.

The slope of the line a) to b) indicates the trade-off between power and heat, which is independent of the boiler load.

7.7.1 Combined heat and power (CHP) resilient design

Though district energy systems aggregate thermal loads of multiple customers, they cannot always provide electricity to the same customers because of utility franchise laws. District energy systems are not always integrated with CHP systems; however, combining district energy with a CHP system can be a unique opportunity to provide both thermal energy and electrical power, thereby serving multiple energy needs at once.

CHP can effectively contribute to state and local planning efforts to build resiliency for both critical infrastructure and other facilities, including multi-family housing (Figure 7-4). CHP systems allow facilities to remain functional in the event of a disaster, and for non-critical loads to resume functionality as quickly as possible.

Natural Disaster or Storm Events	Flooding	High Winds	Earthquakes	Wildfires	Snow/Ice	Extreme Temperature
						
Battery Storage						
Biomass/Biogas CHP						
Distributed Solar						
Distributed Wind						
Natural Gas CHP						
Standby Generators						

¹ National Oceanic and Atmospheric Administration, Climate. January 8, 2018. "2017 U.S. billion-dollar weather and climate disasters: a historic year in context." Available at <https://www.climate.gov/news-features/blogs/beyond-data/2017-us-billion-dollar-weather-and-climate-disasters-historic-year>

² The National Association of Regulatory Utility Commissioners (NARUC). *Distributed Energy Resources and Rate Design and Compensation*. Available at <https://pubs.naruc.org/pub/19FDF48B-AA57-5160-DBA1-BE2E9C2F7EA0>

Ranking Criteria

Four basic criteria were used to estimate the vulnerability of a resource during each type of disaster event. They include the likelihood of experiencing:

1. a fuel supply interruption,
2. damage to equipment,
3. performance limitations, or
4. a planned or forced shutdown

 indicates the resource is unlikely to experience any impacts

 indicates the resource is likely to experience one, two, or three impacts

 indicates the resource is likely to experience all four impacts

Source: USDOE (2018).

Figure 7-4. Matrix of DER vulnerability to weather events.

7.7.2 Prioritizing CHP applications

In considering how to incorporate CHP applications, it is recommended to review the U.S. Department of Homeland Security's National Infrastructure and Protection Plan (NIPP) (DHS 2018), which provides emergency planners with a variety of assessment tools. In 2009, the New York State Energy Research and Development Authority (NYSERDA) conducted an assessment with the assistance of the NIPP and found that the most appropriate focus and prioritization of CHP should be at hospitals and water treatment/sanitary facilities, followed by nursing homes, prisons, and places of refuge (Energetics Inc. 2009).

In a current funding solicitation, NYSERDA specified a preference for CHP systems that can run during grid outages to provide electric power to the site's priority loads for all facilities, and not just critical facilities (NYSERDA 2019).

7.8 Distribution network

The purpose of the distribution network is to connect the heat consumers to the heat suppliers. Apart from few infrequently used shutoff valves it is a static infrastructure consisting of insulated pipes with no moving parts. With thoughtful design and careful installation, the pipeline can be in operation for decades with minimal interference.

Where possible it is recommended to place the distribution network in an underground infrastructure, which would avoid many potential above-ground specific disruptions, including natural causes (storms, floods, severe cold, fires, falling trees, etc.) and such human causes as vehicle collisions.

To ensure a long lasting and robust pipeline, it is important to adhere to the pipeline design and installation guidelines from the pipe manufacturers. This minimizes weak points, which can lead to premature pipeline failure. One of the most important parts during installation is to minimize pipe stress from expansion once the system is put in operation. There are different methods available to address pipe expansion such as bends, loops, compensators and preheating/prestressing during installation. For directly buried underground installation the most effective measure is preheating the pipeline to the average operational temperature during backfilling the trenches. The preheating minimizes the stress build up between the pipe and the soil and potential deformation due to elongation once the pipeline goes into operation. The higher the operational temperatures are the more important stress containment becomes.

7.8.1 Meshed network layout and pump strategy

The impact of pipeline disruptions can be reduced by the design of the distribution layout. A meshed or looped layout is preferred over branched layouts. In a meshed layout, there can be multiple supply paths from the heat source to the individual branches. An example of a close to fully meshed layout would be the road network in a city center, where one can take multiple paths between points A and B. Due to practicalities, district energy systems are generally designed with loops in the main distribution pipeline (Figure 7-5).

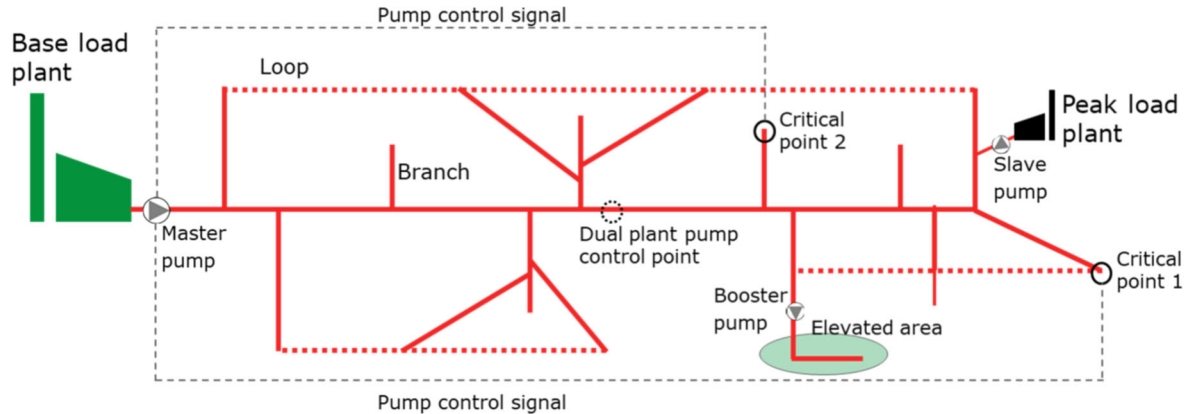

Figure 7-5. Example of meshed network layout structures for district energy system. The dotted red lines represent the transformation from a branch to a meshed system type. The dotted black lines represent the pump control signal.

If a pipeline failure occurs within a loop, the failure can be isolated using nearby shutoff valves and heat delivered through alternative flow paths on both sides of the failure. Buildings within the faulty section, isolated from the heat supply by shutoff valves or in case of a failure at a branch, would need to be addressed with emergency portable boilers or building-level solutions. Figure 7-5 further shows that, by locating the peak load plant at a location different from the base load plant, heat supply can be guaranteed even in case of total failure of the base load plant site. Locating the peak load plant out of the distribution network further reduces system operating pressure demands and consequently the strain on the pipeline.

An important way to limit the system strain is to minimize the required pump head. In general, the pumps feeding the system should be operated to guarantee the minimal differential pressure to operate the building substations at the critical points in the network. During periods where peak load plants are in operation, the pressure level of the system can be minimized by decentralizing the peak load boilers. When there are two or more plants feeding the distribution network the pumps are operated in a master and slave setting, where the operation is to ensure predefined differential pressure at specified points in the network. Further head reduction methods can include the use of booster pumps to overcome site specific situations, e.g., in front of an elevated section of the network or at other strategic locations in the network to reduce the pressure level early in the system.

7.8.2 Strategic location of shutoff valves

Despite careful planning and maintenance, failure can occur, and the impact of the failure should be contained to a reasonable level. Shutoff valves build in the possibility to contain the impact of unexpected pipeline failures to as small section of the network as feasible. Due to the vast variations of distribution systems, there are no specific guidelines on where or how frequently shutoff valves are installed; instead, they are installed strategically for each network. Shutoff valves can be installed to increase the ability to isolate critical consumer groups or vulnerable sections of the pipeline, or to respond to some other case-specific need. The network could be split up in multiple independent systems using shutoff valves and operated in island modes. When considering the shutoff valve strategy, it is important to consider that typically pipeline failures occur gradually and are usually detected well before total failures occur. Figure 7-6 shows ball and butterfly valves; both these types can be controlled either manually or electronically.



Figure 7-6. Left: Example of ball valves in various sizes. Middle: Butterfly valve. Right: Shutoff valves installed in a pipeline. Source: Danfoss A/S.

7.9 Utilization of fault detection equipment and preventive maintenance

It is important to consider what fault detection measures are to be used during the design of the network, as some cannot be retrofitted. By detecting faults before the point of collapse, maintenance can be scheduled and disruptions in the heat supply can be minimized. Although unexpected failures can occur, early warning signs typically indicate problems such as the amount of water loss or make-up water added to the system. Water loss generally occurs through either leaking pipes, components, or refilling after maintenance. For new systems, it is normal to have system water loss of 0.5-2 times the total pipe volume per year, where the majority is due to refilling of pipe sections after pipeline extension or maintenance. As water leakages have a square root relationship with the pressure level, it is possible to determine if there is a stable or deteriorating condition. If the water leakage has reached unacceptable levels, the traditional method of locating the leakage is by tracing the surface where the distribution pipeline is buried and looking for hot spots using thermal cameras. In new systems, leakage detection wires are installed in the insulation of the pre-insulated pipes (see Figure 7-7); Pipe leakage or external water infusion will cause a short circuit between the wires so the leakage detection system will locate the potential leak and inform the utility.



Figure 7-7. Leakage detection wires in a pre-insulated single and twin pipe. Source: Løgstør A/S.

The lifetime of pipes and components can be based on number of pressure cycles or periods of operation with high temperature levels. Reliability testing and scheduled replacement of pipes and components can minimize the impact of disruptions. Scheduled replacement should be balanced against the economic optimal replacement. Vital components that are difficult to replace during operation could be replaced on a schedule; non-critical components can remain as long as they are functional, or they can be replaced at a time when the maintenance does not interfere with system operation.

7.10 District energy interface units

The purpose of the building interface is to regulate the thermal energy exchange with the building. There are two basic principles of building interface units: direct and indirect connection to the district energy system. Both principles have benefits as well as limitations.

An indirectly connected interface has a heat exchanger that hydraulically separates the district heating system from the building heating installation (see Figure 7-8).

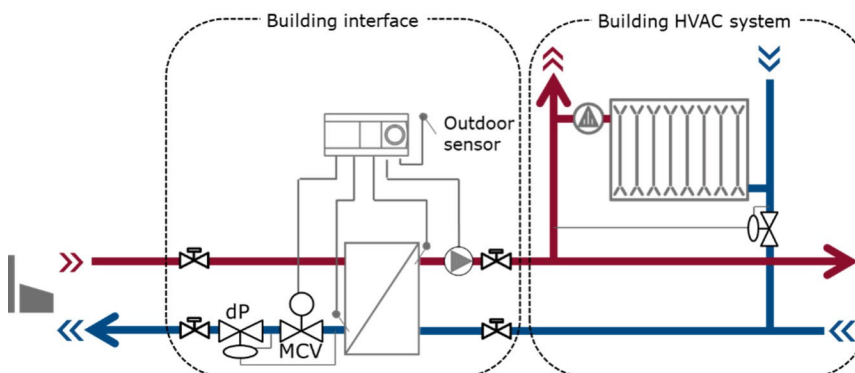

Figure 7-8. Schematics of indirect district energy interface. Source: Danfoss A/S.

The benefits of an indirect heating system are:

- Impurities originating either in the district heating or the building heating installation will be isolated to that respective system.

- The heat exchanger will act as a pressure breaker if pressure surges occur in the district heating system and effectively protect the building heating installation.
- The system is highly flexible in accommodating district heating pressure levels.
- The system reduces the impact of leakage in the building heating installation, i.e., leakage is limited to the building heating installation volume.

The main limitation is that the system cannot guarantee full heat supply when there are power disruptions to the building.

A direct connected interface refers to that the district energy water is supplied directly into the building heating installation. It is recommended that direct connected interfaces have temperature regulation via mixing loop (see Figure 7-9). The mixing loop adapts the heat supply parameters, temperature, and differential pressure to the actual demand of the building, which ensures stable operating conditions, good indoor climate, and energy savings.

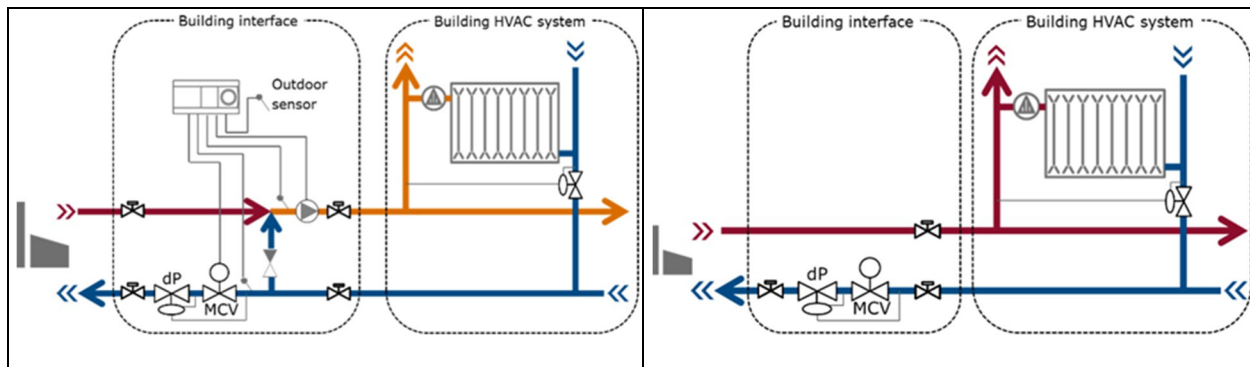

Figure 7-9. Schematics of direct building district energy interfaces with mixing loop to left and without mixing loop to right. Source: Danfoss A/S.

The main benefits of a direct connected interface it can maintain a heat supply even during a total power failure, provided the district heating utility is operational.

The main limitations of direct connection building interfaces are:

- In case of a distribution grid failure the building installation can lose water, which may cause problems if a portable emergency boiler is connected to the building.
- Impurities originating in the building heating installation will flow freely to the district heating system and can contaminate the district heating water and effectively spread to all connected buildings.
- Pressure surges in the distribution network, which may occur in case of disruptions, will penetrate the building installations and can result in damaged installations.

7.11 Case studies

7.11.1 Sønderborg, Denmark

The small city of Sønderborg, with a population of 28,000, has an extensive district heating system covering above 95% of the city heat demand (see Figure 7-10). This multi-fuel, multi-heat source system has a total installed capacity of 200 MW and heat delivery of 290 GWh/year. In 2018, 41% of the heat came from waste incineration, 49% from the biomass plant, and 10% from other sources. The heat supply units include waste incineration, biomass boiler, heat

pumps, and a deep geothermal plant. Additionally, it operates multiple peak boilers distributed around the system as well as a large trailer based portable boiler (see Figure 7-11). The distribution networks extends above 320 km and has a meshed design, which greatly limits the impact from pipeline disruptions. Sønderborg district heating further supplies heat to the regional hospital, which has its own emergency CHP plant that also functions as a reserve heat supply for the district heating network.



Figure 7-10. Sønderborg district heating system. The base load plant is a waste incineration CHP with a large thermal storage.



Figure 7-11. Portable emergency boiler in the Sønderborg district heating system.

7.11.2 Quaanaaq in Greenland

The importance of resilience depends on locations and function of each site. In remote arctic regions, disconnected from electric and gas grids and devoid of local resources, the challenge of resilient solutions and efficient use of resources and opportunities is obvious. This is the case in Quaanaaq, the home to 656 people and the U.S. Thule Air Base (Figure 7-12).

Quaanaaq was established in 1952 to host the native population and the Thule Air Base. The settlements' infrastructure was planned as a campus design, which offered good opportunity to optimize the infrastructure and take advantage of synergies and symbiotic potentials of different systems. A resilient energy system and energy efficiency are key parameters to the survivability of the settlement. The North Star Bay, where Quaanaaq resides, is ice locked 9 months a year.

To ensure the operational effectiveness of the air base and livable environment for the local population, the energy infrastructure must be operational at all times and must operate at maximum fuel efficiency to minimize the cost of fuel import and risk of fuel shortages due to long severe winter storms and extreme cold. As an indication of the local weather, the U.S. Air Force Thule welcome package document (Chickery 2017) informs newcomers that storm class Alpha (initial warning of a potential arctic winter storm within 12 hours) imposes no restrictions to normal activities, and that Thule experiences only two seasons, light and dark.



Figure 7-12. The urban settlement in Quaanaaq, Greenland. Source: Ramboll A/S.

The key technology to fulfill resilience requirements of the main infrastructure of Quaanaaq is the district heating system. The district heating system uses the waste heat from the three diesel power generators, which provide 1,436 kW power and 2.5 MW thermal capacity at normal operating conditions. Additionally, there are three peak load heat only boilers with capacity of 1.5 MW and two emergency power generators of 600 kW. The annual heat and power demands are 5,230 MWh and 2,750 MWh, respectively. The combined heating and power system has a fuel efficiency of 80-85% (low calorific value [LCV]) as end-use measured per fuel consumption. In case of power only generation and building heat only boilers, the combined efficiency would be only 55%.

Due to the arctic climate and permafrost the district heating, and other infrastructure, is kept above ground in ducts (Figure 7-13). Here the relatively low heat loss of 15% from the district heating distribution system provides frost protection service to other infrastructure, waste water pipes, and fresh water pipes. The ducts and the heat loss further contribute to safer walking paths within the community than would otherwise be possible.



Figure 7-13. Above-ground supply infrastructure. Source: Ramboll A/S.

The infrastructure in Quaanaaq, Thule, demonstrates that it is possible to plan and operate efficient and resilient energy services in symbiosis with water and waste water in the Arctic; however, it has also shown that it can be difficult to keep and attract qualified staff to ensure efficient operation and a high maintenance standard.

7.12 Conclusions

Decades of operation of many thousands of district heating systems in multiple countries around the world, which experience all varieties of climate conditions, is a testimony to the resilience of the infrastructure. Modern district heating systems have an exceptionally high service reliability, i.e., above 99.999% reliability (Markham District Energy 2020, Ontiveros 2018). They are designed and built to withstand disruptions by using multiple heat sources that are often distributed around the geographical area of the system, and meshed pipeline layouts. In the event of catastrophic failures, portable emergency boilers can be used to supply parts of the system or critical buildings.

The key elements to realizing a resilient district heating system are:

- Design, install and operate the pipeline and other components according to recommendation from the manufacturers.
- Design the distribution system with a meshed structure (loops).
- Apply multiple and distributed heat sources along the distribution network.
- Use local energy sources to minimize impact of fuel shortages.
- Apply thermal storage systems to reduce supply risk in events of short to medium-term plant disruptions.

- Apply leakage detection methods to find pipeline failures before they become critical.
- Perform periodic visual and operational inspection of components.
- Schedule maintenance at times when minimum heat consumer impact occurs.

The increased focus on renewable energy, along with the maximum use of primary energy sources will drive the development of district heating systems characterized by even more reliable and resilient operation. District heating utilities can facilitate this development by working towards lower operating temperatures both within the utilities' and their customers' heating systems. Low temperature supply systems allow significantly more cost-efficient exploitation of local renewable and waste heat power sources.

CHPs enable maximum fuel efficiency, which reduces the amount of fuel that must be regularly delivered or stored in response to security restrictions or natural delivery barriers (e.g., due to ice-blocked access that may occur during winter periods in polar regions).

CHAPTER 8. EVALUATION MAXIMUM TIME TO REPAIR

Oberg et al. (2021) conducted one of the first-of-its-kind thermal decay study that attempted to address thermal decay in cold environments at two installations in Alaska. These tests, which were conducted with outside air temperatures ranging between -20 °F and -40 °F (-28.9 °C and -40 °C), allowed researchers to obtain the building-specific data on temperature change in different building areas and different surfaces of tested buildings to identify critical areas with significant temperature degradation compared to other building areas.

Based on these tests, air temperature in mechanical rooms located in the basement, in a semi-basement, or on a first floor with opening(s) for make-up air or fenestration, or with a large open stairway column located nearby, was found to deteriorate more quickly than in other parts of the building; therefore, mechanical rooms can be used as representative locations for identifying the time when a building reaches sustainability thresholds. Typically, the longest time to reach the habitability threshold occurs on the middle floors, which can be recommended as locations to host mission critical operations (and which therefore have been used as representative locations for this purpose). This study used EnergyPlus-based building energy modeling along with weather data corresponding to the test locations and dates, which allowed the building models to be calibrated for use in parametric studies of representative buildings.

The parametric studies of indoor air temperature decay (Liesen et al. 2021) was conducted using geometry of one of the studied buildings (Figure 8-1) The building has two floors and a basement and houses office and meeting spaces, medical examination facilities, and medical laboratories.

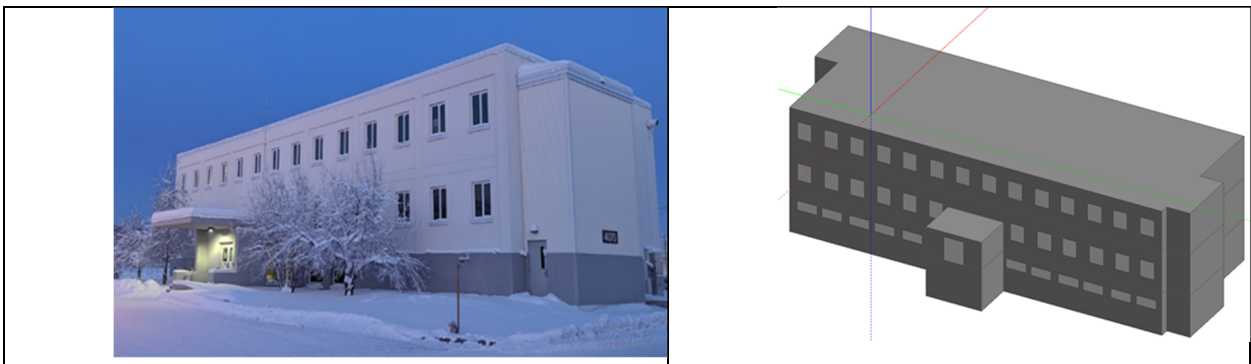

Figure 8-1. Studied building photo and model representation.

The following parameters have been changed in the study:

- **Building mass:** (1) high mass building (CMU and poured concrete slabs) and (2) light-frame buildings;
- **Thermal envelope characteristics:** ranging from (1) pre-1980 code construction, (2) current minimum energy efficiency requirements (lower efficiency), and (3) state-of-the-art energy efficient building characteristics (high efficiency), for the buildings constructed in the DOE Climate Zone 8. Table 8-1 lists specific characteristics for these three building categories.
- **Outside dry bulb air temperature (ODB):** -60 °F, -40 °F, -20 °F, 0 °F, 20 °F, and 40 °F (-51 °C, -40 °C, -29 °C, -18 °C, -6.6 °C, and 4.4 °C). TMY3 weather files used in the parametric study have been adjusted to a steady state temperature file.

Table 8-1. Parametric study results for the maximum allowable time to repair.

Building Parameters	Temp ODB	Mass Building			Frame Building		
		Typical/ Post 1980	Low Efficiency	High Efficiency	Typical/ Post 1980	Low Efficiency	High Efficiency
Walls (R-value, F·ft ² ·hr/Btu)		20.5	40	50	20.5	40	50
Roof (R-value, F·ft ² ·hr/Btu)		31.5	45	60	31.5	45	60
Air Leakage (cfm/ft ² at 75Pa)		0.4	0.25	0.15	0.4	0.25	0.15
Window (R-value), F·ft ² ·hr/Btu, U-value, W/(m ² ·K)		Double Pane; R= 1.78 / U=0.56	Double Pane; R= 3.34 / U=0.3	Triple Pane; R= 5.25 / U=0.19	Double Pane; R= 1.78 / U=0.56	Double Pane; R= 3.34 / U=0.3	Triple Pane; R= 5.25 / U=0.19
MaxTTR Hab. (60 °F)	-60 °F (-51 °C)	< 1 hour	2 hours	5 hours	<< 1 hour	1 hours	2 hours
MaxTTR Sust. (40 °F)	-60 °F (-51 °C)	9 hours	28 hours	41 hours	4 hours	14 hours	21 hours
MaxTTR Hab. (60 °F)	-40 °F (-40 °C)	1 hour	3 hours	10 hours	< 1 hour	2 hours	4 hours
MaxTTR Sust. (40 °F)	-40 °F (-40 °C)	20 hours	36 hours	51 hours	10 hours	18 hours	24 hours
MaxTTR Hab. (60 °F)	-20 °F (-34 °C)	2 hours	6 hours	15 hours	1 hour	3 hours	6 hours
MaxTTR Sust. (40 °F)	-20 °F (-34 °C)	31 hours	46 hours	60 hours	15 hours	22 hours	28 hours
MaxTTR Hab. (60 °F)	0 °F (-18 °C)	3 hours	13 hours	29 hours	2 hours	5 hours	9 hours
MaxTTR Sust. (40 °F)	0 °F (-18 °C)	43 hours	59 hours	90 hours	21 hours	28 hours	33 hours
MaxTTR Hab. (60 °F)	20 °F (-6.6 °C)	10 hours	28 hours	45 hours	3 hours	8 hours	15 hours
MaxTTR Sust. (40 °F)	20 °F (-6.6 °C)	60 hours	78 hours	95 hours	28 hours	35 hours	40 hours
MaxTTR Hab. (60 °F)	40 °F (4.4 °C)	29 hours	54 hours	72 hours	8 hours	17 hours	23 hours
MaxTTR Sust. (40 °F)	40 °F (4.4 °C)	93 hours	112 hours	123 hours	41 hours	47 hours	50 hours

Results of these studies listed in Table 8-1 clearly show that high building mass contributes significantly to the thermal resilience of the building, along with the higher building air tightness and a higher thermal insulation. Figure 8-2 shows the case of simulated interruption of the mechanical heating supply during outside temperature conditions of -40 °F (-40 °C). In a building with a mass structure (Figure 8-2a) and a more energy efficient building envelope design, the indoor air temperature approached the habitability level of 60 °F (16 °C) 7 hours later than did a similar building with a less energy efficient building envelope, and 6 hours later than did a similarly arranged, framed (i.e., lower thermal mass) building structure (Figure 8-2b). The intersection of the indoor air temperature decay line with the building sustainability threshold of 40 °F (4 °C) occurs 31 and 27 hours later, respectively, for the same scenarios. When mass high-performance buildings are compared to buildings built using pre-1980 code (which

constitute the majority of existing buildings), the difference in the maximum time to repair calculated until the building air temperature reaches habitability and sustainability threshold values, the difference in maximum allowable time to repair is much more significant. Figure 8-3 shows a significant difference in a temperature decay between a mass high-efficiency building and a frame building built to meet current minimum requirements. With the current trends in climate change, similar studies to obtain time until the building air temperature reaches habitability and sustainability threshold values with power supply interruption to HVAC system can be critical for buildings located in hot and humid climates.

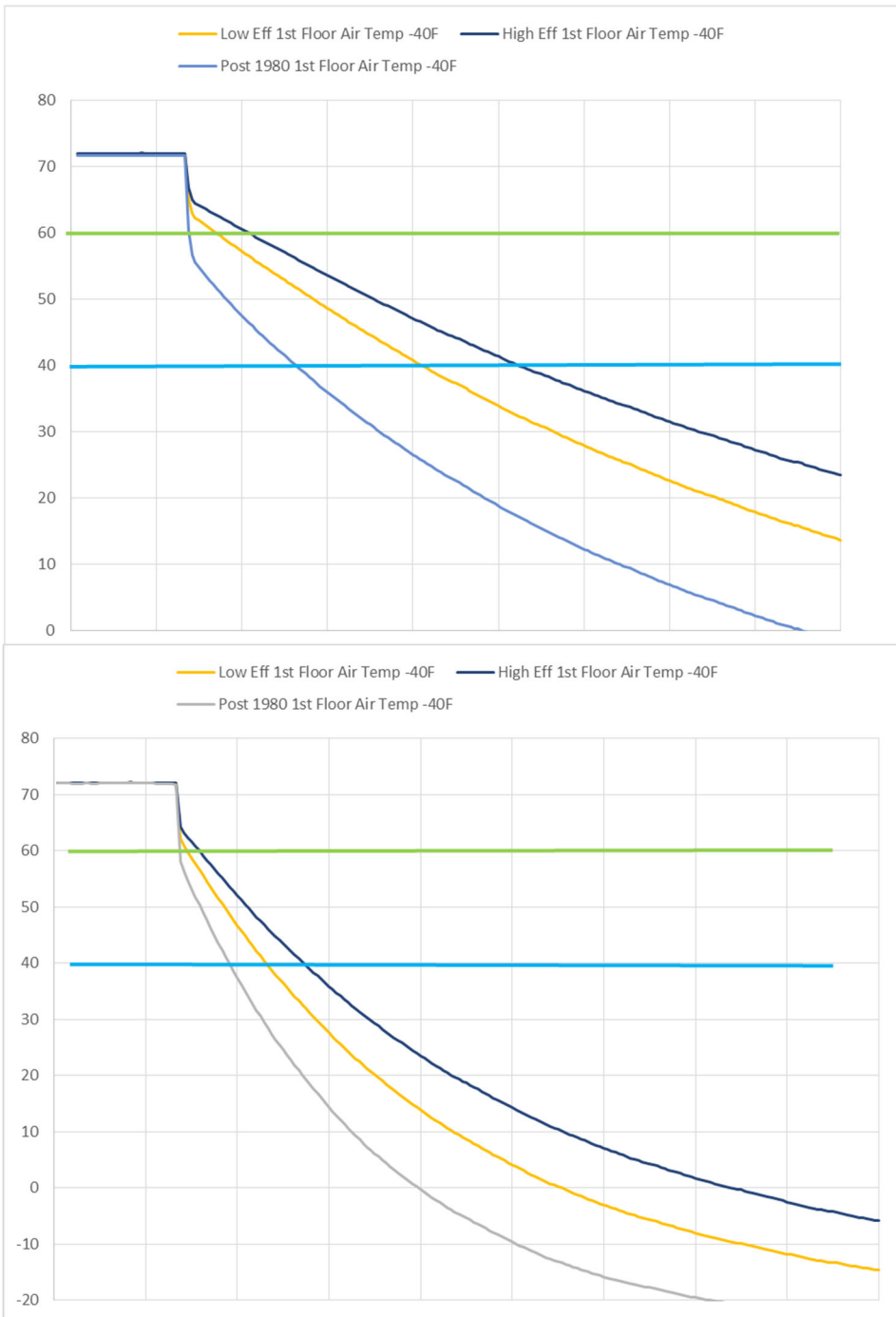

Figure 8-2. Indoor air temperature decay in high efficiency, low efficiency, and post-1980 installation buildings with a heating system failure at outdoor air temperature of -40 °F (-40 °C): a – mass building, b – frame building.

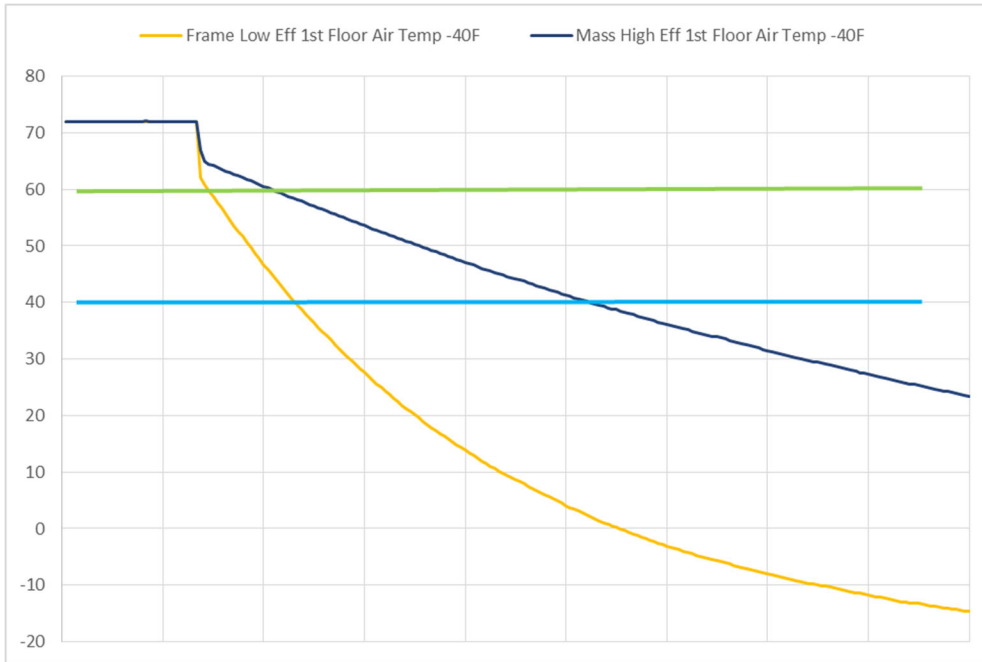

Figure 8-3. Comparison of indoor air temperature decay in low-efficiency frame building vs. high-efficiency mass building with a heating system failure at outdoor air temperature of -40 °F (-40 °C).

REFERENCES

- ACGIH. 2017. *Heat Stress and Strain: TLV(R) Physical Agents*. 7th ed. Cincinnati, OH: ACGIH®.
- ACGIH. 2018. *Cold Stress: TLV(R) Physical Agents*. 7th ed. Cincinnati, OH: ACGIH®.
- Alaska Earthquake Center. 2020. *Why Earthquakes Happen in Alaska*.
<https://earthquake.alaska.edu/earthquakes/about>.
- Alaska Housing Finance Corporation. 2018a. *2018 International Residential Code (IRC) with Alaska-Specific Amendments*. December 10th, 2018.
- Alaska Finance Housing Corporation. 2018b. *Alaska Specific Amendments to IECC 2018*
https://www.ahfc.us/application/files/1815/5191/6053/2018_IECC_Alaska_Specific_Amendments.pdf.
- Anis, W. 2001. "The Impact of Airtightness on System Design." *ASHRAE Journal*. 43:12. Peachtree Corners, GA: ASHRAE.
- ASHRAE. 2009. *Design Considerations for Datacom Equipment Centers*. ASHRAE Datacom Series. Peachtree Corners, GA: ASHRAE.
- ASHRAE. 2019. *Energy Standard for Buildings Except Low-Rise Residential Buildings*. ASHRAE Standard 90.1 Peachtree Corners, GA: ASHRAE.
- ASHRAE. 2017. *Standard for the Design of High-Performance Green Buildings Except Low-Rise Residential Buildings*. ASHRAE Standards 189.1 Peachtree Corners, GA: ASHRAE.
- ASHRAE. 2021. *Cold-Climate Buildings Design Guide, Second Edition*. Peachtree Corners, GA: American Society of Heating, Refrigerating and Air-Conditioning Engineers.
- ASHRAE. 2017. *Thermal Environmental Conditions for Human Occupancy*. ASHRAE Standard 55. Peachtree Corners, GA: ASHRAE.
- ASHRAE. 2017. ASHRAE Standard 170. *Ventilation of Healthcare Facilities*. Peachtree Corners, GA: ASHRAE
- ASHRAE. 2020. "HVAC Applications." ASHRAE Handbook. Peachtree Corners, GA: ASHRAE.
- ASHRAE. 2019. *Ventilation for Acceptable Indoor Air Quality*. ASHRAE Standard 62.1. Peachtree Corners, GA: ASHRAE.
- ASTM (American Society for Testing and Materials). 2010. *Standard Test Method for Determining Air Leakage Rate by Fan Pressurization*. Standard E 779. West Conshohocken, PA: ASTM.
- . 2015. *Standard Practice for Thermographic Inspection of Insulation Installations in Envelope Cavities of Frame Buildings*. Standard C1060 – 11a. West Conshohocken, PA: ASTM.
- . 2017. *Standard Practices for Air Leakage Site Detection in Building Envelopes and Air Barrier Systems*. Standard E1186. West Conshohocken, PA: ASTM.
- . 2019. *ASTM E 2190 Standard Specification for Insulating Glass Unit Performance and Evaluation*. West Conshohocken, PA: ASTM International. www.astm.org.
- Bender, Adrian, USGS, Alaska Science Center. https://prd-wret.s3.us-west-2.amazonaws.com/assets/palladium/production/s3fs-public/styles/full_width/public/thumbnails/image/Alaska_fault_model_10-11-2018_Adrian_Bender_1.png.
<http://www.akhistorycourse.org/images/geography/large/ps9.jpg>.
- Bean, Robert 2006. *Infloor Radiant Design Guide: Heat Loss to Head Loss*.
http://www.healthyheating.com/Radiant_Design_Guide/Infloor_Radiant_Design_Guide.htm
- Bjella, K. 2012a. *Thule Air Base FY12 Dormitory Permafrost and Geotechnical Investigation*. ERDC/CRREL Letter Report LR 12-01. Hanover, NH: Engineer Research and Development Center, Cold Regions Research and Engineering Laboratory (ERDC-CRREL).
- Bjella, K. 2012b. *Thule Air Base Consolidated Facilities Permafrost and Geotechnical Investigation*. ERDC/CRREL Letter Report LR 12-03. Hanover, NH: ERDC-CRREL.

- Bjella, K. 2012c. *Preliminary Permafrost and Hangar Investigation, Naval Arctic Research Lab, Barrow, Alaska*. ERDC/CRREL Technical Report TR 12-05. Hanover, NH: ERDC-CRREL.
- Bjella, K., Weale, J., Lawson, D. 2013. *A Synopsis of Arctic Permafrost and Permafrost Engineering Knowledge*. A Report to the U.S. Department of Defense's European Command.
- Chickery, Garry S., Jr. 2017. *Welcome to Thule "The Top of the World."* <https://www.peterson.af.mil/Portals/15/documents/Units/THULE-Welcome%20Package%202017.pdf?ver=2017-06-06-095031-607>.
- Bygningsreglement. 2006. (Greenlandic Building Regulations. 2006.) Directorate for Housing and Infrastructure.
- Craven, C., and R. Garber-Slaght. 2012. "Exterior Insulation Envelope Retrofits in Sub-Arctic Environments." Seventh International Cold Climate HVAC Conference. Peachtree Corners, GA: ASHRAE.
- Danish Energy Agency. 2020. *Technology Data Catalogue for Electricity and district heating production – Updated April 2020*. Copenhagen, Denmark: Danish Energy Agency.
- Decree of the Finnish Ministry of the Environment on the Energy Performance of New Buildings (1010/2017).
- DHS (U.S. Department of Homeland Security). 2018. *National Infrastructure Protection Plan/* Washington, DC: DHS.
- DoD (U.S. Department of Defense). 2020. DoD Memorandum. Subject: Metrics and Standards for Energy Resilience at Military Installations. Metrics and Standards for Assessment of Energy Resilience, Supporting Policy and Guidance and Associated Reporting Requirements.
- Energetics Inc. 2009. *The Contribution of CHP to Infrastructure Resiliency in New York State*. New York: New York State Energy Research and Development Authority.
- England's H.M. Government Non-Dwelling Building Code Regulation, 2010-16 L2a
- ERDC. 2020. "Thermal Energy Systems Resilience in Cold/Arctic Climates." Materials of the Consultation Forum. Fairbanks, AK: Engineer Research and Development Center, Construction Engineering Research Laboratory (ERDC-CERL). <http://wiki.cchrc.org>.
- FEMA (Federal Emergency Management Agency). 2008. *Wildfire Hazard Mitigation Handbook for Public Facilities*. FEMA P-754. <https://www.wbdg.org/FFC/DHS/femap754.pdf>.
- Finnish Ministry of the Environment. 2017. *Decree of the Finnish Ministry of the Environment on the Energy Performance of New Buildings (1010/2017)*.
- Greenlandic Building Regulations (Bygningsreglement). 2006. Directorate for Housing and Infrastructure.
- Gudmundsson, Oddgeir, Jan Eric Thorsen and Anders Dyrelund. 2020. "Thermal Energy Systems Resilience in Cold/Arctic Climates." *District Energy – The Resilient Energy Infrastructure. Materials of the Consultation Forum*. Fairbanks, AK: Engineer Research and Development Center, Construction Engineering Research Laboratory (ERDC-CERL).
- HQDA (Headquarters, Department of the Army). 2015. *Energy Security and Sustainability (ES2) Strategy*. Washington, DC: HQDA.
- HQUSACE (Headquarters, U.S. Army Corps of Engineers). 2009. Engineering and Construction Bulletin (ECB) No. 2009-29. Subject: Building Air Tightness Requirements. https://wbdg.org/FFC/ARMYCOE/COEECB/ARCHIVES/ecb_2009_29.pdf
- . 2004 (Inactive). *Foundations for Structures: Arctic and Subarctic Construction*. Unified Facilities Criteria (UFC) 3-130-04. Washington, DC: USACE (preparing agency), Naval Facilities Engineering Command (NAVFAC), and Air Force Civil Engineer Support Agency (AFCESA). https://www.wbdg.org/FFC/DOD/UFC/INACTIVE/ufc_3_130_04_2004.pdf.
- . 2011 (Rev. 2019). *Architecture*. UFC 3-101-01. Washington, DC: USACE (preparing agency), Naval Facilities Engineering Command (NAVFAC), and Air Force Civil Engineer Support Agency (AFCESA).

- . 2012. *Air Leakage Test Protocol for Building Envelopes*, Version 3. Champaign, IL: USACE, Engineer Research and Development Center, Construction Engineering Research Laboratory (ERDC-CERL) and Reston, VA: Air Barrier Association of America (ABAA). https://www.wbdg.org/FFC/ARMYCOE/usace_airleakagetestprotocol.pdf.
- IMCOM (U.S. Army Installation Management Command). 2010. *Energy and Water Conservation Design Requirements for Sustainment, Restoration and Modernization (SRM) Projects and MILCON Construction*. Prepared by ERDC-CERL.
- . 2012. ECB No. 2012-16. Subject: Building Air Tightness and Air Barrier Continuity Requirements. https://www.wbdg.org/FFC/ARMYCOE/COEECB/ARCHIVES/ecb_2012_16.pdf
- IEA (International Energy Agency). 2018. "Solar District Heating – Inspiration and Experiences from Denmark." Danish District Heating Association/PlanEnergi. International Energy Agency Solar Heating and Cooling Programme.
- ISO (International Organization for Standardization). 1983. *Qualitative Detection of Thermal Irregularities in Building Envelopes*. ISO 6781-1983-12-15. Geneva, Switzerland: ISO.
- Jacobson, Murray M. 1965. *Materials Engineering for Cold Regions and the Brittle Fracture Problem*. AMRA MS 65-05/D620214. Watertown, MA: U.S. Army Materials Research Agency (AMRA). <https://apps.dtic.mil/sti/pdfs/AD0620214.pdf>.
- Jones, C. 2017. "Flood Resistance of the Building Envelope." *Whole Building Design Guide*. <https://www.wbdg.org/resources/flood-resistance-building-envelope>.
- Kneisel, C., Hauck, C., Fortier, R., & Moorman, B., 2008. "Advances in Geophysical Methods for Permafrost Investigations." *Permafrost and Periglacial Processes* 19(2):157-178.
- Leffel, Emmett. 2021. "Building Enclosure Testing on Alaska Military Base Projects." *ASHRAE Transactions* 127(1).
- Liesen, Richard J., Brianna Morton, Brandy Diggs-McGee, and Alexander M. Zhivov. 2021. "Thermal Energy System Resilience: Thermal Decay Test (TDT) in Cold/Arctic Climates, Part II Modeling." *ASHRAE Transactions* 127(1).
- Løgstør A/S. 2019. *Design Manual*. Løgstør, Denmark: Løgstør AS.
- Markham District Energy. 2020. "Markham District Energy Facts." *Markham District Energy*. Web page. <https://www.markhamdistrictenergy.com>.
- Municipality of Anchorage. 2018. *Development Services, Coded Policies and Handouts*. <https://www.muni.org/departments/ocpd/development-services/codes-handouts/pages/codes.aspx>.
- National Research Council Canada. 2017. *National Energy Code of Canada for Buildings*. Ottawa, Canada: National Research Council Canada.
- NERC (North American Electricity Reliability Council). 2018. Reliability Issues Steering Committee Report on Resilience. https://www.nerc.com/comm/RISC/Related%20Files%20DL/RISC%20Resilience%20Report_Aproved_RISC_Committee_November_8_2018_Board_Accepted.pdf
- New York State Energy Research and Development Authority, *CHP Program*, New York, NY: New York State Energy Research and Development Authority, 2019.
- NIOSH. 2016. *Criteria for a Recommended Standard: Occupational Exposure to Heat and Hot Environments*. DHHS (NIOSH) Publication Number 2016-106. Cincinnati, OH: U.S. Department of Health and Human Services, Centers for Disease Control and Prevention, National Institute for Occupational Safety and Health.
- Norwegian Building Authority. 2017. Regulations on Technical Requirements for Construction Works (Byggteknisk forskrift – TEK17).
- Nygaard, Tamra. 2019. Arctic and Subarctic Thermal Protection Practices: Criteria for MILCON North of the Alaska Range. Thermal Study Report prepared for ERDC-CERL. 22 November 2019.

- Oberg, Bjorn K., Angela Urban, Emmet Leffel, Jonathan Goebel, Matt Perry, Dragos Vas, Dayne Broderson, Richard Liesen, and Alexander Zhivov. 2021. "Thermal Energy System Resilience: Thermal Decay Test (TDT) in Cold/Arctic Climates, Part I Data Collection and Protocol." *ASHRAE Transactions* 127(2).
- Olesen, B.W., Thermal comfort requirements for floors occupied by people with bare feet, *ASHRAE Transactions* No. 2451, 1977, pp. 41–57.
- Ontiveros, J. 2018. *District Energy System*. Austin, TX: The University of Texas at Austin.
- Parsons K. C. 2003. "Thermal Comfort." In K. C. Parsons (ed.), *Human Thermal Environments: the Effects of Hot, Moderate, and Cold Environments on Human Health, Comfort, and Performance*. 2d ed. Taylor & Francis, London, pp. 198-228.
- Potter, N. 1998. *Air Tightness Specifications*. Berkshire, UK: Building Services Research and Information Association (BSRIA).
- RDH. 2016a. Energy Efficient Housing Guidelines for Whitehorse Canada Cost Optimized House.
- RDH. 2016b. Optimal Northern Wall Design Guidelines. Project 8017.3006.
- Sterling, E., A. Arundel, and T. Sterling. 1985. "Criteria for Human Exposure to Humidity in Occupied Buildings." *ASHRAE Transactions* 91(1):611-622.
- White House, The. 2013. *Presidential Policy Directive 21: Critical Infrastructure Security and Resilience*. PPD-21. Washington, DC: The White House.
- Taylor, Steven. 2020. "Thermal Energy Systems Resilience in Cold/Arctic Climates." *District Energy – The Resilient Energy Infrastructure. Materials of the Consultation Forum*. Fairbanks, AK: Engineer Research and Development Center, Construction Engineering Research Laboratory (ERDC-CERL).
- U.S. Climate Resilience Toolkit. 2017. "Arctic Weather and Extreme Events." <https://toolkit.climate.gov/regions/alaska-and-arctic/arctic-weather-and-extreme-events>.
- USDOE (U.S. Department of Energy). 2018. "Distributed Energy Resources Disaster Matrix." *Better Buildings*. Web page. Washington, DC: USDOE. <https://betterbuildingssolutioncenter.energy.gov/resources/distributed-energy-resources-disaster-matrix>.
- Wargocki P., and D. P. Wyon. 2017. "Ten Questions concerning Thermal and Indoor Air Quality on the Performance of Office Work and Schoolwork." *Building and Environment* 112:359-366.
- Wagner, Anna M. "Creation of an artificial frozen barrier using hybrid thermosyphons." *Cold Regions Science and Technology* 96(2013):108-116.
- Winfield, Emily, Robin Rader, Alexander Zhivov, Thomas Adams, Anders Dyrelund, Craig Fredeen, Oddgeir Gudmundsson, and Brent Goering. 2021. "Best Practices for HVAC, Plumbing and Heat Supply in Arctic Climates." *ASHRAE Transactions* 127(1).
- Xu, J., and D. J. Goering. 2008. "Experimental Validation of Passive Permafrost Cooling Systems." *Cold Regions Science and Technology* 53(3):283-297.
- Yarmak, Jr, E., and E. L. Long. 2002. "Recent Developments in Thermosyphon Technology." *Proc. 11th Int'l Conf. On Cold Regions Engineering*, Anchorage, Alaska. Vol. 79.
- Zhivov, A., D. Herron, J. L. Durston, M. Heron, and G. Lea. 2014. "Air Tightness in New and Retrofitted U.S. Army Buildings." *The International Journal of Ventilation*. 12(4). ISSN 1473 – 3315.
- Zhivov, Alexander, Andrew Stringer, Michael Fox, John Benefiel, Patrick Daniels and Todd Tarver. 2021a. "Defining, Measuring and Assigning Resilience Requirements to Electric and Thermal Energy Systems." *ASHRAE Transactions* 127(1).
- Zhivov, Alexander, William Rose, Raymond Patenaude, and William Warren. 2021b. "Requirements for Building Thermal Conditions under Normal and Emergency Operations in Extreme Climates." *ASHRAE Transactions* 127(1).
- Zhivov, A., and R. Lohse. 2020. *Deep Energy Retrofit. A Guide to Achieving Significant Energy Use Reduction with major Renovation Projects*. Annex 61. Springer.

ACRONYMS AND ABBREVIATIONS

Abbreviation	Term
ABAA	Air Barrier Association of America
AFCESA	Air Force Civil Engineer Support Agency
AKST	Alaska Standard Time
ASHRAE	American Society of Heating, Refrigerating and Air-Conditioning Engineers
ASTM	American Society for Testing and Materials
BET	Building Envelope Testing
CFM	Cubic Feet per Minute
CHP	Combined Heat and Power
CMU	Concrete Masonry Unit
DBT	Dry Bulb Temperature
DDC	Direct Digital Control
DER	Deep Energy Retrofit
DoD	Department of Defense
DOE	Department of Energy
DP	Dew Point
DPW	Directorate of Public Works
DX	Direct Expansion
ECB	Engineering and Construction Bulletin
EIFS	Exterior-insulated finish system
EPDM	Ethylene Propylene Diene M-class (rubber)
EPS	Expanded Polystyrene
ERDC	Engineer Research and Development Center
ERT	Earth Resistivity Tomography
ESTCP	Environmental Security Technology Certification Program
FGA	Fort Greely Alaska
FTR	Finned Tube Radiation
FWA	Fort Wainwright Alaska
GPR	Ground Penetrating Radar
HRV	Heat Recovery Ventilators
HUD	Housing and Urban Development
HVAC	Heating, Ventilating, and Air-Conditioning
IECC	International Energy Conservation Code
IMP	Insulated Metal Panel
IPC	International Plumbing Code

Abbreviation	Term
IR	Infrared
IRC	International Residential Code
IT	Information Technology
LCV	Low Calorific Value
LEED	Leadership in Energy and Environmental Design
LNG	Liquid Natural Gas
MILCON	Military Construction
MaxTTR	Maximum Time to Repair
NAVFAC	Naval Facilities Engineering Command
NEBS	Network Equipment-Building System
NERC	North American Electricity Reliability Council
NFS	Non-Frost Susceptible
NIPP	National Infrastructure and Protection Plan
NYSERDA	New York State Energy Research and Development Authority
O&M	Operations and Maintenance
ODB	Outside Dry Bulb Air Temperature
OSB	Oriented Strand Board
PPE	Personal Protective Equipment
QA	Quality Assurance
QC	Quality Control
RH	Relative Humidity
SHGC	Solar Heat Gain Coefficient
SRM	Sustainment, Restoration and Modernization
TDT	Thermal Decay Test
TPO	Thermoplastic Olefin
UFC	Unified Facilities Criteria
UL	Underwriters Laboratories
UPC	Uniform Plumbing Code
UPS	Uninterruptible Power Supply
USACE	U.S. Army Corps of Engineers
USCCSP	U.S. Climate Change Science Program
VLT	Visible Light Transmission
VTR	Vent Through Roof
WBGT	Wet Bulb Globe Temperature

Appendix A. Building Enclosure Testing on Alaska Military Base Projects

Airtightness testing of large buildings has been the subject of research since the early 1970s. Since then, whole-building airtightness testing has developed into a robust and vital building envelope commissioning industry. In 2009, the U.S. Army Corps of Engineers (USACE) implemented Engineering and Construction Bulletin (ECB) 2009-29 (HQUSACE 2009), which specified an airtightness requirement (maximum allowed air leakage) of below 0.25cfm/ft² @75Pa (4.5m³/h/m² @75Pa) for the six-sided building envelope surface area for all new construction and building enclosure renovation projects. The implementation of the building airtightness requirements over the past decade on U.S. Department of Defense (DoD) projects has dramatically improved awareness of the importance of air barriers systems. Each construction cycle since 2009 has achieved improvements in design and air barrier products, and installation practices contributed to a progressive learning curve. However, reviews of airtightness results and diagnostics of DoD projects in the Alaskan region over the past decade indicate that airtightness standards may need to be further increased.

This appendix, which presents results of airtightness testing performed by Emmett Leffel, Alaska Thermal Imaging LLC (Leffel 2021) at military installations in Alaska, identifies areas where air leakage pathways can be significantly reduced through better design and construction methods. Data drawn from test results include averages of new and renovation projects in Alaska, comparisons of 1950s and new construction, and comparisons of test results from large and small construction. These test results indicate the need for improved quality assurance during the design and contracting process and for increased airtightness requirements for commercial buildings in cold climates.

A.1 Introduction

Over the past 2 decades, the impact of building airtightness has been widely studied. Current literature (Anis 2001, Zhivov et al. 2014) confirms the impact that air leakage has on the overall building systems and emphasizes the importance of air barrier system performance. Recent studies of the thermal decay of buildings in an arctic climate identified building airtightness as a contributing factor to the resilience during thermal energy disruptions (Oberg et al. 2021).

The U.S. Army Corps of Engineers (USACE) implemented an airtightness requirement for all new construction and building enclosure renovation projects in 2009 (Engineering and Construction Bulletin [ECB] 2009-29) and in 2012 (ECB 2012-16) (HQUSACE 2009, 2012). The maximum air leakage allowed in both was 0.25cfm/ft² @75Pa (4.5m³/h.m²@75Pa) for the six-sided building envelope surface area. Over the past decade, the implementation of these airtightness requirements and testing has drastically improved design considerations, construction methods, and the general level of understanding of air barriers systems in DoD projects. Each construction cycle has since 2009 achieved improvements in design and air barrier products, and in installation practices resulting from a progressive learning curve.

The USACE air leakage testing protocol is a robust test parameter that broadens the allowable test conditions found in ASTM Standard E 779 (ASTM 2010). USACE requires testing in both directions, at higher induced pressures, and tighter increments of bias pressure readings. ECB 2009-29 (HQUSACE 2009, p. 23) includes a full list of deviations from the ASTM standards. These deviations, along with the standardization of the test procedure and building setup, allow testing with higher wind and temperature differentials while maintaining test result accuracies

and improving the repeatability of the test results under a wide range of conditions that suit building envelope testing in arctic regions.

Infrared diagnostic evaluations of the thermal building envelope and air leakage pathways under negative and positive building pressures are part of the USACE Air Leakage Testing requirements. ASTM C1060 (2015) and International Organization for Standardization (ISO) 6781 (1983) provide guidance on conducting qualitative thermal inspections of insulated building envelopes. With the building under neutral pressures, the thermal envelope is imaged under relatively stable conditions. Wind and stack effect must be taken into consideration and measured for reference purposes to isolate thermal anomalies from air leakage conditions. Following ASTM E1186 (2017), infrared (IR) images are taken from the low-pressure side of the building envelope with the building pressurized and depressurized. This combined IR inspection process from multiple standards accommodates imaging anomalies in the building envelope a minimum of three times under changing conditions. By inducing building pressures, a thermographer can effectively map air leakage pathways that can occur at different entry and exit points in the building envelope as well as air movement through an insulated assembly. The comparison of infrared images under changing pressures and conditions allows a trained thermographer to differentiate air leakage pathways from thermal anomalies. IR images taken following these guidelines allow air leakage pathways and thermal anomalies to be mapped in construction plan details, and where necessary, in elevation and plan views (see Figures A-2 through A-4).

The following sections of this appendix describe 31 building envelope results of tests performed in Alaska following the USACE *Air Leakage Testing Protocol for Building Envelopes* (USACE 2012). This review, categorization, and graphing of 10 years of test data, including comparisons of thermal performance of new buildings with airtightness of 0.25cfm/ft² at 75Pa and buildings at or below 0.15cfm/ft², reveals several important ways industry practices can be improved. Figure A-1 (Graph 1-3) shows airtightness testing results for buildings constructed before the implementation of USACE ECB 2009-29 (USACE 2009); the graph distinguishes between buildings that have been retrofitted (which are highlighted), and those left unimproved since their initial construction (some as early as 1949). The results and imaging included here may contribute to a new definition of what is considered sufficiently “airtight.”

A.2 Review of air barrier test results

From 2009 to 2019, Mr. Leffel has worked with general contractors, engineers, architects, and crews in the construction of 23 new buildings on Alaskan military bases, ranging from small to large building enclosures. All these newly constructed commercial buildings were air leakage tested and thermally imaged at or near completion of construction following the USACE *Air Leakage Test Protocol for Building Envelopes* (USACE 2012). With the exception of five projects, every project listed in Table A-1, met or surpassed USACE airtightness requirements on the first attempt. These results confirm the great success of USACE projects and are consistent with the much larger data sample reported in Zhivov et. al. (2014).

Figure A-1 (Graphs 1-1a and 1-2) shows the airtightness test results in cfm/ft² @75Pa of the new construction projects based on the year of construction. The overall average for all buildings tested by the author, of projects required to be 0.25cfm/ft² or less, is 0.158cfm/ft² @75Pa. Only two of the new buildings were CMU building types; 21 projects were primarily constructed with IMP wall systems. Table A-1 lists the roof and wall systems types for each building. Both CMU buildings tested below 0.1cfm/ft² @75Pa—some of the tightest construction types seen on Alaskan military projects. These two cases are reviewed in “The Tightest Air Barriers Examples”

(section A.6) in the discussion of things done right along with opportunities missed. IMP wall systems, while proven to be an excellent building envelope system when appropriately constructed, have given wide range of test results, from 0.07 to 0.35cfm/ft² @75Pa. The fact that four buildings achieved an airtightness less than 0.1cfm/ft² @75Pa (and nine buildings tested below 0.15cfm/ft² @75Pa) while others have difficulty reaching 0.25 cfm/ft² @75Pa reflects a complex problem that is heavily impacted by construction experience, attitudes, plan design, or constructability issues that can occur in commercial construction. In fact, the constructability of different air barrier materials can even be affected by such variables as weather and the time of year that construction takes place in an Arctic climate.

Table A-1. USACE airtightness testing at Alaskan military bases.

#	Building Type	Arch Plus CFM75/ft ²	Arch Only CFM75/ft ²	6-Sided Surface Area (ft ²)	Year of Construction	Date of Test Month-Yr.	Wall Type	Roof Type
1	FTW Barracks	0.328		34,442	1949	Oct-19	Concrete	PU
2	FTW Organization Storage HQ	0.242		66,012	1954	Oct-19	IMP/CMU	Concrete / EPDM (synthetic rubber)
3	FTG DPW Office/Shop	0.155		32,006	1955	Oct-19	Concrete	Concrete /EPDM
4	FTG Multi-Use	0.146		28,978	1955	Oct-19	CMU/ Framed	Concrete /EPDM I
5	FTW Tact. Vehicle Shop	0.2869		45,851	1988	Feb-12	2x Framed	Steel Pavers
6	FTW Plans Vault	0.095		8,489	1999	Oct-19	Stud Framed	VB/Attic
7	FTW Alert Holding Area	0.2128		220,692	2006	Nov-11	IMP/Steel Studs	Steel EPDM
8	FTW Pallet Proc. Facility	0.2267		151,490	2006	Oct-11	IMP	Steel EPDM
9	FTW Training Sup. Center	0.0716		63,895	2009	Sep-10	IMP	IMP
10	FTW MP Admin Facility	0.2171		6,541	2009	Jun-10	IMP	IMP
11	FTW (COF)	0.2046		34,189	2009	Apr-10	IMP	IMP
12	NOAA Sat. Op. Facility	0.1965		35,132	2009	Jun-10	VB-IMP	IMP
13	FTW Barracks	0.1985		132,460	2010	Dec-11	VB-IMP	Attic
14	FTW WIT SFAC	0.1356		18,484	2010	Sep-11	IMP	IMP
15	FTW WIT Barracks	0.102		51,152	2010	Sep-11	IMP	IMP
16	FTW WIT COH	0.189		22,180	2010	Sep-11	IMP	IMP
17	FTW Aircraft Parts Storage	0.119		51,840	2010	May-11	VB-EIFS	VB/Steel
18	FTR COF	0.1031		145,295	2011	Dec-12	IMP	IMP
19	FTW GSAB Hangar	0.226		132,435	2013	Aug-14	VB-IMP	VB/Steel
20	FTW COF		0.194	36,557	2014	May-16	VB-IMP	VB/Steel
21	FTW Duplex COF	0.164		64,000	2014	Sep-15	6" PU/ IMP	VB/IMP
22	EIE Bowling Center	0.082		40,448	2014	Aug-15	CMU	VB/Attic
23	FTW Battalion Head Quarters (B)	0.197		39,822	2015	Aug-16	VB-IMP	VB-Steel /EPDM
24	FTW Battalion Head Quarters (B)	0.208		39,822	2015	Oct-19	VB-IMP	VB-Steel /EPDM
25	FTW WS Hangar	0.145		147,492	2015	Sep-16	6" PU/ IMP	VB-Steel/EPDM
26	FTW Battalion Head Quarters (A)	0.196		39,021	2015	Mar-16	VB-IMP	VB-Steel /EPDM
27	EIE Training Facility	0.064	0.054	81,536	2017	Jul-18	CMU	VB/Steel

#	Building Type	Arch Plus CFM75/ft ²	Arch Only CFM75/ft ²	6-Sided Surface Area (ft ²)	Year of Construction	Date of Test Month-Yr.	Wall Type	Roof Type
28	CLR MCF	0.092	0.068	145,549	2018	Jun-19	IMP	VB/ EPDM
29	FTW UAS Hangar	0.253	0.244	58,116	2018	Jul-19	6" PU/ IMP	VB/Steel /EPDM
30	EIE FTD Facility	0.178	0.172	80,955	2018	Feb-19	VB/IMP	VB/Steel
31	EIE AGE Facility (0.4cfm75/ ft ² Target)		0.328	11,368	2018	Nov-19	IMP	VB/Steel
32	CLR ECF (0.4cfm75/ ft ² Target)	0.350	0.344	3422	2019	Mar-20	IMP	VB/EPDM

A.3 Averaged air barrier test results

Figure A-1 is a set of graphs of the air leakage test results for each subset group. Graph 1-1 shows test results for all cases listed in Table A-1. The area inside the red rectangle in Graph 1-1 is expanded in Graph 1-1a, which represents the airtightness results from 2009 to 2019 construction projects required to meet the 0.25cfm/ft² @75Pa or less. The average cfm/ft² @75Pa calculated for new construction test results is 0.158cfm/ft², as indicated with a red vertical line in Graph 1-1a. Projects that had an airtightness target of 0.4cfm/ft² @75Pa are outliers in this group and are not included in the average. Bldgs. 31 (2019) and 2 (1949) test results are comparable with ASHRAE’s and International Energy Conservation Code (IECC) commercial airtightness requirement and demonstrate how excessive air leakage can result in ice damming conditions in the immediate or mold conditions and degradation to the building envelope over time. Graph 1-2 charts building surface area against airtightness, further discussed in “Does Building Size Matter.” Graph 1-3 shows pre-2009 construction test results, for comparison. Note that buildings constructed before 2009 that had building envelope and ventilation upgrades completed fell within the standard deviation of 0.057 for new construction projects average airtightness. These results suggest that older existing DoD building infrastructure can be retrofitted to achieve the level of performance of new projects. The section “The Oldest vs. the Renovated” (section A.7) discusses pre-2009 ECB projects.

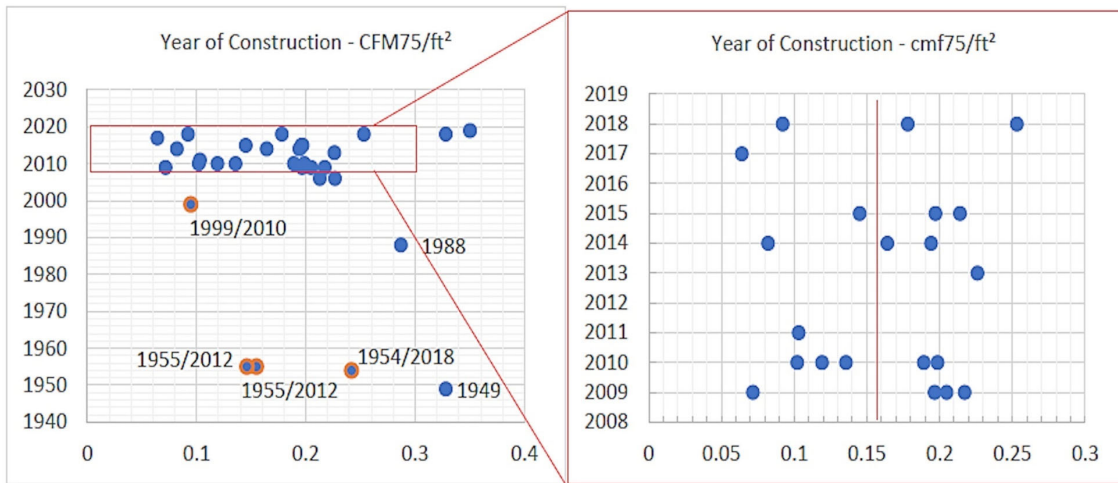

Graph 1-1. 1954–2019 Airtightness Results (cfm75/ ft²) (Year of Construction/ Retrofitted) Graph 1-1a. 2009–2019 Airtightness Results (cfm75/ ft²)

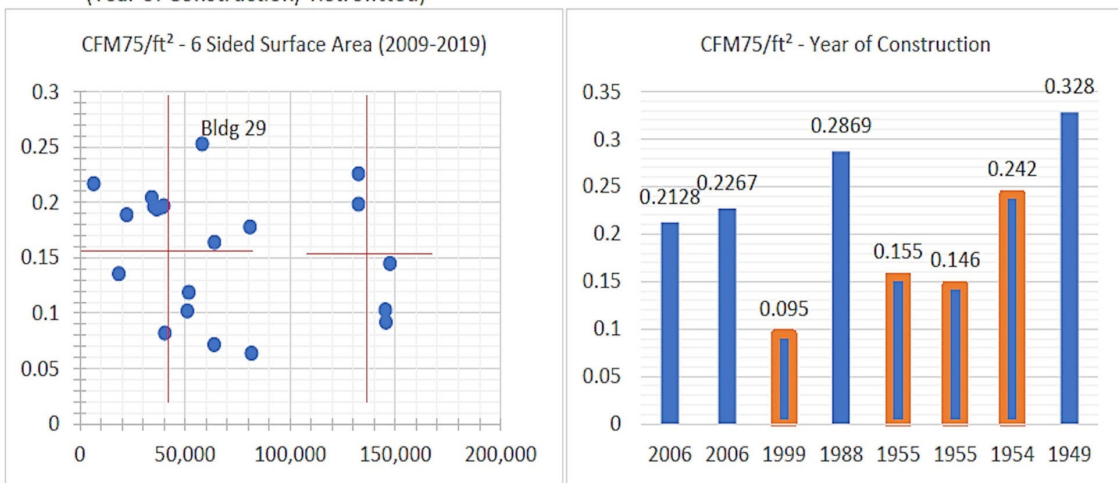

Graph 1-2. Leakage (cfm75/ft²) to Size, w/ Avg. Show Graph 1-3. 1949–2006 Airtightness Results (cfm75/ft²) (orange outline = Deep Energy Retrofit)

Figure A-1. Graphs 1-3 Air Leakage Test Results, 2009-2020.

A.4 Does building size matter?

The test results and surface areas for projects constructed from 2009 to 2019 charted in Graph 1-2, illustrate the leakage rates of large vs. small or medium-sized building envelopes. Building airtightness results for both large and medium-size projects averaged 0.153 and 0.160 cfm/ft² at 75Pa, respectively. Building size does not appear to significantly impact air barrier system performance. The vertical span of each group is spaced evenly with one outlier in the medium-sized group. (Bldg. 29 could be considered an outlier because of conditions explained below.) If Bldg. 29 is removed as an outlier, the average airtightness for medium and smaller envelope tests is lowered to 0.154cfm/ft² at 75Pa, almost the same as larger building envelopes. These results from tests in Alaska demonstrate that smaller buildings can be as airtight as larger buildings if they meet mandated airtightness requirements.

These results counter a long-held general assumption that smaller buildings typically have higher air leakage rates because of their higher window-to-wall ratios (Zhivov et al. 2014, p. 325). The general perception in the industry that the greater surface area of the larger

building permits a greater flexibility in designing for airtightness creates a self-fulfilling prophesy: if the airtightness requirement is set at 0.4cfm/ft² @75Pa, then the test results will rise to meet the relaxed requirement. Bldgs. 31 and 32 are clear examples of this phenomenon; their measured airtightness of 0.32 and 0.35 cfm/ft² @75Pa, respectively, are more consistent with 1950 construction standards.

A.5 Failures and lessons learned

Five buildings tested between 2014 and 2020 initially failed to meet the USACE airtightness requirement (Table A-2). A design change in construction types across all Alaskan military bases from IMP roof systems to a constructed steel roof deck system created opportunities for lessons learned in the design and construction phases. Of the buildings that initially failed to meet the USACE airtightness requirement of 0.25cfm/ft² @75Pa, three (Bldgs. 21, 24, and 26) failed due to a similar air leakage pathway identified at the roof-to-wall air barrier juncture. Thermography and smoke leakage testing were effectively used to identify areas of excessive air leakage pathways on each project. This air leakage pathway at the top flutes of the roof steel deck was identified as the primary air leakage pathway on each project. Once this air leakage pathway was sealed and largely corrected, as much as a 26% reduction in air leakage was achieved that allowed the buildings to comply with the USACE airtightness requirements and brought each project to completion. These case studies are discussed in detail below. Bldg. 29 was more complicated; its initial air barrier test failure of the Architectural Only Test of 0.276cfm/ft² @75Pa included other contributing factors. Although Bldg. 31 passed its building envelope test, it was somewhat of a unique outlier. These case studies illustrate how USACE Air Leakage Test Protocols could better impact building airtightness by examining how the protocols are used to test USACE projects. For example, Bldg. 32, one of the smallest projects, failed to meet the airtightness requirement of 0.4cfm/ft² @75Pa on an Air Force Base because of a design flaw. It was found that the air barrier design review and inspections that would have identified these flaws were not used on this small project.

Table A-2. Small, medium & large construction airtightness results (2009-2020).

Building No.	CFM/ft ² @75	6-Sided Surface Area (ft ²)	Year of Construction	Target CFM/ft ² @75	Failed Initial Test Results
<i>Small-Medium ABT Results</i>					
27	0.064	81,536	2017	0.25	
30	0.178	80,955	2018	0.25	
21	0.164	64,000	2014	0.25	
9	0.0716	63,895	2009	0.25	
29	0.253	58,116	2018	0.25	0.276
17	0.119	51,840	2010	0.25	
15	0.102	51,152	2010	0.25	
22	0.082	40,448	2014	0.25	
24	0.197	39,822	2015	0.25	0.269
26	0.196	39,021	2015	0.2	0.214
20	0.194	36,557	2014	0.2	0.250
12	0.1965	35,132	2009	0.25	
11	0.2046	34,189	2009	0.25	
16	0.189	22,180	2010	0.25	
14	0.1356	18,484	2010	0.25	
10	0.2171	6,541	2009	0.25	
Averages	0.160	45,242	2009-2018		

Building No.	CFM/ft ² @75	6-Sided Surface Area (ft ²)	Year of Construction	Target CFM/ft ² @75	Failed Initial Test Results
Standard Deviation	0.057	21,092			
31 (outlier)	0.328	11,368	2018	0.4	
32 (outlier)	0.350	3422	2020	0.4	0.434
Large Envelope ABT Results					
25	0.145	147,492	2015		
28	0.092	145,549	2018		
18	0.1031	145,295	2011		
13	0.1985	132,460	2010		
19	0.226	132,435	2013		
Average	0.153	140,646	2010-2015		
Standard Deviations	0.058	6,737			
Pre-ECB-2009 Construction				Year Remodeled	
7	0.2128	220,692	2006		
8	0.2267	151,490	2006		
6	0.095	8,489	1999	2010	
5	0.2869	45,851	1988		
3	0.155	32,006	1955	2012	
4	0.146	28,978	1955	2012	
2	0.242	66,012	1954	2018	
1	0.328	34,442	1949		
Average	0.21155	73,495	1949-2006		
Standard Deviations	0.0769	73,702			

Bldg. 26 did not initially meet the USACE airtightness requirement. Thermal imaging completed before building envelope testing (BET) revealed significant air leakage at the rake walls (see the IR images in Figure A-2). The retrofit developed in the field at the time was simple: plug the holes. The primary contributing air leakage pathway was identified and sealed at the top flutes of the steel roof pan decking by drilling ¼-in. holes in the flutes and inject high expansion can foam at each pan decking trough. This retrofit was effective and allowed the project to complete on time. Bldgs. 24 and 26 are similarly designed and built by two different general contractors at about the same time. Surface area calculations were slightly different, but the air leakage pathways were almost exactly the same. After air-sealing improvements were made to both Bldgs. 24 and 26, final air leakage was measured at 0.196 and 0.197cfm/ft² @75Pa, respectively.

The post-construction air-sealing method of injecting can foam into the top flutes of the steel roof decking should only be used in retrofit applications. See Figures A-3 and A-4 for details. In more recent projects, this retrofit has been used on similar roofs by filling flutes during the construction of the roof, thus creating a cold joint between foam and dens decking. These methods were used in Bldg. 31 with vastly different results, discussed in detail below. Recent design reviews on 2020 projects included recommendations for filling the troughs with foam at the rake walls during the construction of the roof, where troughs are perpendicular to the wall line, and setting the DensDeck in a bed of caulking at all exterior wall lines to further minimize air leakage above the roof decking at the roof-to-wall juncture.

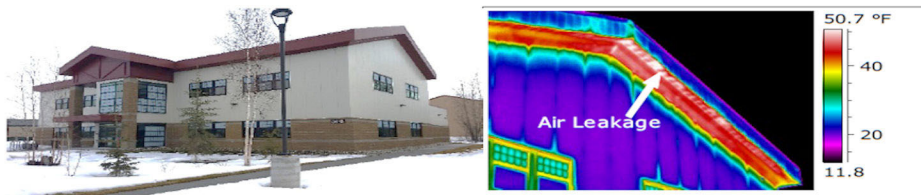

Image 2-1. Bldg. 24,26 Typ. Construction

Image 2-2. Bldg. 26 IR Roof/Wall Joint @+25Pa

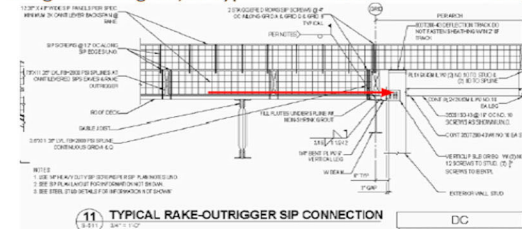

Image 2-3. Building 21,24,26 Rake Wall Plan Detail

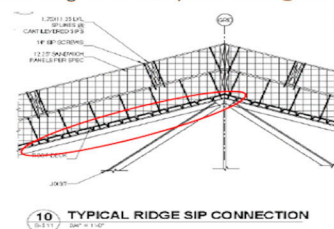

Image 2-4. Building 21,24,26 Roof Profile

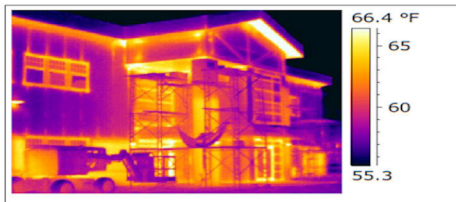

Image 2-5 Bldg. 24 IR Roof/Wall Joint @+25Pa

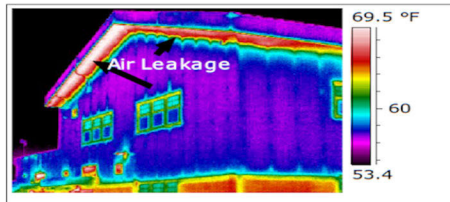

Image 2-6 Bldg. 24 IR Roof/Wall Joint @+25Pa

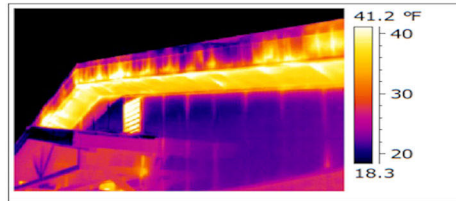

Image 2-7 Bldg. 21 IR Roof/Wall @+25Pa

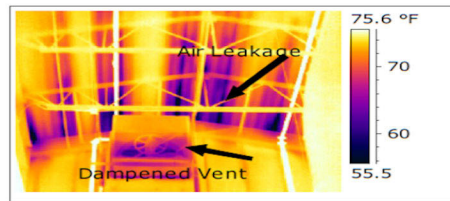

Image 2-8 Bldg. 21 IR Roof/Wall @-25Pa

Figure A-2. Failures and lessons learned; Bldgs. 21, 24, and 26, IR and plan details.

Bldg. 29 is constructed with an IMP wall system and 6 in. of polyurethane @ the interior. The steel roof is constructed with a vapor barrier on the warm side of the insulation. The hangar section was excluded from the air barrier test requirements (Figure A-3-1). This project failed its initial air leakage testing with an area separation wall included as part of the six-sided building envelope. Significant air leakage pathways were located at the area separation wall between the hangar and office area, which was mapped independently of other walls sections using fog. Air leakage also existed at the parapet and rake walls due to an unsealed gap in the air barrier at the top of wall juncture. These air leakage pathways are outlined in plan and elevation view drawings in Figures A-2 and A-3. Sealing the area separation wall was completed quickly and cost-effectively, allowing the building to pass the test requirement and construction to finish. The final Architectural Only air leakage test results were 0.244cfm/ft² @75Pa. Because the test zone also included the area separation wall but not the whole-building envelope, more costly and invasive air-sealing retrofits at the exterior building envelope did not need to be prioritized to pass the USACE air leakage test requirement. For these reasons, including an area separation wall as part of the six-sided building envelope may not be an effective method in verifying an airtight separation wall or the building envelope enclosure tightness. The air leakage of either wall type impacts the building differently; because of this, area separation walls should be tested differently and even at different airtightness requirements. Fog leakage testing and guarded tests could be used in demonstrating and calculating cfm/ft² of an Underwriters Laboratories (UL) listed area separation wall. Testing these walls independently of the exterior building envelope may help to improve knowledge of UL listed walls in the construction

industry, specifically of how area separation walls leak air and how they could be better built to achieve air sealing between different building zones. Bldg. 25 is a single zone warm storage hangar similar in design to Bldg. 29. Bldg. 25 passed the airtightness requirements at 0.145cfm/ft² @75Pa. Including a hangar or maintenance inspection bay in the whole-building air barrier tests in Alaska, where these zone types are typically entirely inside the air and thermal barrier boundaries, is practical.

Air Barrier Testing Zone

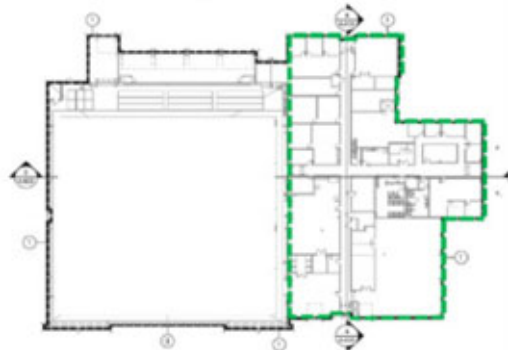

Image 3-1. Building 29 Air Barrier Test Zone

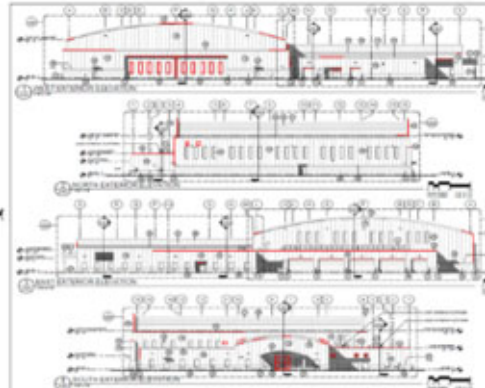

Image 3-2. Building 29 Air Leakage Pathways

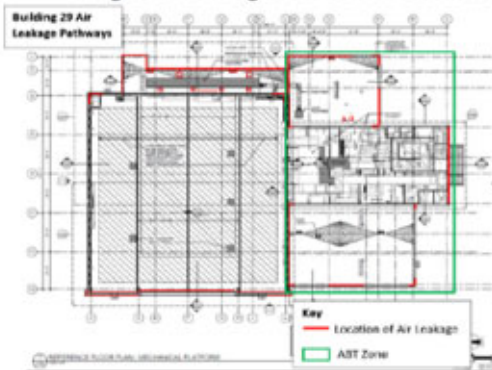

Image 3-3. Building 29 Air Leakage Pathways



Image 3-4. Building 29

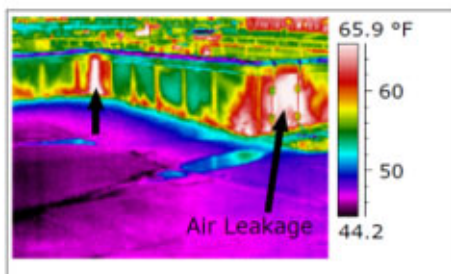

Image 3-5 Building 29 Parapel Corners @+25Pa

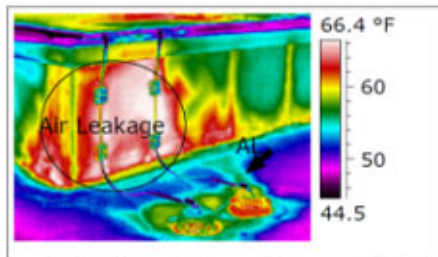

Image 3-6 Building 29 Parapel Corner @+25Pa

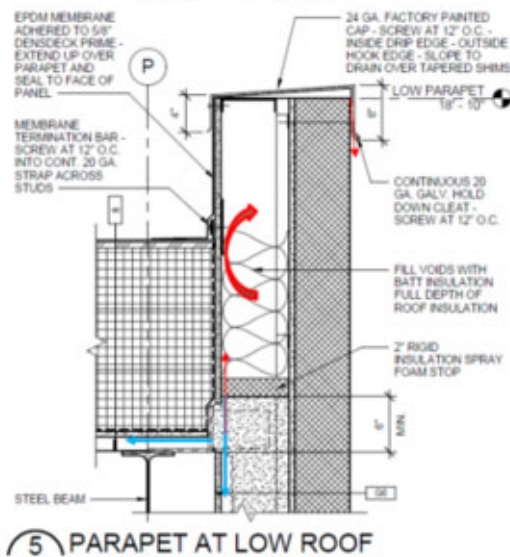

Image 3-7 Building 29 Parapel Detail (Mapped Air Leakage)

Figure A-3. Failures and lessons learned; Bldg. 29, IR and plan details.

Bldg. 31 passed the Air Force airtightness requirements of 0.4cfm/ft @75Pa, at 0.328cfm/ft². Extensive air leakage building-wide at critical air barrier joints was found with subsequent ice damming conditions occurring in the first year at the northwest building corner, which created a severe slip, trip, and fall potential. (See the IR image in Figure A-4-1 where air leakage from the mechanical room is filling the rake wall soffit and adjacent eave soffit with warm air.) A design detail that demonstrates an effective and constructible plan that transitions the roof air/vapor barrier down through the roof steel decking flutes and ties appropriately into the wall air barrier at all eave and rake walls must be developed. Additionally, improvements are needed in quality control of the roof air barrier. All portions of the air barrier, including the roof air barrier should be verified at the time of installation by someone with knowledge of the installation of air barriers. The heated and conditioned maintenance inspection and garage bays were not included in the air barrier test zone under the Unified Facilities Criteria (UFC) 3-101-01 exceptions for air barrier testing (USACE et al. 2019, p. 3-6.3). Bldg. 31 had air leakage pathways consistently at rake walls, parapet walls, and horizontal IMP joints for long sections at critical air barrier joints. During building envelope air leakage testing and diagnostics, changes in indoor temperatures and relative humidity were noticeable in zones having significant air leakage. These conditions and airtightness requirements reflect the potential in ASHRAE and IECC minimum code construction and highlight future opportunities in deep energy retrofits for existing and new construction.

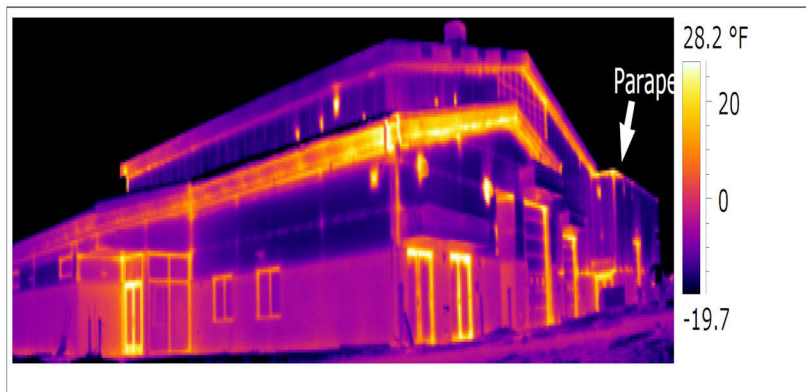

Image 4-1 Building 31 (0.328cfm/ft² @75Pa) Northwest Building Corner @+25Pa

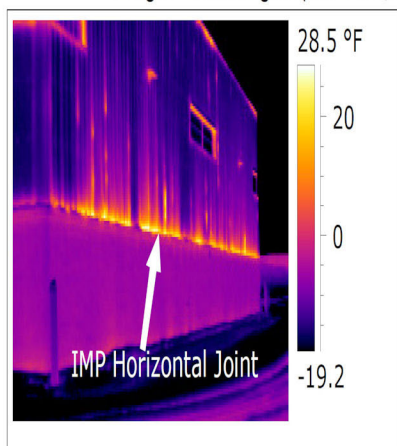

Image 4-2 Bldg. 31 IMP Horizontal Wall Joint @+25Pa

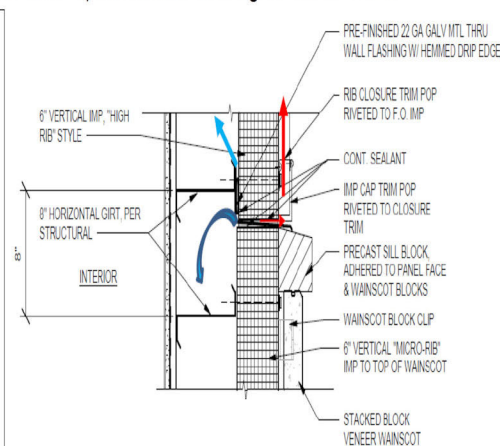

Image 4-3 Bldg. 31 IMP Horizontal Wall Joint Detail

Figure A-4. Minimum code construction, Bldg. 31 (0.4cfm/ft² @75Pa requirement).

A.6 The tightest air barrier examples

Bldg. 27, which was constructed in 2017, tested at 0.054cfm/ft² @75Pa. The thermal envelope is a CMU wall system with Rockwool at the interior side of the CMU and a self-adhered air barrier at the warm side of the wall system. A vapor barrier is located at the steel roof pan decking. An air barrier design review, air barrier mockup, and air barrier inspections were completed during the air barrier installation. Note that the steel roof deck and vapor barrier roof assembly of Bldg. 27 are the same as that of Bldgs. 21, 24, and 26, but Bldg. 27 did not have the same failed air barrier joint condition at the rake walls. The gap in the air/vapor barrier at the top flutes of the steel deck was sealed by injecting foam at the rake wall assemblies in a retrofit application while the exterior soffits were open. The IR images in Figure A-5 show the impact and overall airtightness performance of this building. Minimal amounts of air leakage were found. This project included an air barrier design review, inspections, and a mockup of the air barrier that included HVAC fenestrations, a building corner, and the roof-to-wall juncture.



Image 5-1. Bldg. 27 CMU Wall & Metal Roof

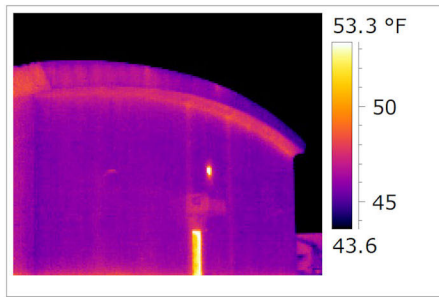

Image 5-2. Bldg. 27 CMU Rake Wall @+25Pa

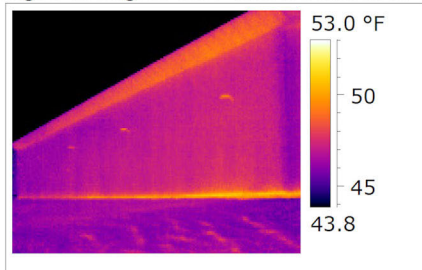

Image 5-3. Bldg. 27 Eave & CMU wall @+25Pa

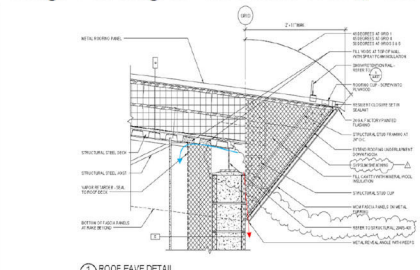

Image 5-4. Bldg. 27 Plan Detail of the Eave

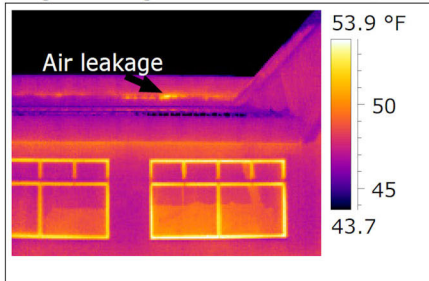

Image 5-5. Bldg. 27 Upper Roof Eave @+25Pa

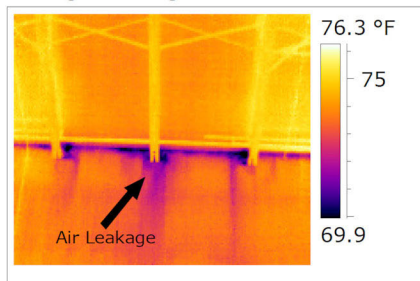

Image 5-6. Bldg. 27 Upper Roof Eave @-25Pa

Figure A-5. The tightest building examples; Bldg. 27, IR and plan details.

Bldg. 10, which was constructed in 2009, had an airtightness of 0.0716 cfm/ft² @75Pa. The thermal envelope is constructed entirely of IMP wall and roof systems; it was the tightest of IMP projects. Contractor crews were diligent and methodic at air sealing at the roof-to-wall joints, IMP joints, and building corners. Air leakage was found primarily at the base of the IMP wall-to-slab edge, at the translucent panels, and at exterior doors. Very little air leakage was located at the roof-to-wall joints, building corners, or roof sections. The IR images in Figure A-6 show areas that could easily have been improved during construction.



Image 6-1. Building 10 IMP Wall and Roof



Image 6-2. Building 10 Panoramic IR Image @+25pa

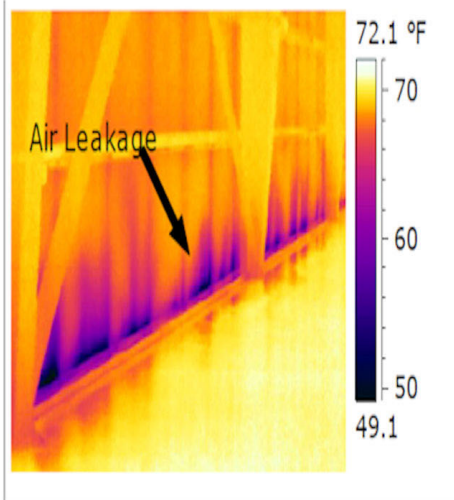

Image 6-3. Building 10 Air Leakage Pathways @-25Pa

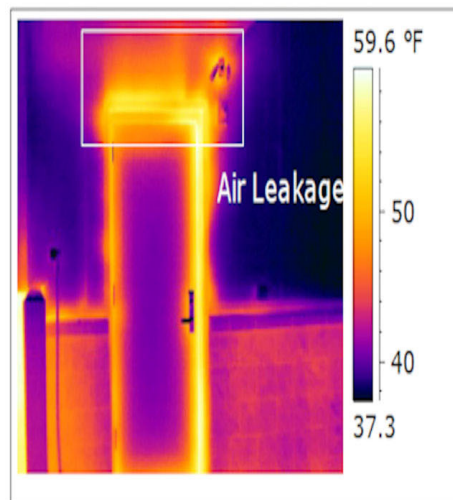

Image 6-4. Building 10 Plan Detail of the Eave @+25pa

Figure A-6. The tightest building examples; Bldg. 10 digital and IR imagery.

Bldg. 23 air leakage tested at 0.082cfm/ft² @75Pa. The CMU wall system had very few windows and doors because of its use as a bowling center. This project also has an attic space with metal trusses. Air barrier design review and air barrier inspections played an important role in identifying a gap at the CMU wall-to-ceiling joint and an interior wall partition top plate. Air barrier inspections identified air leakage pathways around HVAC low-leakage dampers and other air leakage pathways during construction as well. These types of quality controls have had a positive impact on projects where air barrier performance is tested. While this project far surpassed the airtightness requirement, opportunities still existed for air sealing and thermal barrier improvements. Figure A-7 shows examples of remaining air leakage and overall thermal signatures of the CMU wall system.



Image 7-1. Building 23 CMU Wall & Attic Ceiling

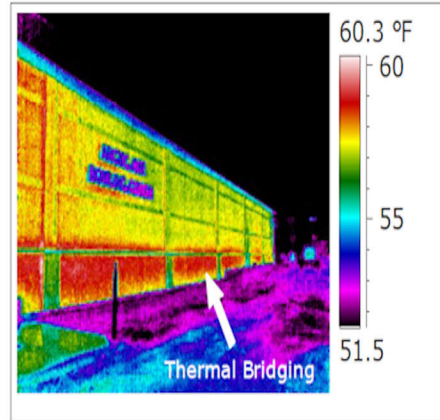

Image 7-2. Building 23 @+25Pa

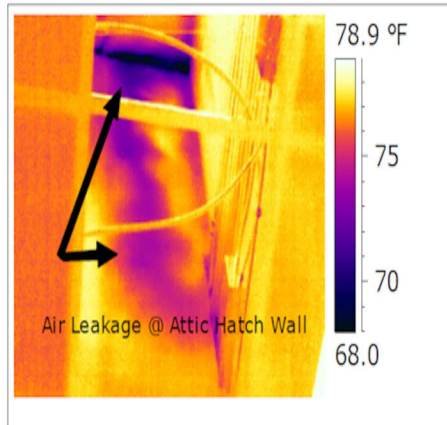

Image 7-3. Building 23 Attic Hatch Wall @-25Pa

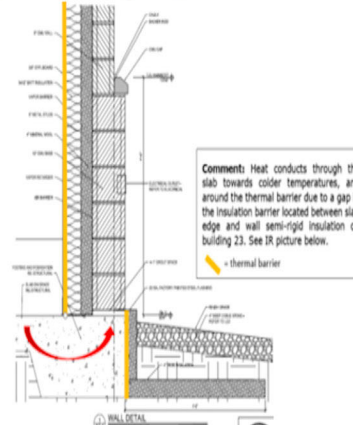

Image 7-4. Building 23 Slab Edge Plans Detail

Figure A-7. The tightest building examples; Bldg. 23 IR and plan details.

A.7 The oldest vs. the renovated

Eight of the buildings tested were constructed before implementation of the 2009 ECB airtightness requirements. Four of the eight buildings were extensively remodeled. Bldg. 2, which was constructed in 1949, is the oldest building of the group and has had no building envelope upgrades. Of these eight buildings, the 1949 construction located at Fort Wainwright has the highest air leakage, as might be expected due to its age and condition. Bldgs. 4 and 5 located in Fort Greely have similar life spans as Bldg. 2 but have less than half of the total air leakage because of their extensive building envelope and HVAC upgrades. Bldgs. 4 and 5 both are in the lower range of airtightness in this group at around 0.15cfm/ft² @75Pa. Bldg. 3 in Fort Wainwright has had several envelope upgrades, including IMP wall upgrades to the exterior of the original CMU walls and HVAC upgrades with low-leakage dampers; however, it remains the third leakiest building envelope in this group. Buildings that have been renovated along with the two largest buildings constructed before 2006 all meet current USACE airtightness requirements. See Table A-1 in Appendix A for wall and ceiling construction types.

Bldg. 2, had an air leakage result of 0.328cfm/ft² @75Pa. The building has single-pane, double hung aluminum windows that have significant air leakage. The roof is steel with polyurethane and fire coating, but even this had air leakage at pinholes, expansion joints, and CMU fire break walls in the hot attic. This barracks building, which now sits vacant after 70 years of service, needs either renovations or demolition. Air leakage was found at the roof-to-CMU rake walls,

structural beams, roof eaves-to-wall joints, roof peaks, windows, doors, and HVAC terminations inside cupolas. Moisture signs are typical in this building wherever air leakage is found due to the extreme climate zone, the building's age, and its high occupancy. Mold conditions were evident at locations such as expansion joints where significant air leakage pathways were found, and continuous wetting occurred for up to 9 months out of a year from condensation.



Image 8-1. Building 2 Concrete Wall/Steel Roof

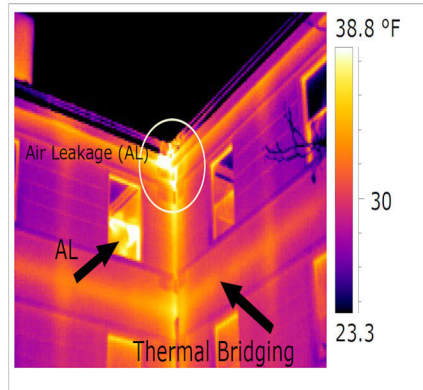

Image 8-2. Building 2 Roof to Wall Joint IR @+25Pa.

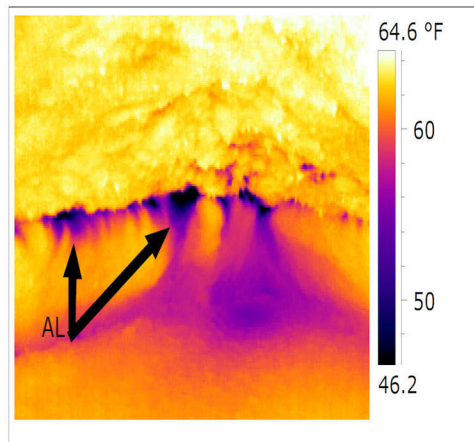

Image 8-3. Building 2 Air Leakage Pathways



Image 8-4. Building 2 Roof to Wall Joint Dig.

Figure A-8. Bldg. 2. Air Leakage at 0.328cfm/ft² @75Pa showing several air leakage pathways.

Bldg. 3, which was constructed in 1954 of CMU, is used as a storage/ maintenance facility. The building envelope and HVAC ventilation systems were upgraded in 2018 with an IMP wall at the exterior side of the CMU wall, new HVAC equipment, and dampers, overhead doors, and windows. The building envelope meets current USACE airtightness standards at 0.242cfm/ft² @75Pa. However, when the building is pressurized, thermal imaging shows a much different thermal signature than might have been expected from a “tight” envelope. Air leakage pathways were primarily found at the wall-to-roof joints, IMP joints, and all fenestrations. No visible signs of moisture at the building envelope were found during the IR inspection. This building is slightly pressurized during normal building pressures with the HVAC equipment in operation. Because of this, the building's age, and possibly because of the significant air leakage pathway at the roof-to-wall joint, a slight mildew smell could be detected at electrical outlets boxes and inside the insulated wall cavity. Thermal imaging, airtightness testing, and air barrier inspections can identify these concerns in the design and construction phases. Air leakage signatures were consistent building-wide at critical air barrier joints such as the parapet wall system, roofing, and IMPs.

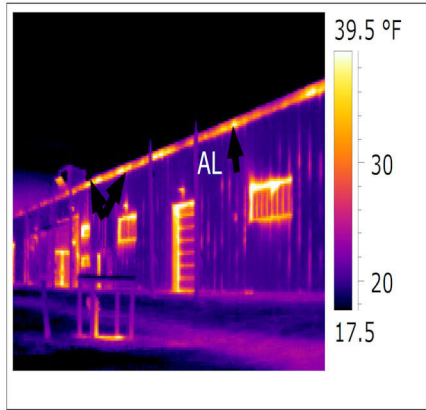

Image 9-1. Building 3 Air Leakage Pathways @+25Pa



Image 9-2. Building 3 Storage Facility and Shop

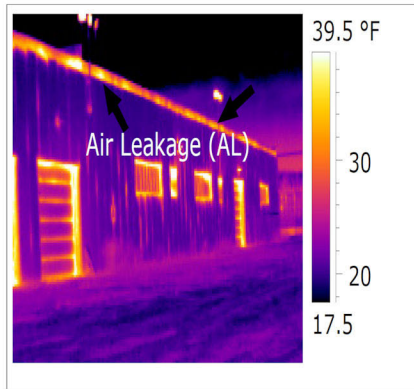

Image 9-3. Building 3 Air Leakage Pathways @+25Pa

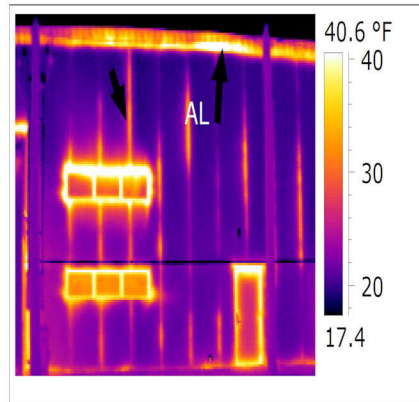

Image 9-4. Building 3 Air Leakage Pathways @+25Pa

Figure A-9. Bldg. 3, (0.242cfm/ft² @75Pa) showing common air leakage pathways of IMP.

Bldgs. 4 and 5 were both constructed in 1955 and remodeled around 2012 with an EIFS wall retrofit, some windows, and limited HVAC upgrades. The air leakage tests for Bldgs. 4 and 5 were 0.155cfm/ft² @75Pa and 0.146cfm/ft² @75Pa, respectively. Air leakage was primarily found at the original HVAC louvered vents, windows, and doors that had not been upgraded. The thermal envelope upgraded walls performed exceptionally well with regards to thermal and air barrier performance when imaged (see Figure A-10-1 through A-10-5). The air leakage pathways were minor in comparison to projects having 0.25cfm/ft². The EIFS retrofit, along with HVAC upgrades, were successful, and air leakage pathways identified during diagnostics demonstrated that these buildings could have easily achieved even tighter construction.

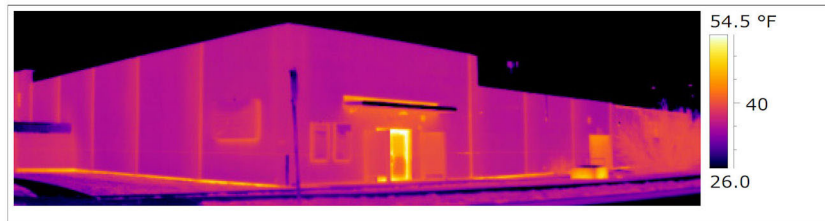

Image 10-1. Building 5 Panoramic of EIFS Wall in the Iron Pallet @ +25 Pascals



Image 10-2. Building 4 Shop Photo

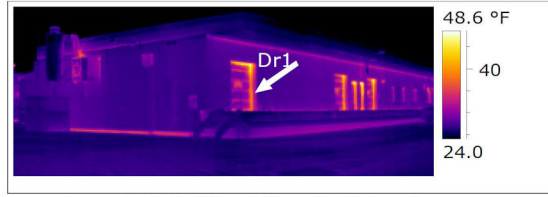

Image 10-3. Building 4 Shop @+25 Pascals

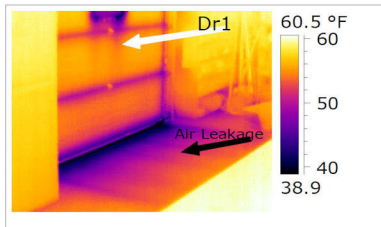

Image 10-4. Building 4 Overhead Door @-25Pa

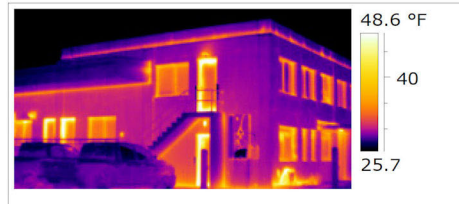

Image 10-5. Building 4 Fenestration & EIFs @+25 Pascals

Figure A-10. Bldgs. 4 and 5, thermal signatures of EIFS wall @air leakage pathways.

A.8 Architectural Only or Architectural Plus HVAC testing

Five buildings were tested following both building test set up protocols, the Architectural Only (Arch Only) and the Architectural Plus HVAC (Arch Plus) as originally defined in the USACE Air Leakage Test Protocol (USACE 2012). Section 4.8.2: Preparation of the building, options a (Arch Only) and b (Arch Plus) requirements, “masking or unmasking” of “intentional” holes outlines these parameters. Figure A-11 shows a graph of the test results for Arch Only and Arch Plus. They are a small sample set, but consistently the Arch Only test, which requires masking exterior HVAC louvers, has a lower cfm/ft^2 , as expected. Where both tests have been required, the Arch Only test goal was set at $0.25\text{cfm}/\text{ft}^2$ @75Pa and the Arch Plus test was typically set at $0.3\text{cfm}/\text{ft}^2$ @75Pa. Before this change, the projects were typically tested with dampers closed and unmasked at the test goal of $0.25\text{cfm}/\text{ft}^2$, resulting in a potential 20% drop in the airtightness requirement for the Arch Only testing.

For buildings that have completed both the Arch Only and Arch Plus tests, the percentage differences between the two-test setup “Masked or Unmasked” vary significantly from 1.7% to 26% (Table A-1 Bldg. 27-30, 32). These test results are easily affected by uncontrollable scenarios making them less repeatable. For example, several conditions that can influence the Arch Only tests negatively are:

1. The difficulty and repeatability issues in applying tape or self-adhesive grille wrap in cold or wet climates. For example, see Figure A-11-2 and A-11-3.
2. Tape or self-adhesive grille wrap sealed to the exterior wall assembly instead of properly sealing just the intentional openings at the air barrier boundary. For example, see Figures A-11-4 and A-11-5. Figures A-11-6 and A-11-7 demonstrate the potential air leakage at louvered HVAC vents.
3. Variations in the test results between projects due to differences in HVAC systems design, size, and potential impact to building setup from one building to the next.

Due to this sample set size, the results should not be used to draw any conclusions. However, these issues may outline where USACE testing schemes and protocol variations could impact airtightness results negatively. Based on a literal interpretation of Section 3-6, “Air Barrier Requirements,” in UFC 3-101-01, *Architecture* (NAVFAC 2019), the air barrier system must be a continuous plane. The routinely masked low-leakage dampers are intended to be part of the air barrier system, not an intentional opening. Low-leakage dampers are much like an operable window; they are part of the architectural boundary and air barrier system. From the authors’ perspective, the only benefit from masking and unmasking low-leakage dampers for USACE airtightness testing is to highlight the air leakage pathway around dampers that were not installed using airtight methods, or dampers that have not been properly commissioned. According to UFC-3-101-01, Section 3-6, the air barrier must properly transition through all fenestration types to be effective. Eliminating the redundancy in testing, especially in cold climates where no intentional openings typically occur, offers the greatest cost savings potential for testing and an incentive for tighter construction at low-leakage dampers; one of the last low hanging fruits in airtightness.

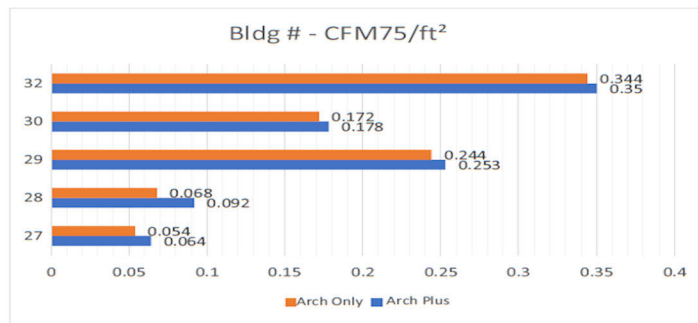

Figure 11-1 Graph Architectural Only Vs. Architectural Plus HVAC Test (CFM75/ ft²)



Image 11-2 EIFS Hood Termination Sealed (Winter)



Image 11-3 EIFS Louver Wall Termination Sealed (Winter)



Image 11-4 IMP Louver Termination Sealed



Image 11-5 CMU Louver Wall Termination Sealed

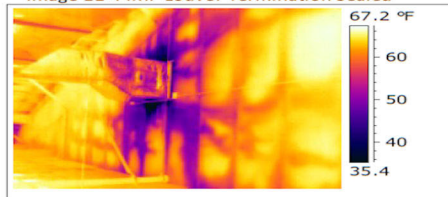

Image 11-6 Bldg. 19. Louver Termination @-25Pa

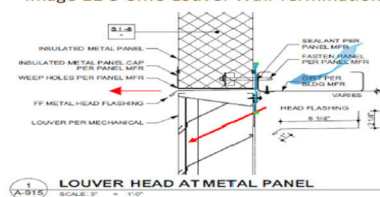

Image 11-7 Louver Wall Termination Detail

Figure A-11. Architectural Only vs. Architectural Plus HVAC Test and Examples.

A.9 Conclusion

A review of the past 10 years of air leakage test results at military installations in Alaska has revealed several key points and issues. When outliers were excluded, DoD Buildings constructed in Alaska achieved an average airtightness of 0.158cfm/ft² @75Pa, which is substantially tighter

than current USACE requirement of 0.25cfm/ft² @75Pa but is consistent with 2014 research (Zhivov et al. 2014, p. 322) based on a much larger sample set. A comparison of Bldg. 5 at 0.155cfm/ft² and Bldg. 3 at 0.242cfm/ft² @75Pa showed significant differences both in measured air leakage rates and in IR images. These thermal signature differences in air barrier performance occurred with new construction projects as well, e.g., Bldg. 10 at 0.0716cfm/ft² in comparison to Bldg. 29 at 0.253cfm/ft².

The extent of the air leakage and location at critical air leakage pathways typically seen in buildings at 0.25cfm/ft² or higher comprise the defining difference between airtight buildings with leakage rates less than 0.15cfm/ft² @75Pa. and those with much greater leakage such as Bldg. 31, with 0.32 cfm/ft² @75Pa, where prominent air leakage pathways occurred at parapet walls and rake walls for long sections. Note that Bldg. 31, which was constructed in 2019 to Air Force airtightness requirements of 0.4cfm/ft² @75Pa, is consistent with ASHRAE and IECC optional airtightness requirements.

More recently constructed projects that have higher air leakage test results have become a trend. Experienced general contractors and project teams that have completed several projects are well aware of the amount of time and effort needed to pass the USACE airtightness requirement. The differences in recently constructed projects that have resulted in airtightness between 0.25cfm/ft² and 0.15cfm/ft² coupled with the progressive learning curve required to build airtight buildings, raises concerns that a competitive construction industry may be more likely to produce buildings closer to 0.25cfm/ft² and 0.4cfm/ft² than at 0.1cfm/ft² @75Pa if requirements or incentives for tighter construction do not progress as well. Tighter construction requirements may be warranted to reverse this trend, and to stem the resulting potential for ice damming conditions and long-term degradation to the building envelope resulting from air leakage.

A review of the USACE testing protocol through revisions or updates could also have benefits. Projects before 2016 were tested and required to be tighter than 0.25cfm/ft² @75Pa with airtight HVAC dampers mechanically closed typically. Incorporating the Architectural Only (masked) and the Architectural Plus HVAC (unmasked) tests has effectively lowered the bar by as much as 20%, with the Architectural Plus HVAC testing typically increased to 0.3cfm/ft² @75Pa. Additionally, air barrier zone testing and the exclusion of hangars and maintenance bays per UFC guidelines may have drawbacks, as exemplified by the performance of Bldg. 29, especially when considering that these excluded zones are typically conditioned in Alaska's Climate Zone 8. Area separation wall assemblies between zones are critical wall assemblies that deserve attention because they differ in construction and airtightness requirements. While area separation walls are UL listed, they have not been tested for airtightness. In fact, air leakage diagnostic and testing protocols that isolate area separation wall assemblies have not been developed yet. However guarded tests and the use of fog could be simple and effective testing options. These areas offer the greatest opportunities for improvement in future revisions and updates to the USACE testing protocol.

One of the more interesting finds in the testing results was the similarity in average airtightness between medium-sized and large building envelopes, at around 0.15cfm/ft² @75Pa, when outliers were eliminated from the group. This striking similarity in the airtightness performance of large and small building envelopes counters industry perceptions that small building envelopes are inherently less airtight and suggests rather that airtightness testing requirements themselves may have had a primary impact on the airtightness of small and medium buildings. While many other factors may also come to bear, including the contractor experience level and

their understanding of the impact of building envelope size on air barrier testing, these fresh findings certainly require further testing.

Based on our findings the following recommendations are made:

1. Requirements to building airtightness in cold and arctic climates can be tightened to 0.15cfm/ft² @75Pa without significant increase in the construction costs. In most cases this will not change the currently used air barrier technologies or construction methods but may require improved Quality Assurance (QA) and Quality Control (QC) during construction.
2. The labor, time and the cost required for air barrier testing in cold and arctic climates can be significantly reduced by eliminating the redundancy in testing and not masking where HVAC low-leakage dampers are used, and no other intentional openings exist.
3. Include hangar and maintenance bays in testing requirements in arctic climates and incorporate zone separation wall testing and diagnostics where practical to improve the resilience and long-term durability of USACE projects.

Appendix B. Thermal Energy System Resilience: Thermal Decay Test (TDT) in Cold/Arctic Climates

B.1 Objectives and scope

Thermal energy systems resilience is especially important in extreme climates such as arctic or tropical environments. While metrics and requirements for availability, reliability, and quality of power systems have been established (DoD 2020), similar metrics and requirements for thermal energy systems are not well understood. In one of the first attempts to address this deficiency, a study was conducted to better determine the level of reliability required for energy supply systems that will be able to support environmental conditions required for the facility's mission, comfort of people, and sustainment of a building in arctic environments under predominant threat scenarios.

The objectives of the studies described in this appendix were to obtain real life information on the indoor air temperature decay in buildings when they experience a problem with heat supply and evaluate how much time is available to fix the problem before the indoor air temperature reaches habitability or sustainability thresholds (Zhivov et al. 2021a); to identify areas in the building that are the most vulnerable to disruption of heat; and to provide the information to calibrate models that can be used to predict temperature decay in different archetypes of mission critical facilities (building mass, insulation characteristics) and air leakage rate. Tests were conducted in five buildings located at Fort Wainwright (FWA) and Fort Greely (FGA) in January 2020 with the outdoor air temperature ranging between -20 °F and -40 °F (-29 °C and -40 °C). As was discussed in the previous section of the appendix, building airtightness is a significant factor affecting loss of heat by the building. To obtain this information for selected five buildings, blower door tests were conducted in July 2020. Before these tests, the team collected the data available from drawings, specifications, retrofits, and building walk-through.

Information provided in this appendix is based on research performed under the International Energy Agency's Energy in Buildings and Communities Program Annex 73 "Towards Net Zero Resilient Public Communities," the DoD Environmental Security Technology Certification Program project EW18-D1-5281, "Technologies Integration to Achieve Resilient, Low-Energy Military Installations," the Office of the Deputy Assistant Secretary of the Army project "Thermal Energy Systems Resiliency for Army Installations located in cold climates," and the U.S. Army Program 633734T1500, Military Engineering Technology Demonstration project.

B.2 Methodology

To establish guidelines for maximum time to repair thermal systems before habitability or sustainability thresholds are reached, it is important to understand the external factors that contribute to a building's thermal decay, to what extent these factors play a role, and the distribution of indoor air temperature throughout the building during a thermal energy disruption. To better understand these factors, a novel TDT was developed to simulate a thermal energy disruption to a military installation. This test involved instrumenting the building with temperature sensors, removing the heat sources to the building, and recording air and surface temperatures in different areas of the building over an extended period of time. To establish some level of consistency and to streamline the process, a test protocol was established for this test. Data collected in this test were used in conjunction with building models to predict maximum time to repair across different building types.

Indoor temperatures were recorded using surface and ambient temperature sensors. These sensors were placed in key locations throughout the buildings. These locations were chosen to capture baseline data in critical areas (mechanical rooms, exposed waterlines, etc.) and in areas susceptible to the effects of wind. Additionally, sensors were placed near exterior doorways to better establish the effects of researchers opening doors while monitoring the buildings. For the surface temperatures, UX120-006M HOBO dataloggers with four TMC20-HG temperature probes (Accuracy: ± 0.27 °F [± 0.15 °C]) were used. These sensors were placed in corners of the buildings to analyze temperature differences in windows, walls, ceilings, and floors. The surface temperature on internal and external walls were measured and analyzed with special attention paid to the difference between internal versus external walls, wall orientation, and walls below versus above grade. For the interior ambient temperatures, UX100-003 HOBO dataloggers (Accuracy – Temp: ± 0.38 °F (± 0.21 °C); RH: $\pm 2.5\%$) were used and were typically suspended from ceilings in the center of rooms. These sensors also captured relative humidity, but over the course of the test, it did not show any significant change. External temperature, wind speed, and direction were recorded using a local base meteorological (MET) station. Internal loads were estimated by using typical electrical load and occupancy data. Building insulation properties were estimated by using building design documents, by taking samples from exterior walls, and by performing onsite inspections. Information about the protocol and results of the air barrier tests can be found in Leffel (2021).

B.3 Test results

The TDTs at Fort Wainwright Alaska (FWA) and Fort Greely Alaska (FGA) were conducted over the course of several months from January through February. Data were logged using timestamps in Alaska Standard Time (AKST), Table B-1 lists the results of the TDTs at Fort Wainwright, Alaska and Fort Greely, Alaska.

Table B-1. Thermal decay test timeline and environmental conditions.

Building	Date Tested	Test Duration	Outdoor Temperature	Wind Speed and Direction
C	Jan 09 2020	8 hours	-40 °F (-40 °C)	0 mph
A	Jan 17 2020	8 hours	-20 °F (-29 °C)	0 mph
E	Jan 18 2020	17 hours	-9 °F (-23 °C)	62 mph Gusts East
D	Jan 18 2020	17 hours	-9 °F (-23 °C)	62 mph Gusts East
B	Feb 26 2020	29 hours	-20 °F (-29 °C)	0 mph

The temperatures at FWA ranged from -21 °F to -41 °F (-29 °C to -40 °C) with virtually no wind (0 mph). The temperatures at FGA stood at -9 °F (-23 °C), but there were significant wind speeds up to 62 mph (100 kph). The tests on Bldgs. D and E at FGA started at approximately 3 p.m. on 17 January 2020 and ended at approximately 8:30 a.m. on 18 January 2020. Bldg. C at FWA was tested on 09 January 2020 starting at 8:30 a.m. and ending at 4:30 p.m. The outdoor temperatures were -40 °F (-40 °C) and rose to -37 °F (-38 °C) throughout the course of the test. Bldg. A at FWA was tested on 17 January 2020 from 8:00 a.m. to 4:00 p.m. with temperatures reaching -20 °F (-29 °C), Bldg. B at FWA was tested from 8:00 a.m. on 26 February 2020 to 1:00 p.m. on 27 February 2020 during which temperatures ranged from -21 °F to 41 °F (-29 °C to -40 °C)

B.3.1 FWA Bldg. A – Battalion Headquarters

Bldg. A showed no significant change in internal building temperature over the course of the test. The only rooms that showed any sign of thermal decay were rooms that did not have a second story above them. There are a number of reasons why this might be the case. For one,

this building was only studied for 8 hours as opposed to the longer test studies at 17 and 29 hours, respectively. However, other buildings showed a significant temperature decay after 8 hours. This can be attributed to its higher insulation values in the walls and the roof as well as its large thermal mass. This test was conducted throughout the day so the building would have experienced heat gains from solar radiation. Additionally, it should be highlighted that this building achieved LEED Silver in certification. This designation contributes to the reduction in energy demands, and it addresses envelope requirements, such as overheating, ventilation, thermal conductivity, exposed surfaces, temperature differential, airtightness, and facade orientation. With the latter requirement, facade orientation is an important consideration for construction in cold climates, as the direction of the openings and the window area proportion must be oriented in a manner that considers solar radiation and control.

B.3.2 FWA Bldg. B – Storage Warehouse

The test at Bldg. B started at approximately 8:00 a.m. on 26 February 2020. The test ran throughout the course of the day while the building was occupied by several DPW employees. Figure B-1a shows the ambient temperatures from several rooms distributed throughout the building. The test showed a relatively uniform temperature decay throughout the building, with a slight exception to the south restroom, which stayed a few degrees cooler than the other rooms throughout the test. This is likely due to the north restroom door being propped open, which allowed heat to flow freely from the plans room to the restroom leading these rooms to follow a similar pattern.

The building continued to increase in temperature several hours into the test until about 10:00 a.m. on 26 Feb for the south restroom and 4:00 p.m. on 26 Feb for the north restroom and the plans room. There are several explanations for this. One is that this building has a glycol heating system that continued to pump glycol throughout the building during the test. The residual heat stored in the glycol provided some amount of heat to the building until that heat eventually came to an equilibrium with the rest of the building. The second reason is heating from solar radiation. The plans room had several windows that allowed sunlight to enter at sunrise from the east (8:00 a.m.); also, the room was connected to a conference room via an open door with windows allowing sunlight to enter during the sunset from the west (6:00 p.m.).

The surface temperatures on the eastern and western windows spiked throughout the day as they were exposed to direct sunlight as shown in Figure B-1b. This increase in surface temperature corresponds to increases in ambient temperature. This even occurred throughout the test when the primary heat source had been removed. Heat gained from solar radiation and residual heat in the glycol heating system provided this building with extended operation time so that most rooms did not exceed the habitable threshold.

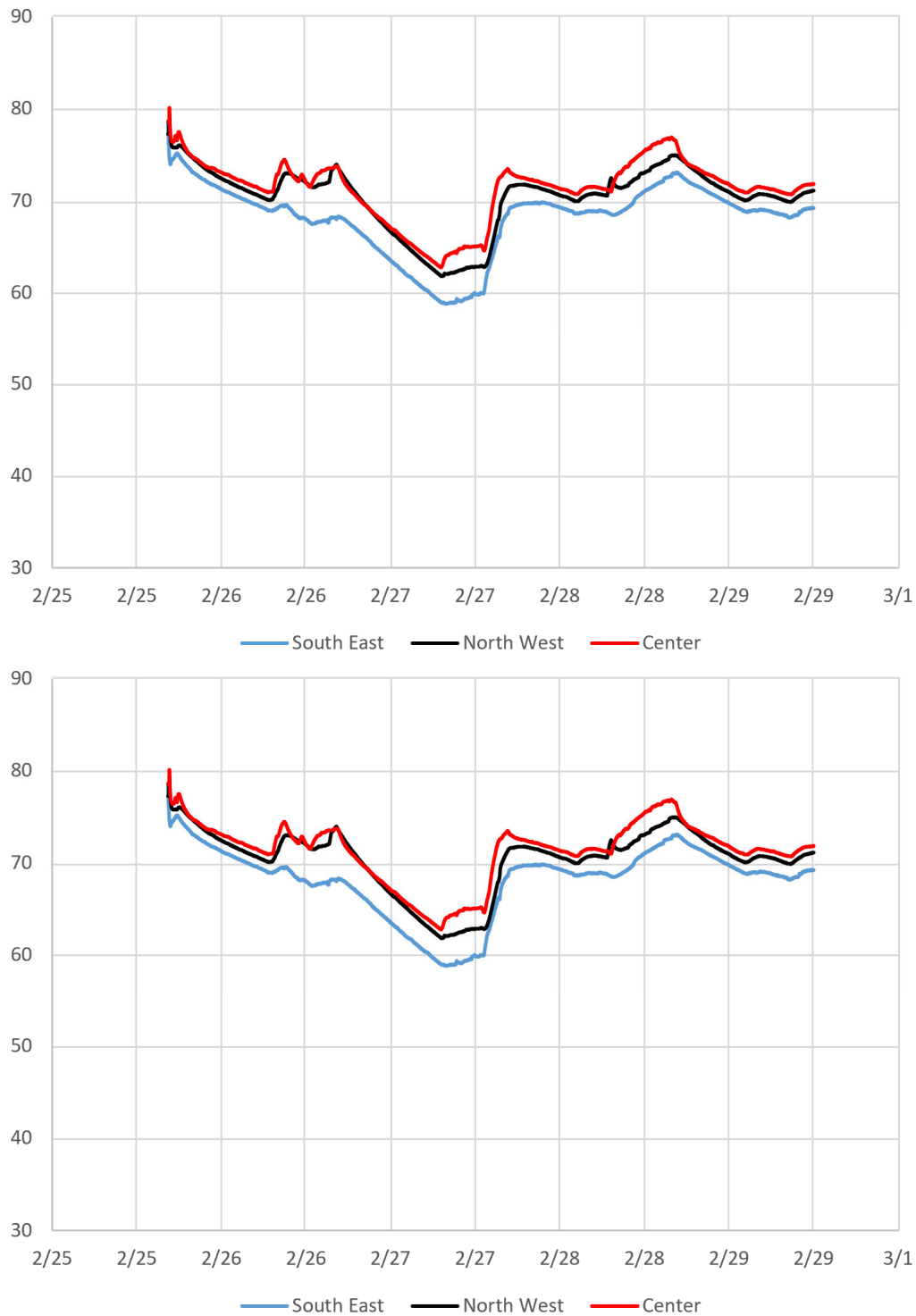

Figure B-1. Test Results from Bldg. B.

B.3.3 FWA Bldg. C – Laboratory

Bldg. C was a tri-level building with a semi-basement that was partially above and below grade. For the most part, the temperature decayed relatively uniformly and as expected, with the thermal decay rate becoming faster moving from the 2nd floor through to the basement. This was different from other building basements that were tested in that the additional insulation and thermal mass from the surrounding soil did not seem to inhibit the rate of decay, as was found in other

buildings. This is due to the large fenestration area throughout the building and especially in the basement. Additionally, there was a large open stairway column that ran from the 2nd floor to the basement, which allowed more cold air to infiltrate and sink to the bottom of the building.

Figure B-2 shows the ambient temperatures from rooms located at different heights throughout the building. Bldg. C had a server room on the second floor that continued to operate throughout the test. While temperatures in other rooms were dropping, this room actually increased in temperature throughout the course of the test. It was not clear to what extent this had an effect on the other 2nd floor rooms. In emergency scenarios internal loads such as information technology (IT) equipment, could be used to extend operation time for mission critical staff, but this would be limited to the room in which the equipment is housed.

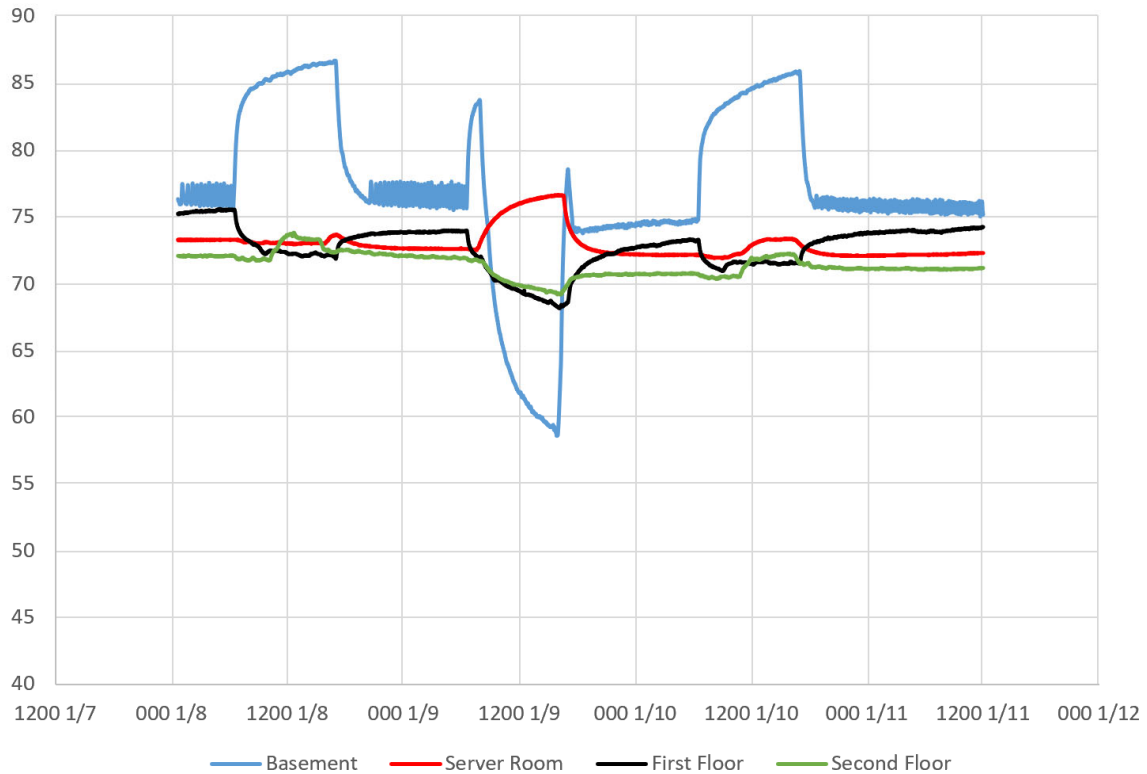

Figure B-2. Bldg. C, ambient temperatures throughout the building.

B.3.4 FGA Bldg. D – DPW Building

The tests on FGA started at approximately 3:00 p.m. on 17-Jan and ran until 8:30 a.m. on 18-Jan. Bldg. D did not decay uniformly as the buildings at FWA did. Room 104 approached the critical temperature for the thermal decay test. Rooms 104 (garage bay) and 103 (wood shop) were connected by an open hallway and had air flowing freely between the two rooms. Despite Room 103's pre-test temperatures being approximately 10 °F (5.6 °C) lower than rooms 102 (office) and 104, its rate of decay was slower. Rooms 102 and 103 were on opposing corners of the building and air was not able to flow freely between the rooms. Rooms 102's rate of thermal decay was faster than that of Room 103 despite the fact that both had a similar insulation properties and Room 103 had a larger fenestration area.

The graphs in Figure B-3c may be used to compare the ambient temperatures for three different rooms in Bldg. D. Room 102 decayed significantly faster than Room 103. This is due to Room 102

being directly in the path of 60+ mph (97+ kph) easterly winds experienced at Fort Greely during the night of the test, as Room 102 was located on the south east corner of the building. This caused a positive pressure on the side of the building that Room 102 was located in and a negative pressure on the side that Room 103 was located in. This set up a pressure gradient throughout the building causing warm air to exit the building on the west side and cold air to enter the building on the east side. This accelerated air infiltration in Rooms 102 and 104. In addition to the wind effect, Room 104 appeared to have less insulation than other rooms as this section of the building was built using different materials than those used in the rest of the building, i.e., metal sheeting.

Building materials with a larger thermal mass will release energy stored in the thermal mass during a thermal energy disruption, thereby inhibiting the rate of thermal decay. The data in Figure B-3 (a, b) may be used to compare two rooms with different building materials and different insulation values. Figure B-3a shows the ambient temperature (blue) follows the exterior wall (CMU/EIFS) surface temperature (red) closely but remains colder than the interior wall surface temperature (yellow). This is because the exterior wall resists the change in outdoor vs. indoor temperature. Also, the interior wall is not directly exposed to the cold outside air and is able to retain more of its stored thermal energy causing a lag in temperature behind the exterior wall and ambient temperatures. This is important for building envelope design because, while interior walls may not need to be built from heavier materials to maintain structural integrity, it may be beneficial for thermal energy resilience.

Figure B-3b shows that building materials with less thermal mass and insulation values (metal sheeting) the ambient temperature deviates significantly from the surface temperatures. This causes the ambient temperature to lag behind the surface temperature, as the metal sheeting is less resistant to changes in temperature. This ultimately leads to a faster rate of thermal decay and a shorter maximum time to repair.

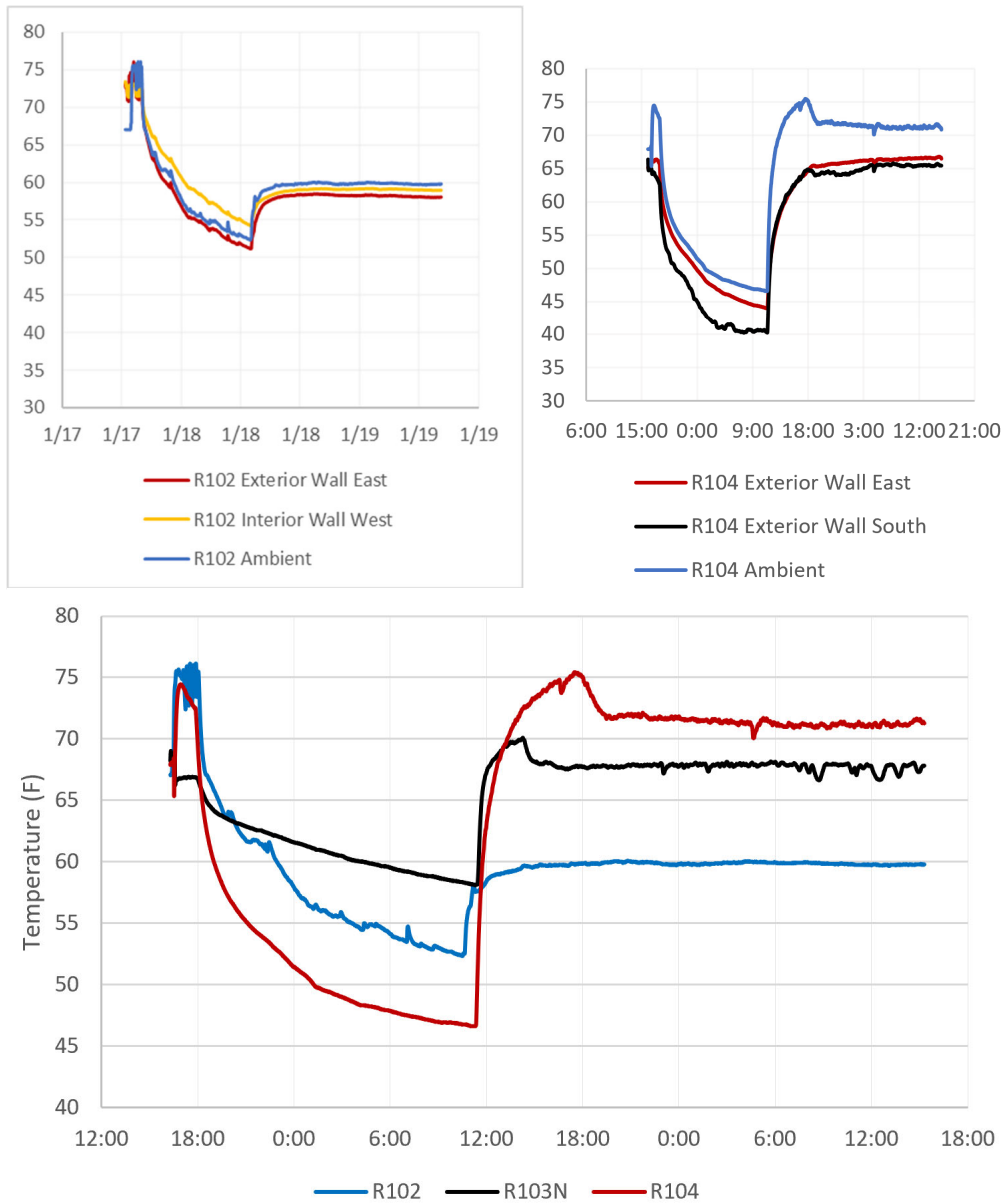

Figure B-3. Test results from FGA Bldg. D.

B.3.5 FGA Bldg. E – MWR Building

Bldg. E is separated into three sections isolated from one another. From east to west, the main rooms in each of these sections are Rooms 125, 100, and 108. Underneath section 100 is a fully below-grade basement, which is composed of two rooms (Rooms 001 and 002). Room 001 is the mechanical room and entrance for the steam pipes. The two rooms were separated by a wall with an open doorway. Room 002 was located near the staircase to the basement, which allowed for cold air to sink to the basement. Both rooms did not reach the critical threshold, despite being in the basement. The absence of direct access to the outdoor temperatures allows the thermal mass of the CMU’s and soil to insulate the basement.

Over the course of the 17-hour test, Section 100 had the longest projected operation time. One reason for this is that Section 100 is shielded on both east and west sides by Sections 125 and 108, respectively. Another reason is the thermal energy rising from the basement. The thermally saturated foundation and surrounding soil acted as thermal battery, dissipating heat over the

course of the test. Sections 108 and 125 are located on opposing corners of the three-part building with Section 100 being located in the center. Section 125 had the most dramatic thermal decay curve and was located on the east side, directly in the path of the wind. Section 125 also had the largest fenestration area with large windows on the north and south side. Wind was a significant contributor to the thermal decay rates in FGA. The effects of wind can be seen in Figure B-4c, which shows the difference in surface temperatures between the southeast and northwest corners of Bldg. E. At the start of the test, the southeast corner was approximately 5 °F (2.8 °C) warmer than the northwest.

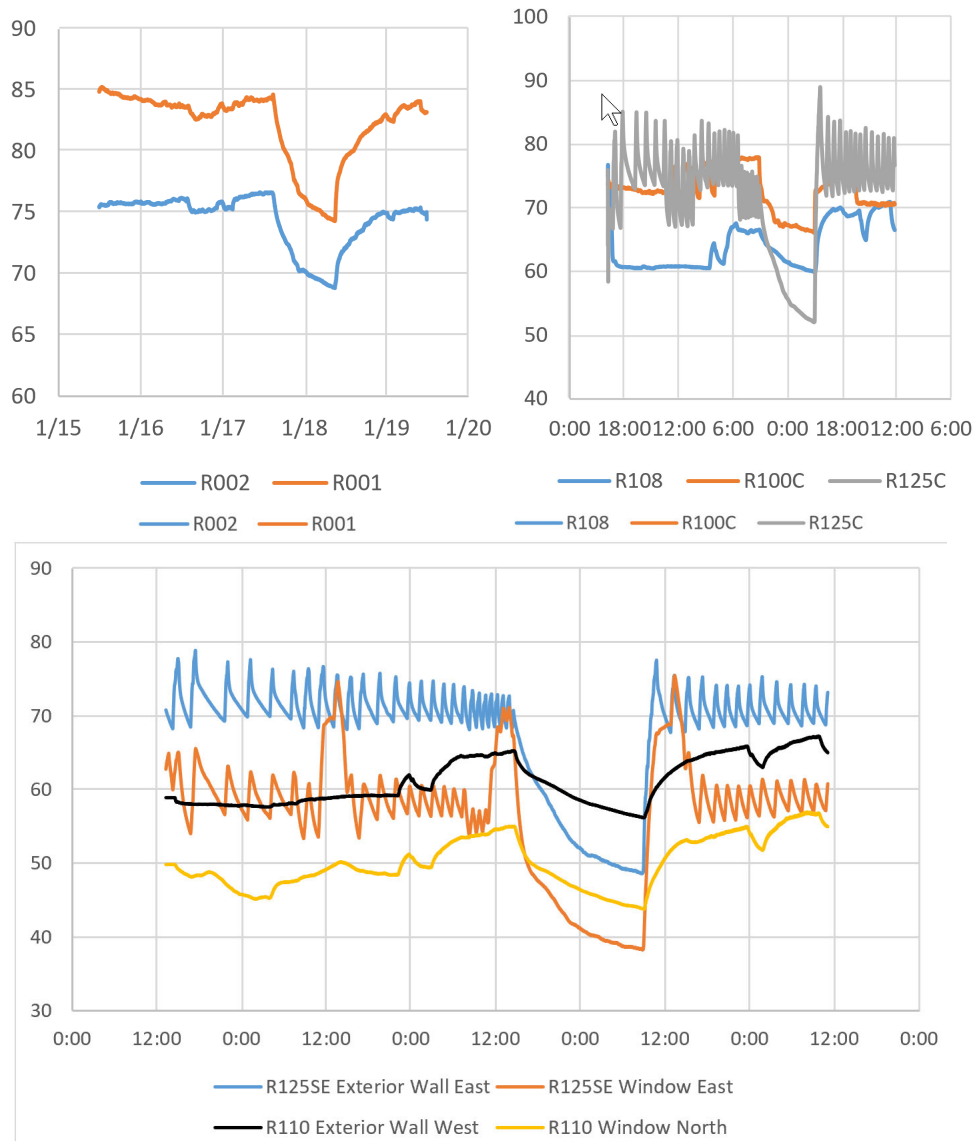

Figure B-4. Test results from FGA Bldg. E.

B.4 Building models

B.4.1 Objectives

The objectives of the studies described below are to produce a reliable building model that can be used to predict and identify the maximum allowable time available to correct an energy supply problem in mission critical facilities built using different facility archetypes (building

mass, insulation characteristics), and air leakage rate. To show the building model reliability, the five buildings described and tested in the previous sections of this appendix are developed using all the data available from drawings, specifications, retrofits, and building walk-through for the model inputs. These models were simulated and then the failure mechanism was specified and matched to the test procedure and replicated in the equipment schedules with the building model. The model failure temperatures are compared to the TDT results to determine how reliable the results are for a conservative prediction of the maximum time available to repair for other buildings. In most cases, the TDT was terminated long before the buildings reached the 40 °F (4.4 °C) threshold, but in the models, a failure period of ~5 days from 8 a.m. on Friday was sustained and heating was restored at midnight Wednesday morning. The slope and final temperature can be determined from the simulated model. Then the amount of time was observed when the building reached the heating setpoint. For comparison, the last part of the appendix explores some properties of the building capacitance, insulation levels, and air tightness. EnergyPlus version 8.9, a whole-building hourly energy model with Design Builder as the interface, was used to produce all of the simulated model data in this appendix, which were compared to the TDT test results.

B.4.2 Buildings modeled

B.4.2.1 Fort Wainwright

B.4.2.2 Bldg. 3002

Bldg. 3002 (Figure B-5a), which resides on south post at Fort Wainwright, Alaska, was constructed in 2016. The building consists of administrative space, areas for special functions, and classrooms. The 20,136 ft² (1,872.6 m²) building is constructed with thermal envelope consisting of insulated metal wall panels of a minimum R-30, metal roof assembly at a minimum R-60. The building achieved a Gold Certification for Leadership in Energy and Environmental Design (LEED) Silver certification. The structure consists of two stories on the west side and a single story on the east side. The building's orientation has the entrance facing west.

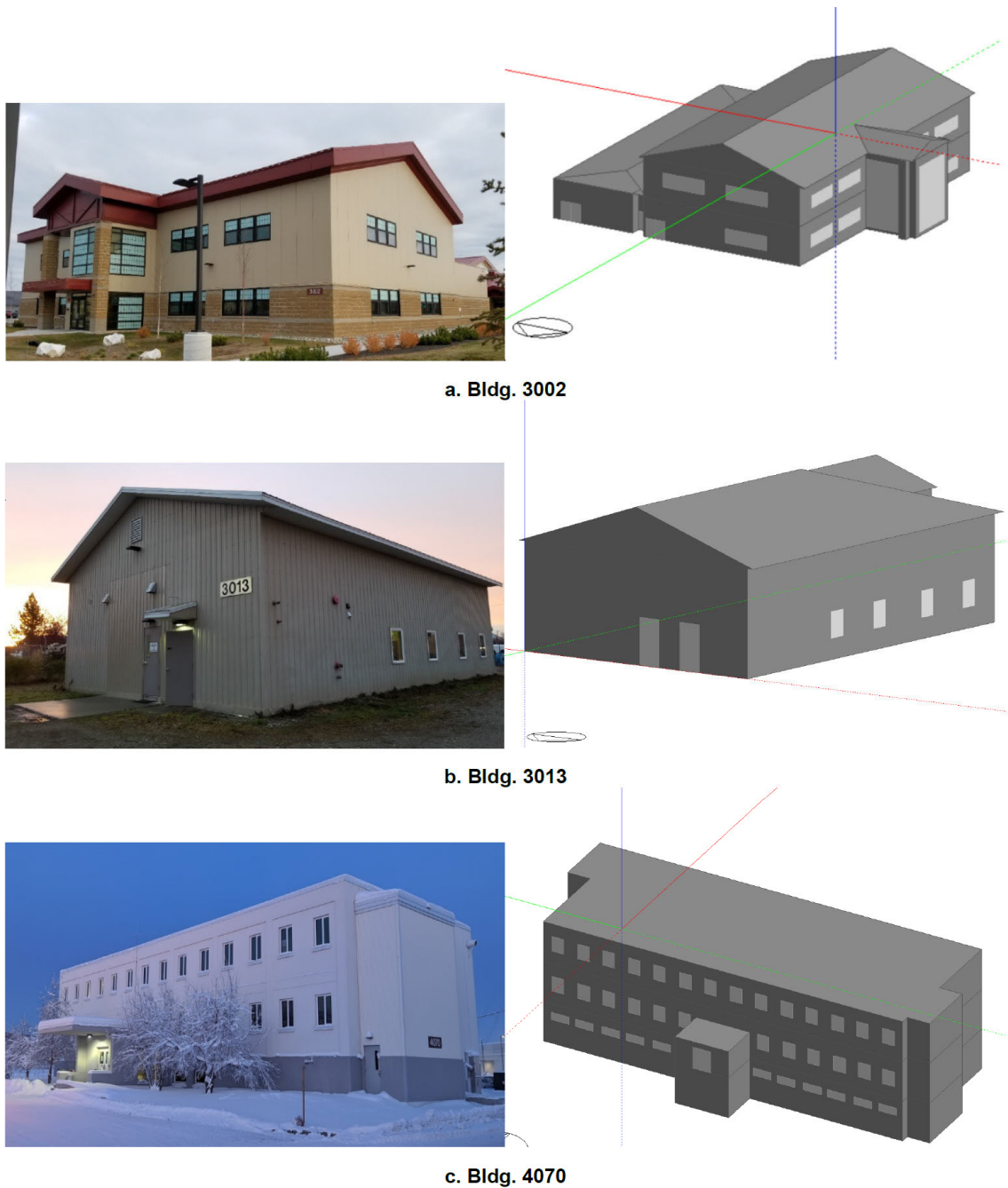

Figure B-5. Fort Wainwright Bldgs. 3002, 3013, and 4070, photo and model representations.

B.4.2.3 Bldg. 3013

Bldg. 3013 (Figure B-5b) resides on south post at Fort Wainwright, Alaska. The building houses primarily office and meeting spaces but also has an unconditioned storage area. Bldg. 3013 was constructed in 1999. The facility has a wooden frame and metal siding. The building has an eave height of 16 ft (4.9 m) while the internal ceiling drop is 9 ft (2.7 m) from the floor. The facility has a total of six windows. Two of these windows are on the eastern wall of the facility, while the remaining four are on the westernmost wall. All windows are of the same construction, with widths of 36 in. (91 cm) and heights of 48 in. (1.22 cm) the windows are double-paned with aluminum frames and low emissivity coatings. The walls have a total R-value of approximately 26

while the roof has a total R-value of approximately 30 (these were not known). The building also has low intensity slab heating in the floors with mechanical ventilation for fresh air.

B.4.2.4 Bldg. 4070

Bldg. 4070 (Figure B-5c) is located at Fort Wainwright, Alaska. The building houses office and meeting spaces, medical examination facilities, and medical laboratories. Bldg. 4070 was constructed in the 1950s and recently had a major renovation. The facility has two floors plus a basement. The above-grade walls consisted of an 8-in. (20-cm) layer of concrete with standard 16-in. (41-cm) furring that allowed for 2 in. (5 cm) of fiberglass insulation and ½ in. (1 cm) of gypsum board. During a later update to the facility, 4 in. (10 cm) of expanded polystyrene (EPS) was added to the outer most surface of the building. According to calculations performed using DesignBuilder, this construction gives the facility walls an R-value of approximately 29.7.

The basement walls had a similar construction. However, the initial concrete layer was 1 in. (3 cm) thicker than that of the above-grade walls. A portion of the basement walls remained above grade to allow for the installation of windows. There were 21 windows of this type, 12 on the western face of the building and nine on the eastern face. These windows were approximately 6 ft (1.8 m) long and 2.5 ft (0.8 m) tall. The windows for the second and first floor of the building differed from those for the basement. Most of these windows are located on the east and west faces of the building with the north and south faces containing only one window each. Windows of this type were approximately 4 ft (1.2 m) wide and 5 ft (1.5 m) tall with triple glazing. In total, 42 of these windows were present on the first and second floors.

B.4.3 Fort Greely

B.4.3.1 Bldg. 603

Bldg. 603 (Figure B-6a) resides on south post at Fort Greely, Alaska. The building was once used as a multipurpose warehouse and workshops but is now outfitted with office space, some workshops, and an unconditioned basement. Constructed in 1955, Bldg. 603 is a Department of Public Works building. The two-story building uses CMU in the interior wall construction with an EIFS exterior building construction. There are a variety of windows and sizes, with entry and overhead garage doors. The roof on the pre-existing structure is flat, and the building addition has a gabled roof.

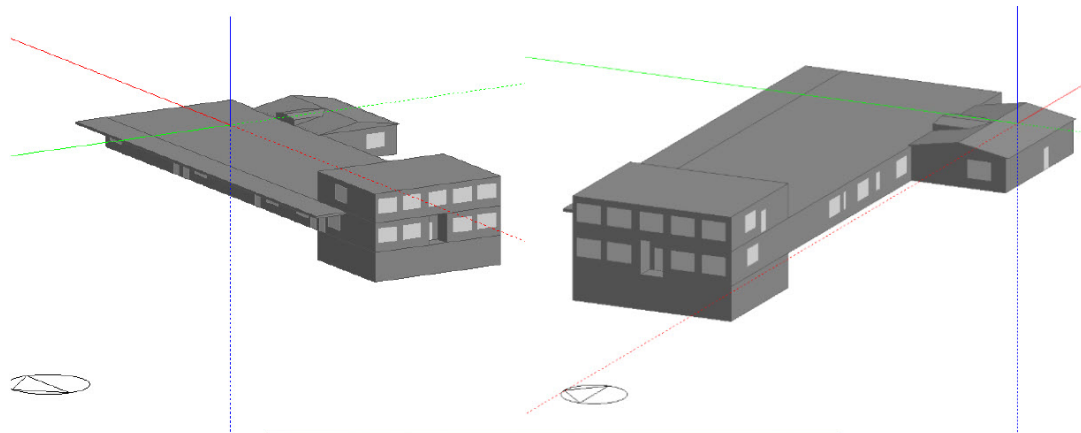

a. Bldg. 603

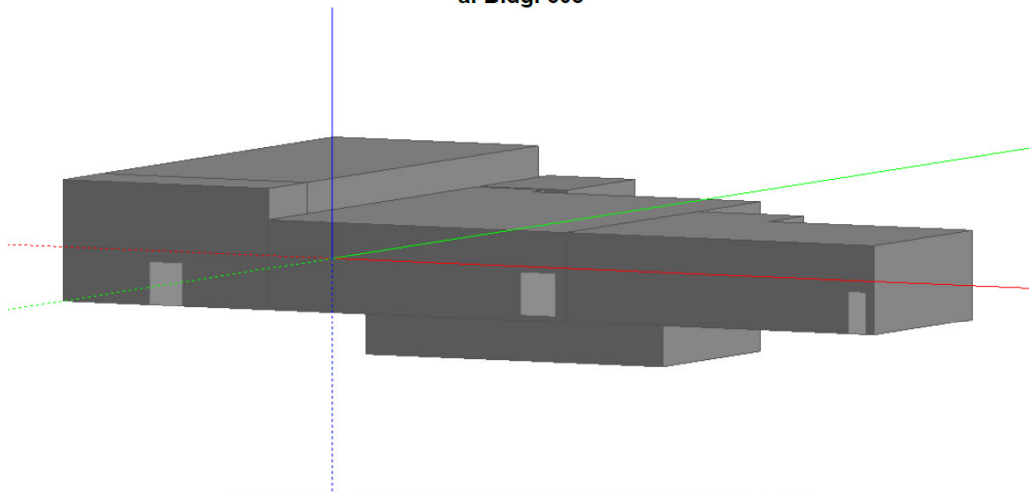

b. Bldg. 650

Figure B-6. Fort Greely Bldgs. 603 and 650, photos and model representations.

B.4.3.2 Bldg. 650

Bldg. 650 (Figure B-6b) is located at Fort Greely, Alaska. The building houses a variety of recreational facilities including a theater and a wood shop. Bldg. 650 was constructed in the 1950s and was later expanded. The building also had updates to the building envelope. There are very few windows in Bldg. 650. Per the window submittal document, these windows possess a triple glazing and an aluminum frame. Walls consist of 8-in. (20.3-cm) concrete block with 2 in. (5 cm) of batt insulation and ½ in. (1.3 cm) of gypsum board.

B.5 Building air leakage

The air infiltration rate was determined using Alaska Thermal Imaging² and results were determined for each building. The infiltration study performed on the facility provided an air leakage rate in units of CFM₇₅/ft², which must be converted for use in the DesignBuilder software.³ The software only accepts values in air changes per hour (ACH) as the input for modeling infiltration.

The following shows the conversion process for Bldg. 3013. The study provided an initial air leakage rate of 0.095 CFM₇₅/ft². To convert from CFM₇₅/ft² to ACH, the provided value first had to be converted to cubic feet per minute (CFM) at standard pressure. This was done by first multiplying the initial value by the six-sided area of the facility and then converting from CFM₇₅ to CFM at standard pressure. These operations were performed as follows:

$$\frac{0.095 \text{CFM}_{75}}{\text{ft}^2} * 8488.8 \text{ft}^2 = 806.4 \text{CFM}_{75}$$

$$\text{CFM} = \text{CFM}_{75} * \left(\frac{5}{75}\right)^{0.65} = 0.172 * \text{CFM}_{75}$$

$$\text{CFM} = 0.172 * \text{CFM}_{75}$$

$$\text{CFM} = 0.172 * 806.4 \text{CFM}_{75} = 138.7 \text{CFM}$$

These conversions provided a value of 138.7 CFM at standard pressure. From here CFM would be converted into ACH using the relation:

$$\frac{ac}{h} = 60 * \frac{\text{CFM}}{V_{tot}} \quad (\text{B-1})$$

where V_{tot} is the total volume of conditioned room in ft³. Carrying forward with the calculation:

$$\frac{ac}{h} = 60 * \frac{138.7 \text{CFM}}{38400 \text{ft}^3} = 0.217 \text{ACH}$$

The final value of 0.217 ACH was used for the simulation of Bldg. 3013. Table B-2 summarizes the rest of the results.

² Alaska Thermal Imaging, Inc, Palmer, Alaska, http://alaskathermalimaging.com/Home_Page.html

³ CFM₇₅ is air leakage rate in cubic feet per minute at 75 Pa, i.e., the static pressure between the building's interior and the buildings ambient; and CFM is air leakage rate in cubic feet per minute at standard pressure and EqLA75 is Equivalent Leakage Area at 75 Pa.

Table B-2. Simulation results.

FTG & FTW ABT-2019	Year of Const.	Bldg. Const. Type	Six-Sided Area (ft ² /m ²)	CFM ₇₅ / ft ² (m ³ /h.m ²)	EqLA ₇₅ (ft ² /m ²)	ACH
FTW 3002	2016	IMP	39,822 / 3,703.5	0.208 / 3.744)	5.7 / 0.53	0.342
FTW 3013	1999	Wood Framed	8,488.8 / 789.5	0.095 / 1.710	0.5 / 0.047	0.217
FTW 4070	1950s	CMU Upgraded	Not Available (NA)	NA	NA	NA
FTG 603	1955	CMU/Concrete/EIFS	32005.6 / 2,976.5209	0.155 / 2.790	3.3 / 0.307	0.399
FTG 650	1955	CMU/Concrete/EIFS	28,501.6 / 2,650.6489	0.146 / 2.628	2.8 / 0.260	0.261

B.6 TDT process and objective

During the TDT, the primary heat source to a building is removed and researchers monitored how long and how fast the buildings temperature decayed. The goal of the test was to document the building’s behavior and to collect the needed baseline data to calibrate and validate models for thermal energy decay. A secondary purpose of these tests was to establish a TDT protocol to ensure test consistency and to streamline the process for the tests at Fort Wainwright and Fort Greely (Oberg et al. 2021).

B.7 Heating failure simulations methodology and TDT results comparisons

Air temperature is essential for the evaluation of thermal comfort and energy consumption. The interior temperatures mostly depend on the construction, air tightness, factors in efficiency, insulation, internal loads, and occupancy.

The failure test conducted in Part I of this appendix was compared to the building model data. It is important to determine a reliable model for buildings so the model can then be applied to other buildings at other locations to determine the maximum time to repair to ensure the safety of building’s components, materials, and equipment.

Thermal degradation test protocol and processes were developed and applied in the 2019-2020 winter season to buildings at Fort Wainwright Alaska (W) and Fort Greely Alaska (G):

- W.4070.T1: Bldg. 4070 Dec 12th, 2019 – 8-hour trial run at 10 °F (-12.2 °C).
Trial run for testing the protocol and data collection tools.
- W.4070.T2: Bldg. 4070 Jan 9th, 2020 – 8-hour test at -40 °F (-40.0 °C).
- W.3013.T1: Bldg. 3013 Jan 14th, 2020 – 8-hour test at -20 °F (-28.9 °C).
- W.3002.T1: Bldg. 3002 Jan 17th, 2020 – 8-hour test at -20 °F (-28.9 °C).
- G.650.T1: Bldg. 650 Jan 18-19, 2020 – 19-hour test at -40 °F (-40.0 °C).
- G.603.T1: Bldg. 603 Jan 18-19, 2020 – 19-hour test at -40 °F (-40.0 °C).
- W.3013.T2: Bldg. 3013 Feb 26-27, 2020 – 25-hour test at -20 °F (-28.9 °C).

The following sections compare the failure tests done at each building.

B.7.1 Fort Wainwright

B.7.1.1 Bldg. 3002

Bldg. 3002 heat failure test was conducted on January 17, 2020 for an 8-hour test at -20 °F (-28.9 °C). The buildings mechanical room in located on the north side of the first floor. The failure began and 8 a.m. and ended approximately 4 p.m.

First floor

The sensor was placed on the floor, mid-height, ceilings, and windows in general office areas, classrooms, hallways, and entry areas. The sensor data shows constant air temperature during the experiment, whereas the back classroom showed a slight decline in air temperature despite having a heated floor. This second floor does not extend over the classroom area on the first floor.

Second floor

The sensors on the second floor of Bldg. 3002 had the same placement; they were located in the general-purpose areas (open office space), office, and entry areas. The second floor does not have dedicated classrooms and is mostly individual offices. The experiment was conducted over the same amount of time on the same day at the first floor. Figure B-7 shows multiple sensors that displayed inconsistent air temperatures (Sensor 7446 located on mid-room on a desk and Sensor 10694 located on mid-room, mid-height); this could be due to changing temperature on surface areas or to sensor’s proximity to a vent where mechanical ventilation was still causing air movement.

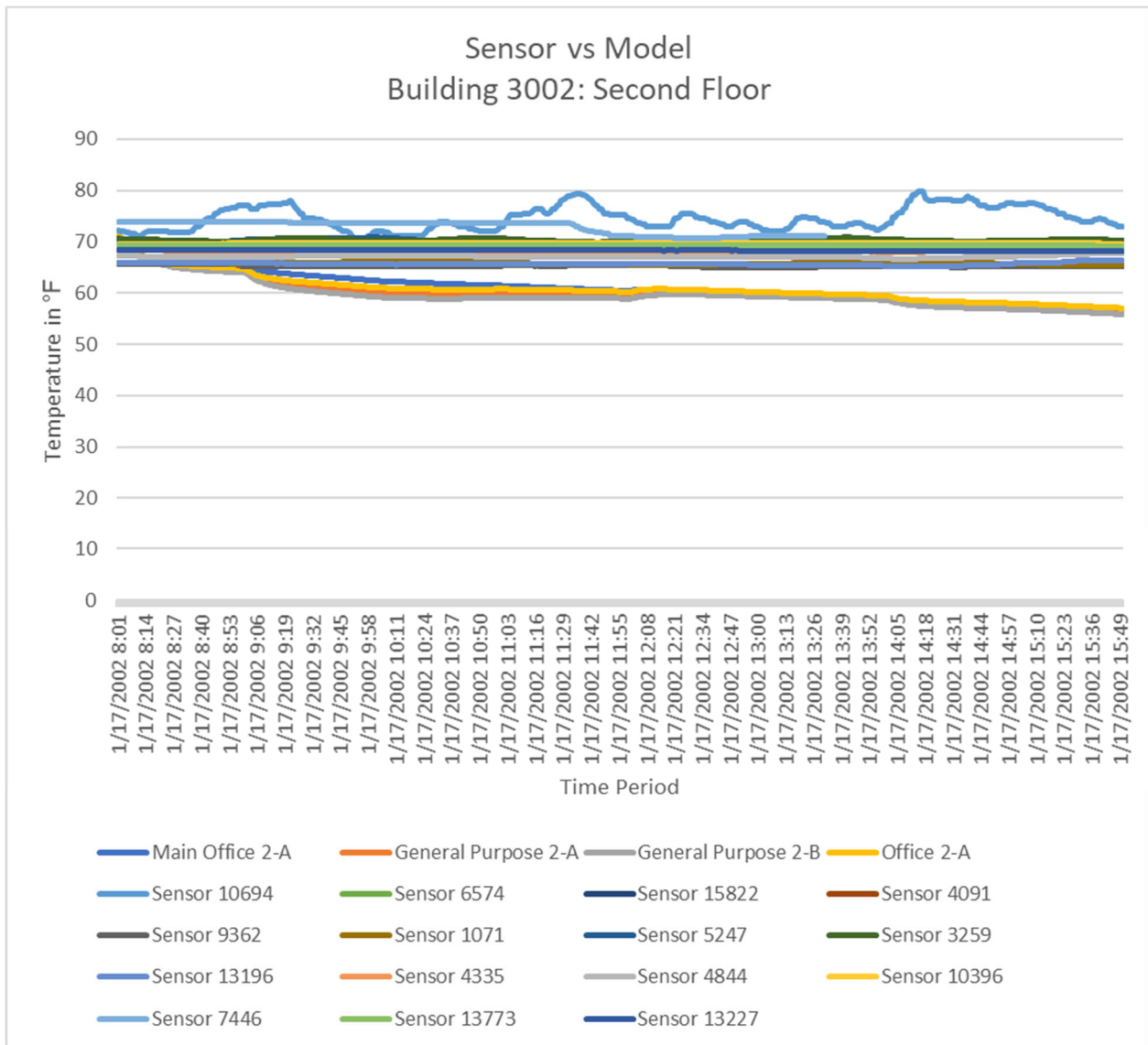

Figure B-7. Bldg. 3002 sensor and model comparison.

The model and sensor temperatures did reflect a decrease in the air temperature, but the model showed that the temperature reached the mid-50s °F (mid-teens °C). The air temperature for the model data could indicate infiltration and heat loss through the spaces pitched roof system.

The sensors and the model data show a good comparison, and the models project a slightly lower building temperature, which is a conservative prediction.

B.7.1.2 Bldg. 3013

Bldg. 3013 is a single-story building with a floor area of 2640 ft² (245.5 m²). The building has two arctic entries on the north and south side. The mechanical room has a separate entrance on the north side without an arctic entrance. The test began on Wed Feb 26th at 8 a.m. AKST and ended on Thurs Feb 27th at 1:10 p.m. AKST. An overnight test was scheduled for the evening of Wednesday Feb 26th through Thursday Feb 27th. The steam was disabled to Bldg. 3013 at 8 a.m. The HVAC air handlers were disabled at the same time. The glycol pumps were left enabled to enable comparison to the W.3013.T1 test scenario. The 25-hour test ended Thursday Feb 27th at 1 p.m. when steam was restored and HVAC re-enabled.

What can be seen with the heating failure at 8 a.m. is that, for the first 8 hours of the day with the otherwise normal operations of the building and the light structure with a radiant floor, there is a slow temperature decay. Then when the business day ends and the outdoor temperatures drop, the building starts decaying. The data shown in Figure B-8 may be used to compare the sensor in the main office area at mid-height temperature and the EnergyPlus building model over the same time period.

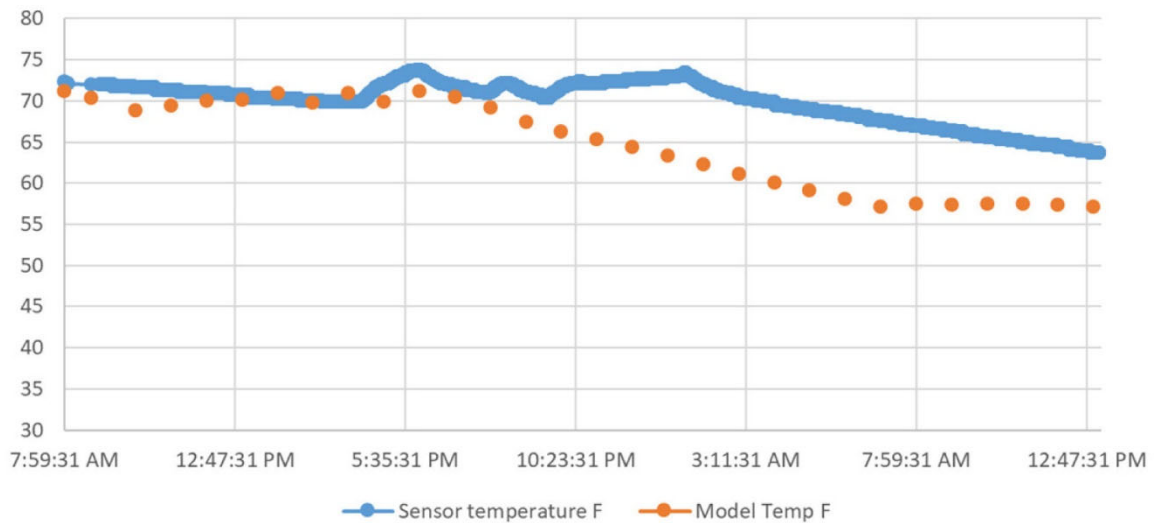

Figure B-8. Bldg. 3013 heating failure results shown for 18 hours; sensor data top and model data bottom.

The data in Figure B-9 are in good agreement with the model and the sensor data. From 8 a.m. to 5 p.m., the temperatures are very similar. During the evening there seems to be a heat input to the building that is not in the model. But once the temperature decay starts, the slopes are very similar. Overall, the model should not under-predict the temperature decay, it is better to have the model predict that the building is getting colder sooner than the actual data. This way the prediction to when intervention is necessary happens before building damage occurs and will be a conservative estimate and a more reliable to use.

B.7.1.3 Bldg. 4070

The scenario simulated a heating failure on a Friday morning that was restored on the following Wednesday. During the weekend failure period, the simulated building sank to temperature of 38 °F (3.3 °C) before rising slightly during its occupied periods on Monday and Tuesday. A minimum temperature of 33 °F (0.6 °C) was reached early Wednesday morning at 2 a.m.

Two TDTs for Bldg. 4070 were performed. The first of these tests took place in December of 2019. Outside temperatures averaged 10 °F (-12.2 °C). This test was largely used to establish testing protocols. The second TDT occurred in January of 2020. During this test, outdoor air temperatures average -40 °F (-40.0 °C). The test occurred for approximately 8 hours between 8 a.m. and 4 p.m. This test will be used to compare the results of the model built for Bldg. 4070 and run at -40 °F (-40.0 °C).

First floor

The TDT required the placement of sensors throughout the building. For comparison, it was optimal to place sensors near the center of the wall. Sensor 6761 was one such sensor. Records show that this sensor was placed ~5 ft (~2 m) from the floor atop of a metal shelf and was against an interior wall. It was determined that a second sensor placed on the first floor of Bldg. 4070 would also be useful for analysis; Sensor 8138 was located near an interior wall ~4 ft (~1.2 m) above the floor atop a wooden shelf.

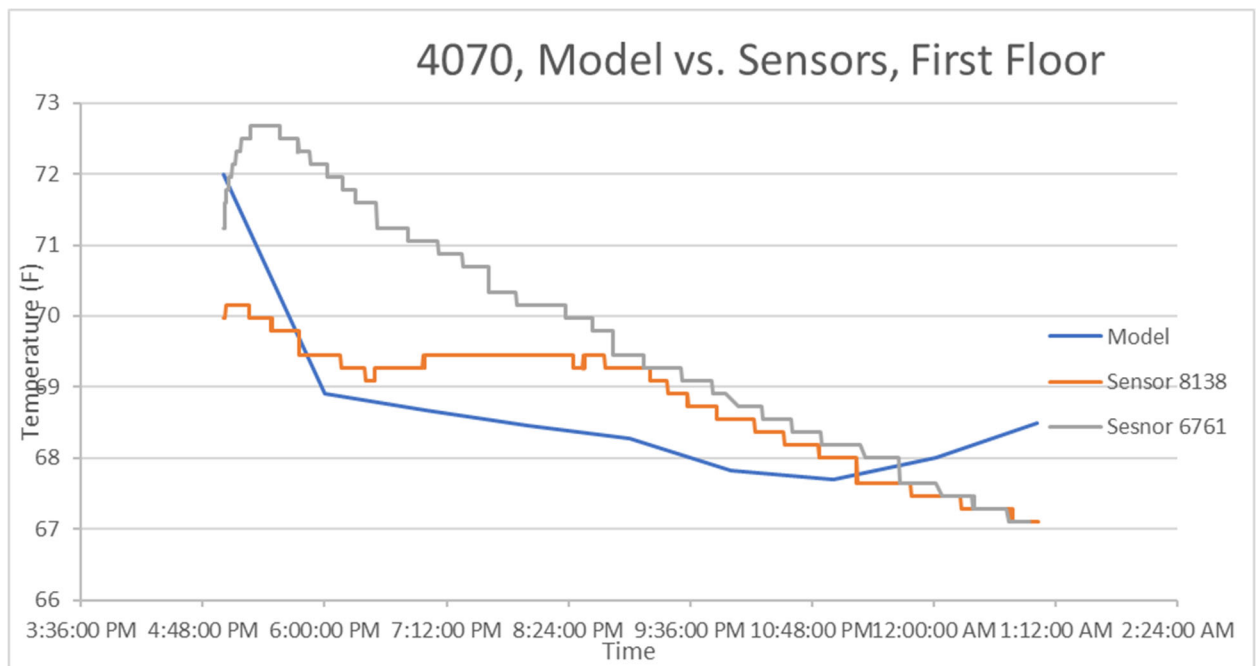
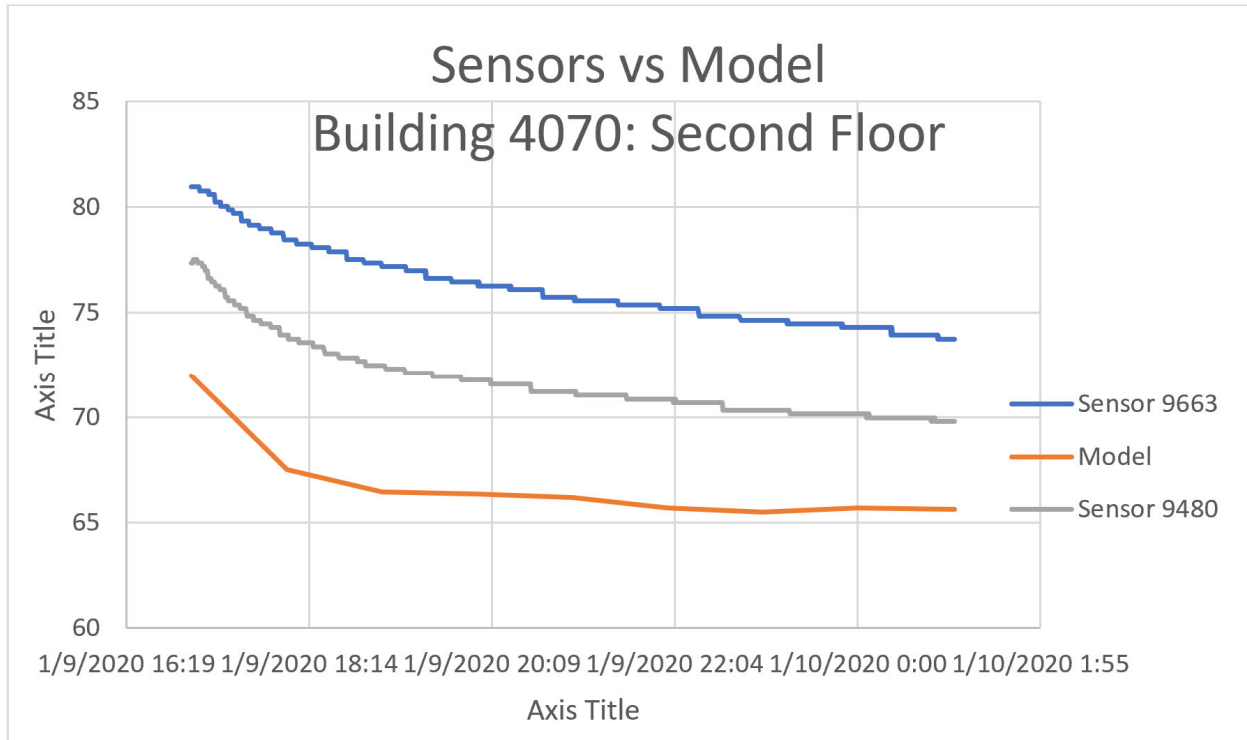

Figure B-9. Bldg. 4070 first floor heating failure results.

Both sensors reach a temperature minimum of 67.1 °F (19.5 °C) while the building model for the first floor reached a minimum of 67.7 °F (19.8 °C) in 8 hours. Note that, unlike the sensors, the model temperature begins to trend back upward. However, the increase accounted for only 1 °F (0.56 °C) of change across the trend. Sensor 8138 experiences a plateau that is not seen in the other sensor and it can also be observed the most temperature decay seems to occur in the latter 4 hours. This also indicates a level of capacitance. For most of the dataset, the model remains below the actual building in temperature. This indicates it may be reliable in estimating temperature, but the trend back upward is a load that was not present in the actual building.

Second floor

Figure B-10a shows that, as with the first floor, two sensors were chosen for the second floor of Bldg. 4070 to compare with the model data. Sensor 9663 was placed near an exterior wall and was approximately 4 ft (1.2 m) from the ground on top of a shelf. Sensor 9480 was placed near an interior wall. Like the previous sensor, it was approximately 4 ft (1.2 m) off the ground and was on top of a shelf.



a.

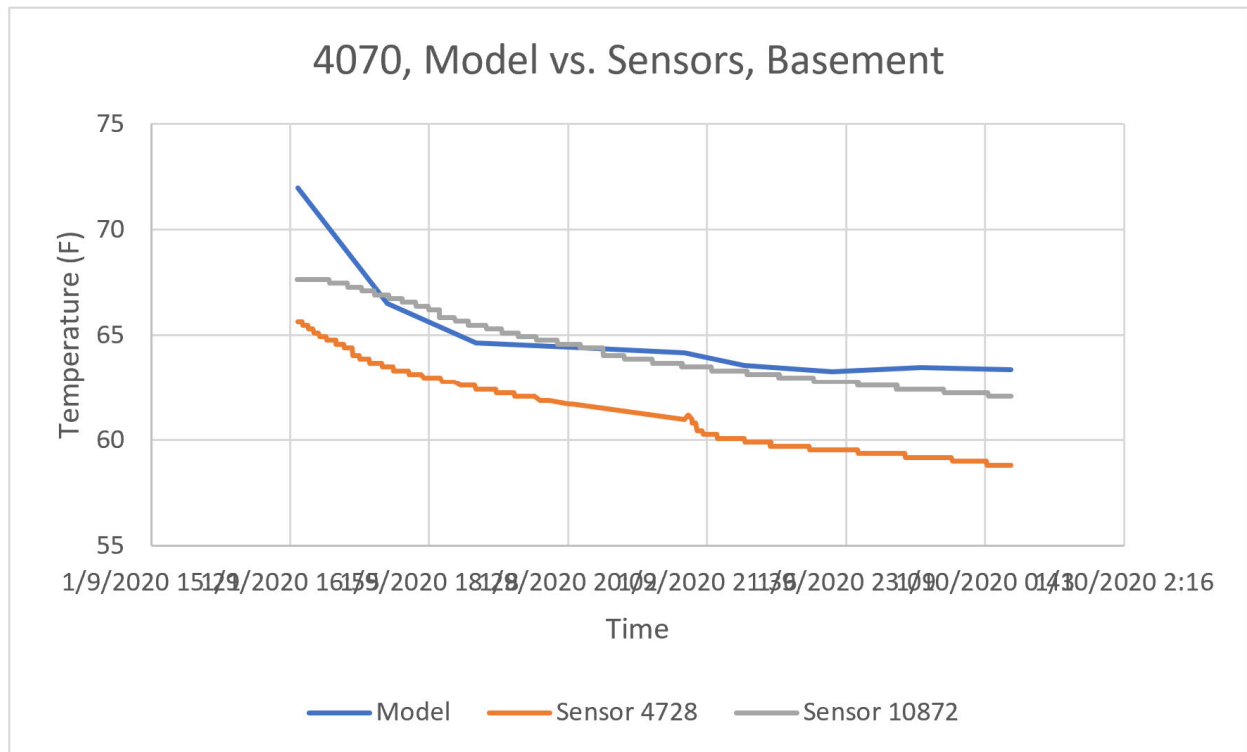

b.

Figure B-10. Bldg. 4070 second floor (a), and basement (b) heating failure results.

The curves for each of the sensors as well as the model seem to follow the same general shape. What is most of note is the gap between each curve, or the starting point. In general, the sensor location in the actual facility had a warmer starting temperature than the model, with the model showing the setpoint at the thermostat. While the model began the decay at 72 °F (22.2 °C), Sensor 9480 began at 77 °F (25.0 °C) and Sensor 9663 at 81 °F (27.2 °C). Although there is a temperature gap between the model and the sensor data because the model never exceeds the actual temperature, it may still be useful in predicting resilience. The model shape shows the behavior of the building temperature decay is captured, while a real building will not be isothermal for all sensor locations. The temperature trend of the model would allow appropriate action to be taken as a prediction.

Basement

In Figure B-10b, two sensors were selected to compare to the model data. Sensors 4728 and 10872 were each placed near interior wall atop shelves. Both sensors were approximately 4 ft (1.2 m) above the floor.

As with the second floor, the sensors show that this area is not isothermal, as expected. The model data seems to follow Sensor 10872 closely, with temperatures from the model being slightly above those of the Sensor. The model starts out at a temperature of 72 °F (22.2 °C) while the sensors begin nearer to 66 °F (18.9 °C) at those sensor locations. The temperatures plotted on this zoomed in scale show that the model follows the trend of the collected data well.

B.7.2 Fort Greely

B.7.2.1 Bldg. 603

On Friday, January 11, employees arrived onsite for a typical business day, in which they would use lighting and other office equipment in the normal course of business. Without the heating system, the air temperature reached freezing condition in the 23rd hour with operative air temperatures hovering at 38 °F (3.3 °C). On Monday, January 14, occupants endured an 18 °F (10 °C) difference from the outdoor air ranging 6 °F to 10 °F (-14.4 °C to -12.2 °C) and an operative temperature between 23 °F and 29 °F (-5.0 °C and -1.7 °C).

Without the heating system, the air temperature does not reach above 40 °F (4.4 °C) until 8 a.m.; these conditions last until 7 p.m. The air temperature reaches a freezing condition in the 26 hours. This means that the restoration would need to happen within the first 8 hours of the building heat failure, to restore the building to temperatures above 40 °F (4.4 °C) within 5 hours.

The data in Figure B-11 may be used to compare Sensor 104 and the DesignBuilder Simulation Model in conditions that occurred after 19 hours of the heat failure experiment with ambient temperatures of -40 °F (-40.0 °C). The initial temperature for the sensor data shows a temperature increase at the beginning of the experiment. Model data started with the interior temperature setpoint of 72 °F (22.2 °C) at 4 p.m. The sensor data compared to the model data indicates that the additional space of Bldg. 603 would react to the decay in the same fashion. The building decay would affect the space temperatures, but not in the critical range for damage to the building. The recovery time happens quickly for both cases.

The Mezzanine space located on the second floor on the northwest side of the building showed a gradual decline in the air temperature in the space during -40 °F (-40.0 °C) outdoor air temperature, but the model indicates a greater decrease in air temperature over the time

period. Air infiltration, exterior wall, or wind speed could be the reason for the difference between the model and the sensor data.

The Front Entry of Bldg. 603 faces west. The sensor and model data show declines in the air temperature once the heat failure experiment commenced. The air temperatures are similar for both sensor and model, but the model indicates a rapid decline in air temperature, reaching the upper 40s (°F) (4.4°C - 9.4°C) temperatures. The model would suggest that heat restoration would have to be implemented within the first 8 hours on January 19th.

B.7.2.2 Bldg. 650

The model represented in Figure B-12 shows an almost immediate, sharp drop in building air temperature. Within the first 2 hours of failure, the temperature falls to 30 °F (-1.1 °C). This would indicate that the building would be almost immediately inhabitable and damage to equipment would occur quickly as well. A 19-hour TDT was conducted for Bldg. 650 on January 18 and 19 of 2020. Two sensors were selected for comparison of the model data. Sensor data was compared to the average data for the entire facility. The test was conducted with outdoor temperatures near -40 °F (-40.0 °C).

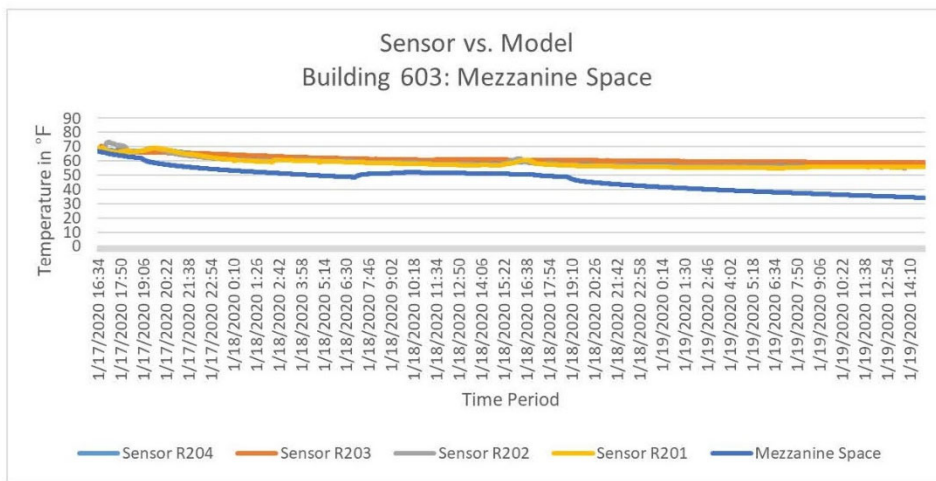

a.

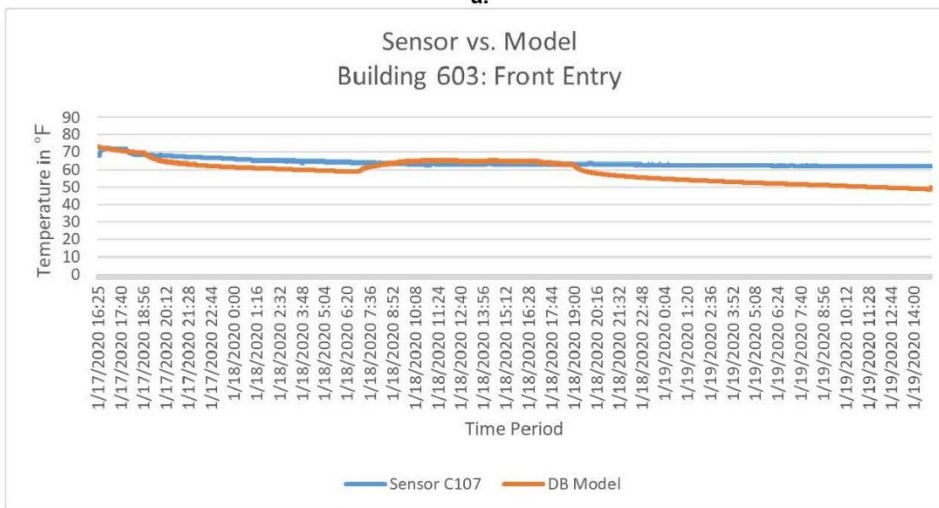

b.

Figure B-11. Bldg. 603 Mezzanine and Front Entry air temperature details.

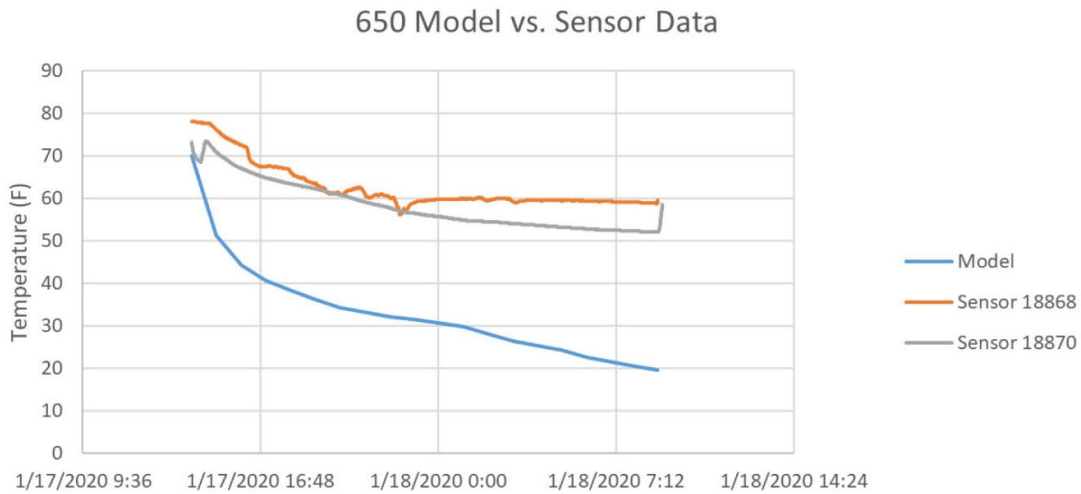

Figure B-12. Bldg. 650 model vs. sensor data.

While the model starts off at a similar temperature as the recorded data, the temperature drops off much more quickly than the temperature measured by either of the sensors. When investigating individual blocks within the building model, several areas experience a sharp temperature drop off. The only area of the building that did not experience this sharp drop was the basement block, which likely had extra capacitance from the ground connection, which prevented the sharp drop. The drop may indicate a need for modifications to the simulated building construction.

Overall, the building model results compared well to the sensor data collected from the TDT. Given that the models have reliable agreement with sensor data even with all the differences between models and real structures, it is concluded that the models will be a reliable, will make conservative predictions of the real building performance, and can then be used to extend to other building types and scenarios.

B.8 Parametric analysis

Once there is confidence that the models are reliable and can be used to determine the required response time before damage occurs, it is possible to investigate longer term failure performance, estimate the time for the building to return to setpoint after a failure, etc. Also, environmental conditions can be adjusted from a TMY3 weather file to a steady state temperature to determine the response times, i.e., a constant -20 °F, -40 °F (-28.9 °C, 40.0 °C), etc., which can be used to generate a table of response times for a specific building category type. Also, construction options or standards by building category can be investigated for envelope specifications, i.e., wall and roof insulation levels, type of windows, air tightness, etc. This section will use a prototypical building model and will make some envelope comparisons such that each supporting graph has green 60 °F (15.6 °C) and blue 40 °F (4.4 °C) lines. The 60 °F (15.6 °C) limit is the habitability threshold and 40 °F (4.4 °C) is the sustainability threshold. Both are conservative with the sustainability threshold above the temperature were damage can occur in the facility. During an emergency, maintaining optimal comfort conditions may not be feasible. In this case, mission critical areas can be conditioned to different thermal requirement thresholds. These requirements include the ability to perform the required work in a safe and efficient manner, support the processes housed in the building and that temperature will be at 60 °F (15.6 °C). The 40 °F (4.4 °C) is to ensure long-term sustainability of the building or the point if the temperature goes below damage to the structure can begin. Additional information on

thermal energy requirements can be found in Zhivov et al. (2021b), “Requirements for Building Thermal Conditions under Normal and Emergency Operations in Extreme Climates.”

B.9 Analysis process

Building 4070 was modeled to have a heating failure and not an electrical failure, so the lights and equipment schedule in the model were not changed. This was meant to be more of a real failure. Table B-3 summarizes the process for how the time to the habitability and sustainability limits were determined for the -60 °F (-51 °C) case. This selection process will be the basis for all of the charts in all scenarios, but this one will go into the details. In Table B-3, the data for Bldg. 4070 show the hourly temperatures in degrees Fahrenheit for some of the zones on Floors 1 and 2 and the basement. When the temperatures are above 61 °F (16 °C), the cell is shaded green. When the temperature is between 41 °F and 61 °F (5 °C and 16 °C), the shading shows amber. Finally, when the temperature is below 41 °F (5 °C), the shading shows red. The 61 °F (16 °C) limit is the habitability threshold and 41 °F (5 °C) is the sustainability threshold. Both are conservative with the sustainability threshold above the temperature at which damage can occur in the facility.

The Failure Hours column shows a number of hours after the failure has started, so that, on January 11, 9 a.m. is “hour one” into the failure that started at 8 a.m. With this information, a user can quickly scan through the rows of temperature data and see when and where the temperature decay crosses these limits. The room temperatures on floors 1 and 2 were selected to determine the time to exceed habitability threshold since this is where the mission of the facility will be maintained. Even though spaces in the basement reached and exceeded the limit first, this will not harm the equipment in those locations. But for the sustainability threshold, the basement spaces were the areas that were used to set the times. This was determined by how the facility was being operated and the mission is accomplished on Floor 1 and 2 while piping and other critical equipment would be affected when the sustainability threshold is exceeded. Given this process, the MaxTTR tables were developed for a range of temperatures: -60 °F, -40 °F, -20 °F, 0 °F, 20 °F, and 40 °F (-51 °C, -40 °C, -29 °C, -18 °C, -6.6 °C, and 4.4 °C). In the table below, the failure time is underlined and the area where the MaxTTR thresholds are pertinent are highlighted.

Table B-3 lists the -60 °F (-51 °C) simulation results by room and floor.

Table B-3. Simulation results by room and floor (-60 °F [-51 °C]).

Date/Time	Failure Hours	ODB	2	2	2	2	2	2	1	1	1	1	1	1	B	B	B	B	B	B
01/11 01:00:00	0	-60	72	72	72	72	72	72	72	72	72	72	72	72	72	72	72	72	72	72
01/11 02:00:00	0	-60	72	72	72	72	72	72	72	72	72	72	72	72	72	72	72	72	72	72
01/11 03:00:00	0	-60	72	72	72	72	72	72	72	72	72	72	72	72	72	72	72	72	72	72
01/11 04:00:00	0	-60	72	72	72	72	72	72	72	72	72	72	72	72	72	72	72	72	72	72
01/11 05:00:00	0	-60	72	72	72	72	72	72	72	72	72	72	72	72	72	72	72	72	72	72
01/11 06:00:00	0	-60	72	72	72	72	72	72	72	72	72	72	72	72	72	72	72	72	72	72
01/11 07:00:00	0	-60	72	72	72	72	72	72	72	72	72	72	72	72	72	72	72	72	72	72
01/11 08:00:00	0	-60	72	72	72	72	72	72	72	72	72	72	72	72	72	72	72	72	72	72
01/11 09:00:00	1	-60	64	66	65	65	64	64	67	64	64	65	66	62	61	64	62	62	64	61
01/11 10:00:00	2	-60	62	65	63	62	63	62	65	61	61	63	64	59	56	61	58	57	62	56
01/11 11:00:00	3	-60	61	64	63	61	62	61	65	61	60	62	64	58	55	60	57	56	62	55

Date/Time	Failure Hours	ODB	2	2	2	2	2	2	1	1	1	1	1	1	B	B	B	B	B	B
01/11 12:00:00	4	-60	61	64	62	61	62	61	64	60	60	62	63	58	55	59	56	55	61	55
01/11 13:00:00	5	-60	61	64	62	60	62	60	64	60	59	61	63	57	54	59	56	55	60	54
01/11 14:00:00	6	-60	60	63	61	60	61	60	64	59	59	61	63	57	53	58	55	54	60	53
01/11 15:00:00	7	-60	60	63	61	60	61	59	63	59	58	61	62	56	53	58	54	54	59	53
01/11 16:00:00	8	-60	59	63	61	59	61	59	63	59	58	60	62	56	52	57	54	53	59	52
01/11 17:00:00	9	-60	59	62	60	59	59	58	63	58	58	60	62	55	52	57	53	53	58	52
01/11 18:00:00	10	-60	58	62	60	59	58	58	62	58	57	60	61	55	51	56	53	52	58	52
01/11 19:00:00	11	-60	58	62	59	58	58	57	62	58	57	59	61	55	51	56	51	50	57	51
01/11 20:00:00	12	-60	58	60	59	58	57	57	60	57	56	58	59	55	50	54	50	49	56	49
01/11 21:00:00	13	-60	57	59	59	58	57	57	60	57	56	57	59	54	50	53	50	49	55	48
01/11 22:00:00	14	-60	57	59	59	56	56	56	59	56	56	56	58	54	49	53	49	48	54	48
01/11 23:00:00	15	-60	56	58	58	55	56	56	59	56	55	56	58	53	49	52	49	47	54	47
01/11 24:00:00	16	-60	56	58	58	54	55	55	58	55	55	55	57	53	48	51	48	47	53	46
01/12 01:00:00	17	-60	55	58	57	53	55	55	58	55	54	55	57	53	48	51	47	46	52	46
01/12 02:00:00	18	-60	55	57	57	53	55	54	58	54	54	55	56	52	47	50	47	46	52	45
01/12 03:00:00	19	-60	54	57	56	52	54	54	57	54	53	54	56	52	47	50	46	45	51	45
01/12 04:00:00	20	-60	54	56	56	52	54	54	57	54	53	54	55	51	46	49	46	45	51	44
01/12 05:00:00	21	-60	53	56	55	51	53	53	56	53	53	53	55	51	46	49	45	44	50	44
01/12 06:00:00	22	-60	53	55	55	53	53	53	56	53	52	53	55	51	45	48	45	44	50	43
01/12 07:00:00	23	-60	52	55	55	53	52	52	55	52	52	52	54	50	45	48	44	43	49	43
01/12 08:00:00	24	-60	52	55	54	53	52	52	55	52	51	52	54	50	44	47	44	43	48	42
01/12 09:00:00	25	-60	52	54	54	52	52	51	55	52	51	52	53	49	44	47	44	42	48	42
01/12 10:00:00	26	-60	51	54	54	52	53	51	54	51	51	51	53	49	44	46	44	42	47	41
01/12 11:00:00	27	-60	51	53	53	52	53	51	54	51	50	51	53	48	43	46	44	41	47	41
01/12 12:00:00	28	-60	51	53	53	52	53	50	53	51	50	50	52	48	43	45	44	41	46	40
01/12 13:00:00	29	-60	50	53	53	51	52	50	53	50	50	50	52	48	42	45	43	40	46	40
01/12 14:00:00	30	-60	50	52	52	51	52	50	53	50	49	49	51	47	42	45	43	40	46	39
01/12 15:00:00	31	-60	49	52	52	51	52	50	52	49	49	49	51	47	42	44	43	40	45	39
01/12 16:00:00	32	-60	49	52	52	51	52	49	52	49	48	49	51	46	41	44	42	39	45	39
01/12 17:00:00	33	-60	49	51	51	50	51	49	51	48	48	48	50	46	41	43	42	39	44	38
01/12 18:00:00	34	-60	48	51	51	50	50	49	51	48	48	48	50	46	40	43	42	38	44	38
01/12 19:00:00	35	-60	48	50	51	50	49	48	51	48	47	47	50	45	40	42	40	38	43	37
01/12 20:00:00	36	-60	48	50	50	49	49	48	50	47	47	47	49	45	40	42	40	38	43	37
01/12 21:00:00	37	-60	47	50	50	49	48	47	50	47	46	47	49	45	39	42	39	37	42	36
01/12 22:00:00	38	-60	47	49	50	47	48	47	49	47	46	46	48	44	39	41	39	37	42	36
01/12 23:00:00	39	-60	46	49	49	46	47	47	49	46	46	46	48	44	38	41	38	36	42	36
01/12 24:00:00	40	-60	46	49	49	45	47	46	49	46	45	46	48	43	38	40	38	36	41	35
01/13 01:00:00	41	-60	46	48	48	45	46	46	48	45	45	45	47	43	38	40	37	36	41	35
01/13 02:00:00	42	-60	45	48	48	44	46	45	48	45	45	45	47	43	37	40	37	35	40	35
01/13 03:00:00	43	-60	45	47	47	44	46	45	47	45	44	44	46	42	37	39	36	35	40	34
01/13 04:00:00	44	-60	44	47	47	43	45	45	47	44	44	44	46	42	37	39	36	35	40	34
01/13 05:00:00	45	-60	44	47	47	43	45	44	47	44	44	44	46	42	36	38	36	34	39	34
01/13 06:00:00	46	-60	44	46	46	44	44	44	46	43	43	43	45	41	36	38	35	34	39	33
01/13 07:00:00	47	-60	43	46	46	45	44	43	46	43	43	43	45	41	36	38	35	33	38	33
01/13 08:00:00	48	-60	43	46	46	44	44	43	45	43	42	43	45	40	35	37	35	33	38	32
01/13 09:00:00	49	-60	43	45	45	44	43	43	45	42	42	42	44	40	35	37	34	33	38	32
01/13 10:00:00	50	-60	42	45	45	44	44	42	45	42	42	42	44	40	34	37	34	32	37	32
01/13 11:00:00	51	-60	42	44	45	44	44	42	44	42	41	41	44	39	34	36	34	32	37	31

Date/Time	Failure Hours	ODB	2	2	2	2	2	2	1	1	1	1	1	1	B	B	B	B	B	B
01/13 12:00:00	52	-60	41	44	44	44	44	41	44	41	41	41	43	39	34	36	33	32	37	31
01/13 13:00:00	53	-60	41	44	44	43	44	41	44	41	41	41	43	39	34	36	33	31	36	31
01/13 14:00:00	54	-60	41	43	44	43	44	41	43	40	40	40	42	38	33	35	32	31	36	30
01/13 15:00:00	55	-60	40	43	43	43	43	40	43	40	40	40	42	38	33	35	32	31	36	30
01/13 16:00:00	56	-60	40	43	43	43	43	40	42	40	40	40	42	37	33	35	32	30	35	30
01/13 17:00:00	57	-60	40	42	43	42	43	40	42	39	39	39	41	37	32	34	31	30	35	30
01/13 18:00:00	58	-60	39	42	42	42	41	39	42	39	39	39	41	37	32	34	31	30	35	29
01/13 19:00:00	59	-60	39	42	42	42	41	39	41	39	39	39	41	36	32	34	31	29	34	29
01/13 20:00:00	60	-60	38	41	42	41	40	39	41	38	38	38	40	36	31	33	31	29	34	29
01/13 21:00:00	61	-60	38	41	41	41	40	38	41	38	38	38	40	36	31	33	30	29	33	28
01/13 22:00:00	62	-60	38	41	41	39	39	38	40	38	38	38	40	35	31	33	30	29	33	28
01/13 23:00:00	63	-60	37	40	41	38	39	38	40	37	37	37	39	35	30	32	30	28	33	28
01/13 24:00:00	64	-60	37	40	40	38	39	37	40	37	37	37	39	34	30	32	29	28	33	27
01/14 01:00:00	65	-60	37	40	40	37	38	37	39	36	37	37	39	34	30	32	29	28	32	27
01/14 02:00:00	66	-60	36	39	40	37	38	37	39	36	36	36	38	34	29	31	29	27	32	27
01/14 03:00:00	67	-60	36	39	39	36	37	36	39	36	36	36	38	33	29	31	28	27	32	27

Six scenarios were being investigated using the prototypical Bldg. 4070 and the process described above, but with variations in construction, window, and air leakage changes. Table B-4 lists the building parameters that varied, along with the high mass or CMU and slab floor structures. After this, the building structure was changed to framing elements, which include lesser amounts of building mass than CMU or poured slab buildings. For the time to exceed habitability threshold with these parameters selected, room temperatures were modeled on floors 1 and 2 (where the mission of the facility will be maintained) — even though temperature limits were reached and exceeded in the basement spaces (where equipment would not be harmed). Nevertheless, for the sustainability threshold, the basement spaces were used to set the times as determined by considering how the facility was being operated, by considering the mission being accomplished on floors 1 and 2, and by considering how piping and other critical equipment would be affected when the sustainability threshold was exceeded. The MaxTTR tables were developed in consideration of this process.

Table B-4. Building parameters that are different, and MaxTTR for constant low outdoor temperatures (ODB).

Building Parameters	High Mass Building CMU Walls and Poured Concrete Floors and Roof Deck			Frame Building Frame Wall, Roof, and Floors		
	Typical 1980	Low Efficiency	High Efficiency	Typical 1980	Low Efficiency	High Efficiency
Walls (R-value IP)	20.5	40	50	20.5	40	50
Roof (R-value IP)	31.5	45	60	31.5	45	60
Air Leakage (ACH)	0.4	0.25	0.15	0.4	0.25	0.15
Window (R-Value/U-value)	Double Pane; R= 1.78 / U=0.56	Double Pane; R=3.34 / U=0.3	Triple Pane; R= 5.25/ U=0.19	Double Pane; R= 1.78 / U=0.56	Double Pane; R=3.34 / U=0.3	Triple Pane; R=5.25 / U=0.19
MaxTTR Habitability (60 °F [15.6 °C])	2 hours	9 hours	18 hours	1 hour	3 hours	6 hours

Building Parameters	High Mass Building CMU Walls and Poured Concrete Floors and Roof Deck			Frame Building Frame Wall, Roof, and Floors		
	Typical 1980	Low Efficiency	High Efficiency	Typical 1980	Low Efficiency	High Efficiency
MaxTTR Sustainability (40 °F [4.4 °C])	32 hours	67 hours	94 hours	14 hours	24 hours	34 hours

Table B-4 lists the building envelope parameters, as mentioned above, and the tabular results for all of the constant low temperature modeled analysis shown for both the habitability and sustainability thresholds in hours from start of failure. The constant low temperature is a special weather case used as a conservative way to determine the MaxTTR. Figure B-13 shows the building performance and comparisons for select outdoor temperatures as examples and not all of the temperature cases addressed in Table B-3.

Figure B-13a shows a **mass building with lower efficiency envelope** parameters and a normal TMY3 file and files with constant low temperatures, i.e., -20 °F, -40 °F (-28.9 °C, 40.0 °C). Also, for comparison is the 1st floor radiant temperature with TMY3 weather is plotted to see the impact and time delay of the radiant temperature compared to the air temperature. Figure B-14 shows that the air temperature in the mass building lags both in temperature decay and especially during temperature recovery back to setpoint. To keep the figure from being too cluttered, only one radiant temperature is plotted but the general behavior for the other two cases would be similar.

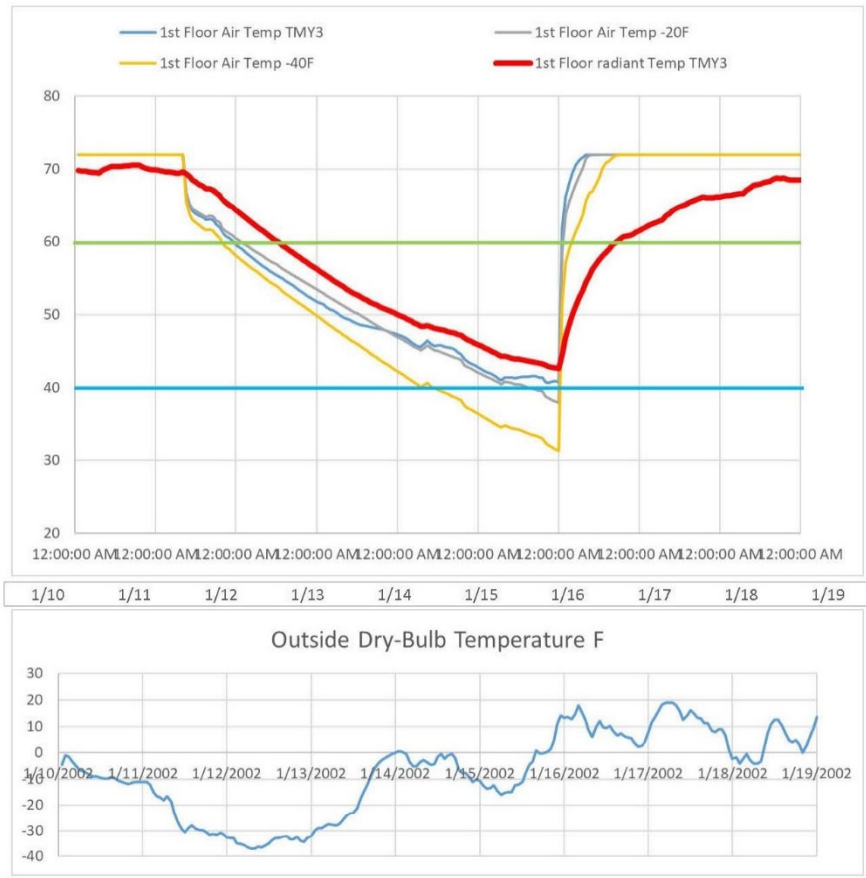

a.

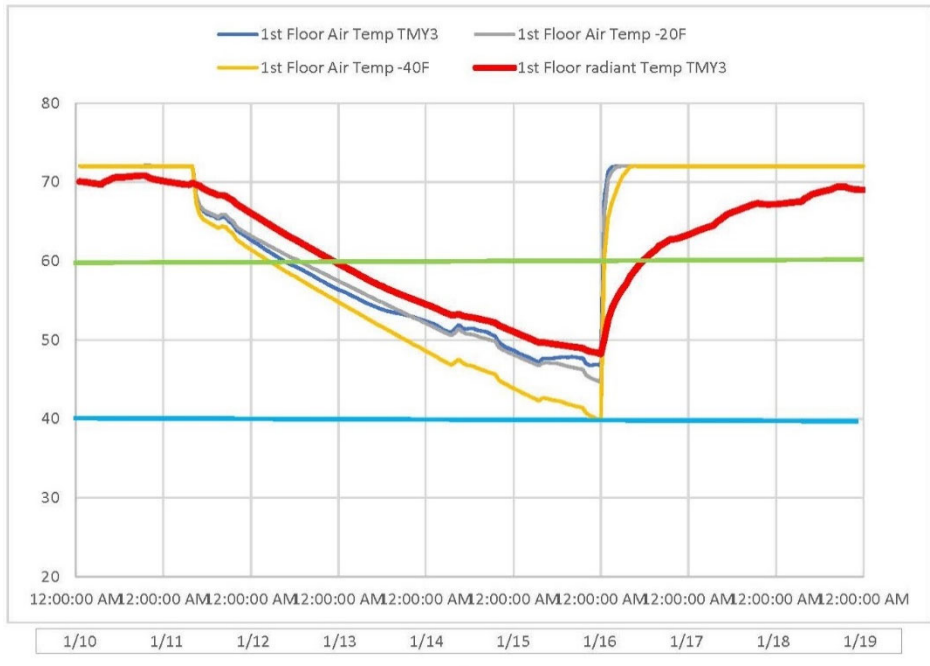

b.

Figure B-13. First-floor low-efficiency (a) and high efficiency (b) mass building heating failure results with TMY3, -20 °F, and -40 °F weather, from January 10 to 19.

Figure B-13 plots outdoor air temperature for the TMY3 Fairbanks weather data for reference. The graph in Figure B-13 shows how the air temperature quickly drops below the radiant temperature that lags the air temperature as the capacitance of the building is being discharged. Then, after the 5 days when heating is restored, the air temperature recovers in hours while the building capacitance takes days to return to its pre-failure norm. Also plotted on each graph in Figure B-13 is a 60 °F (15.6 °C) and 40 °F (4.4 °C) line. Note that only the TMY3 weather data did not pass through the 40 °F (4.4 °C) threshold, but the constant low temperatures did but not until several days had passed.

Figure B-14b reflects a **mass building with high-efficiency envelope** parameters and is shown with a normal TMY3 file and several files with constant low temperatures, i.e., -20 °F, -40 °F (-28.9 °C, 40.0 °C). Also, this is compared with the 1st Floor Radiant Temperature with TMY3 weather to see the impact and time delay of the radiant temperature compared to the air temperature. The graph in Figure B-14 shows how the air temperature in the mass building lags both in temperature decay and especially during the temperature recovery back to setpoint.

After 5 days when heating is restored, the air temperature for all three cases does not pass the 40 °F (4.4 °C) threshold. This building with high mass and high-efficiency building envelope could sustain a 5-day heat outage even with extreme constant -40 °F (-40.0 °C) outdoor temperatures.

Figure B-14a represents a **frame building with lower efficiency** envelope parameters and is shown with a normal TMY3 file and several files with constant low temperatures, i.e., -20 °F, -40 °F (-28.9 °C, 40.0 °C). It is also useful to compare the 1st Floor Radiant Temperature with TMY3 weather to see the impact and time delay of the radiant temperature compared to the air temperature. Figure B-15 shows how a mass building delays the air temperature change, both in temperature decay and (especially) during the recovery back to setpoint.

This low capacitance frame structure would reach the 40 °F (4.4 °C) threshold after about a day in all cases. This building would need to have the heat restored in the first day to prevent damage.

Figure B-14b represents a **frame building with high-efficiency** envelope parameters and is shown with a normal TMY3 file and several files with constant low temperatures, i.e., -20 °F, -40 °F (-28.9 °C, 40.0 °C). It is also useful to compare the 1st Floor Radiant Temperature with TMY3 weather to see the impact and time delay of the radiant temperature compared to the air temperature. Figure B-15 represents a mass building, which delays the air temperature change, both in temperature decay and (especially) during the recovery back to setpoint.

This low capacitance frame structure would reach the 40 °F (4.4 °C) threshold after about 1½ days in all cases. The higher efficiency envelope parameters allow for approximately a ½ day additional time for response before damage starts occurring.

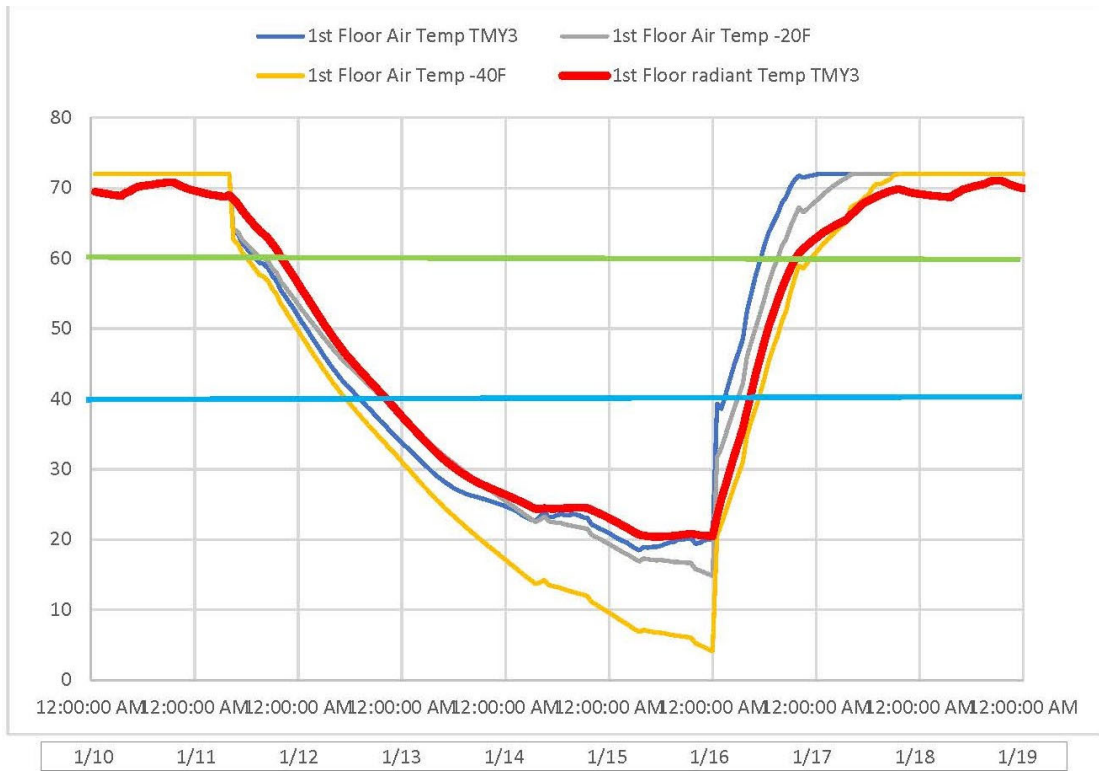

a.

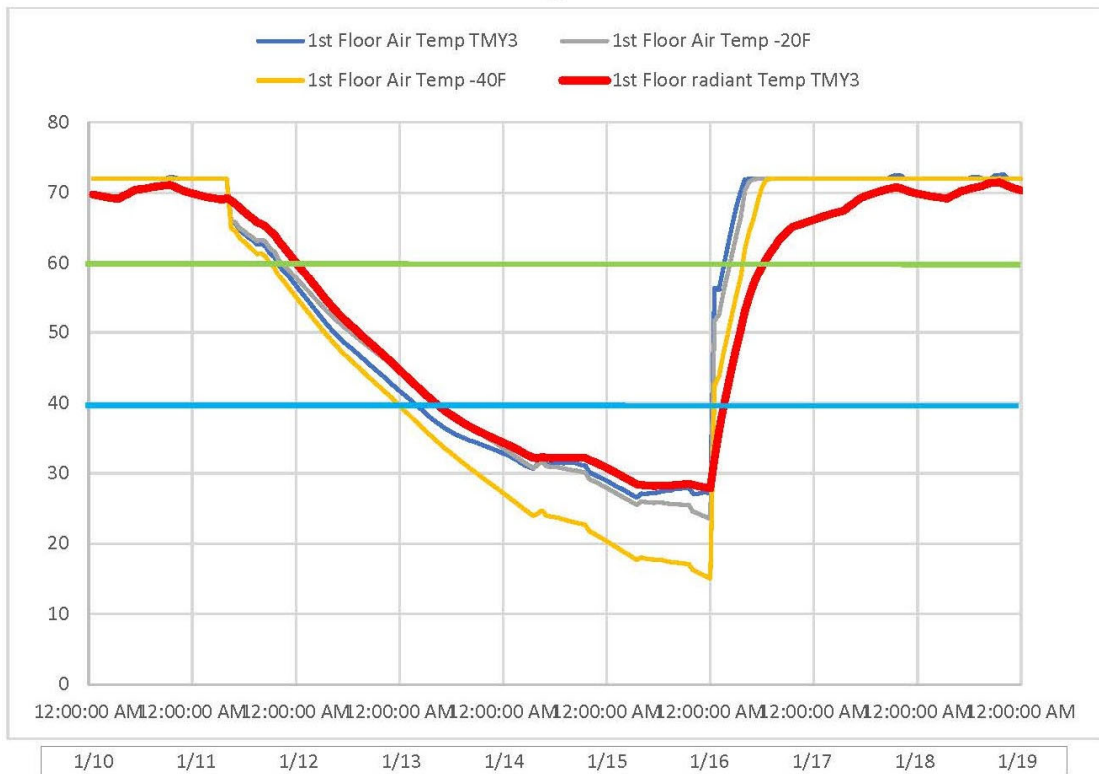

b.

Figure B-14. First-Floor low-efficiency (a) and High Efficiency (b) Frame Building Heating Failure Results with TMY3, -20 °F, and -40 °F Weather.

Figure B-15 shows a cross comparison of the **mass building** with a constant -40 °F (-40.0 °C) weather showing the air temperature from the high-efficiency, lower efficiency, and typical 1980 envelope constructions. (In this case it is lower efficiency of current standards when these buildings were built or retrofitted). Figure B-15 shows that, at the end of the 5th day of failure, the efficient building envelope parameters of the mass structure are about 8 °F (4.5 °C) higher, which keeps the building above the threshold for about 1½ days longer.

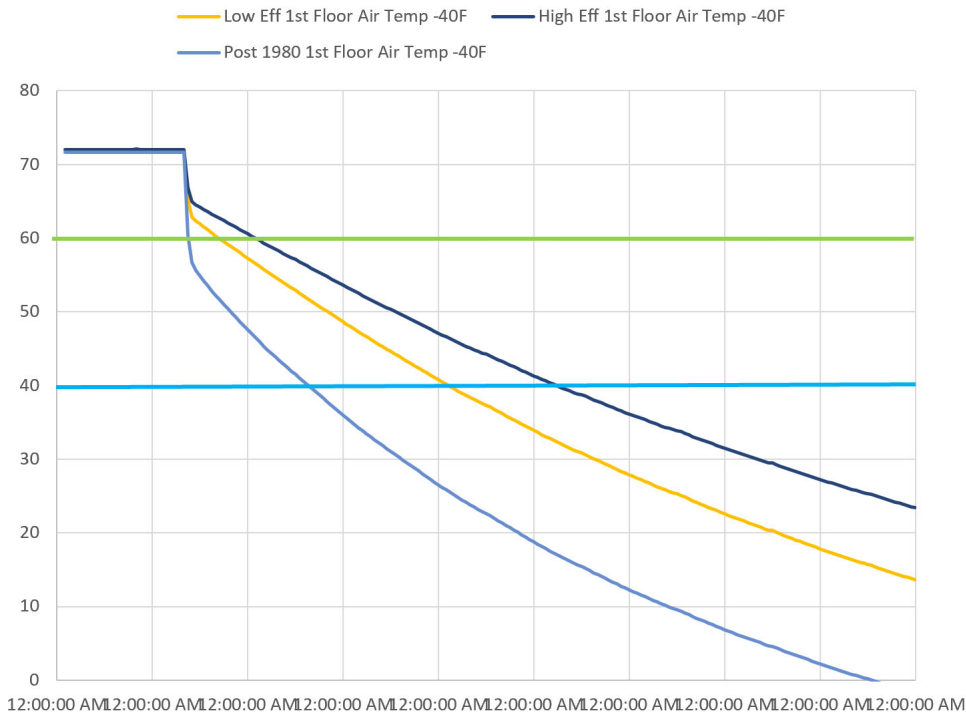
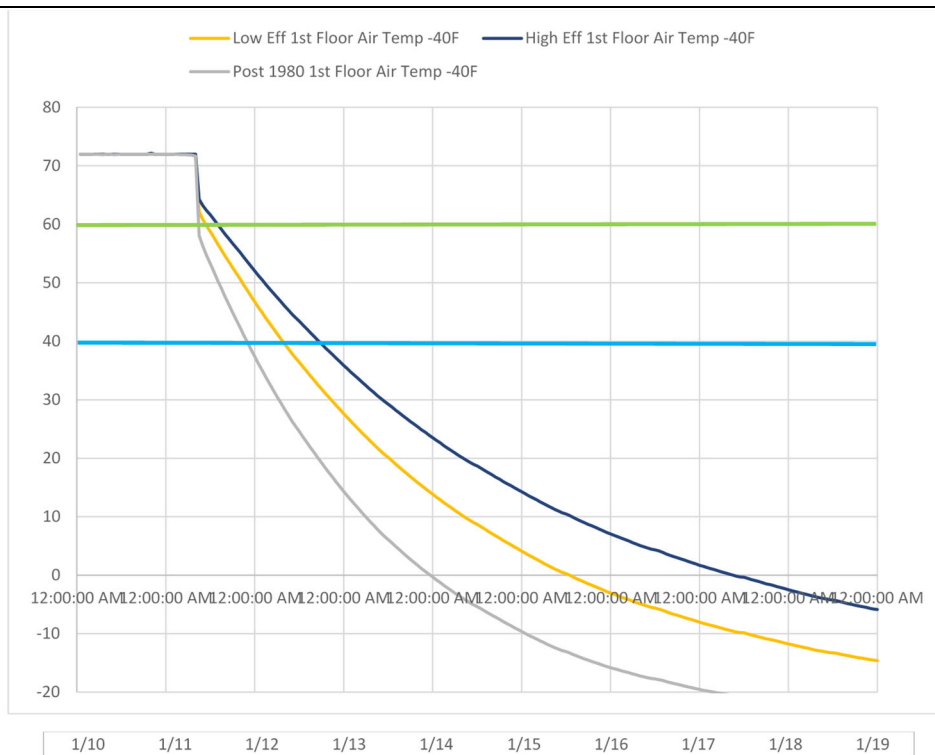
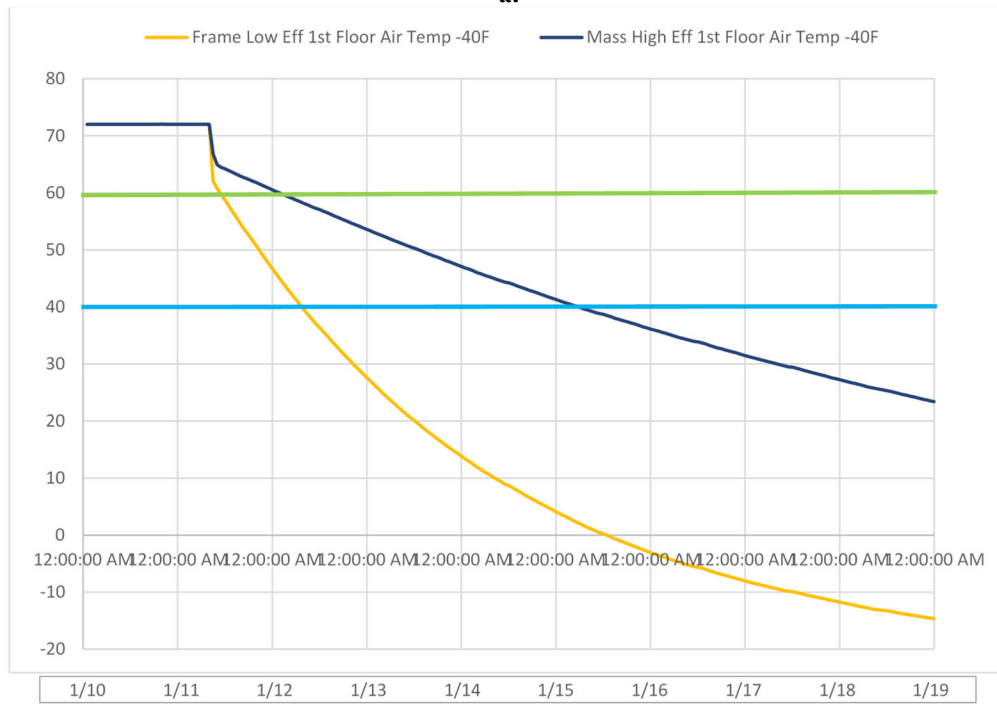

Figure B-15. Mass building comparison of high-efficiency, low-efficiency, and typical 1980 parameters for building heating failure results with -40 °F (-40.0 °C) Weather

Figure B-16a shows a cross comparison of the **frame building** experiencing -40 °F (-40.0 °C) weather and displays the air temperature from the high-efficiency, lower efficiency, and typical 1980 envelopes. The high-efficiency frame building envelope parameters provide an extra ½ day before the 40 °F (4.4 °C) threshold is crossed relative to the lower efficiency parameters. In a 5-day heating failure, both buildings would incur freeze damage. The typical 1980 building is included for reference to show how older building parameters compare.



a.



b.

Figure B-16. Frame building (a) and mass building (b) comparison of high efficiency vs. low-efficiency and (typical 1980 in [a]) building heating failure results at -40 °F (-40.0 °C) weather.

Figure B-16b shows a cross comparison of the frame building low efficiency and the mass building with high-efficiency parameters with $-40\text{ }^{\circ}\text{F}$ ($-40.0\text{ }^{\circ}\text{C}$) weather. This directly shows the best performer and the worst performer to see how efficient and capacitive buildings can perform in extreme weather conditions. Figure B-16b shows that the difference between 1 day and ~ 5 days of heating failure can affect the survivability of an emergency heating failure in an extreme arctic environment for each type of building. This information indicates that it would be appropriate to house critical missions in efficient and capacitive buildings.

B.10 Conclusions

This appendix is the result of a one of the first-of-its-kind study undertaken to attempt to address thermal decay in cold environments.

A team of U.S. Army Engineer Research and Development Center (ERDC) researchers in collaboration with researchers from the University of Alaska envisioned, developed, and conducted a TDT at Fort Wainwright, AK and Fort Greely, AK. These tests were performed while outside air temperatures ranged between $-20\text{ }^{\circ}\text{F}$ and $-40\text{ }^{\circ}\text{F}$ ($-28.9\text{ }^{\circ}\text{C}$ and $-40\text{ }^{\circ}\text{C}$), which allowed the collection of building-specific data on temperature change in different building areas and different surfaces of tested buildings to identify critical areas with significant temperature degradation compared to other building areas.

Results of these tests indicate that air temperature in mechanical rooms located in the basement, in a semi-basement, or on the first floor having openings for make-up air, fenestration, or a large open stairway column located nearby deteriorate faster than in other parts of the building; therefore, mechanical rooms can be used as representative locations to identify the length of time when a building will reach the habitability and sustainability thresholds. Typically, a building's middle floors take the longest time to achieve the habitability threshold; therefore, these locations are recommended for hosting mission critical operations. Furthermore, the modeling of these buildings using the weather data corresponding to the test dates allowed for the calibration of building models for use in parametric studies of representative buildings.

Building indoor air temperature degradation was studied for high mass buildings (CMU and poured concrete slabs) and light-frame buildings with thermal characteristics ranging from pre-1980 code construction, current minimum energy efficiency requirements (lower efficiency), and state-of-the-art energy efficient building characteristics (high efficiency) for buildings constructed in U.S. Department of Energy (DOE) Climate Zone 8. The previous section clearly shows that high mass buildings make a large contribution to the thermal resilience of buildings, as do the obvious parameters of building air tightness and controlled air flow across the building envelope. Figure B-17 shows the graphed results of a simulation run with a constant $-40\text{ }^{\circ}\text{F}$ ($-40.0\text{ }^{\circ}\text{C}$) outdoor temperature for the mass building with lower efficiency envelope parameters. Under normal operating conditions, the red line is the radiant temperature, which gives an indication of the surface temperatures in the first-floor zones. Pre-failure for the mass building the radiant and air temperatures are very similar to the radiant temperature a couple of degrees below the air temperature. This difference is larger with the $-40\text{ }^{\circ}\text{F}$ ($4.4\text{ }^{\circ}\text{C}$) ODB compared to an outdoor temperature of $0\text{ }^{\circ}\text{F}$ ($-17.8\text{ }^{\circ}\text{C}$). Therefore, the building capacitance would be considered charged.

During the failure, the room air temperature crosses and falls lower than the room mean radiant temperature; the room air temperature leads the decrease while the radiant temperature lags.

With a constant theoretical -40 °F (-40.0 °C) outside air temperature, there is a smooth temperature decay slope for both the room air and the room mean radiant temperatures. The room air temperature reaches a minimum temperature of 31.3 °F (-0.4 °C) after 5 days. Then the heating is restored, and the building starts to recover. The heating was restored at midnight and the air temperature reaches room setpoint 12 to 13 hours later for this building. However, note that the lag is now the radiant temperature, which does not reach its pre-failure state until after 3 days of heating from heat restoration and ~ 2 ½ days longer that the room air temperature. In the heating graph in Figure B-17, notice the amount of heating that takes place for several days after the air temperature has reached setpoint. This is the amount of time it takes to recharge the building capacitance and bring it back to the pre-failure building conditions

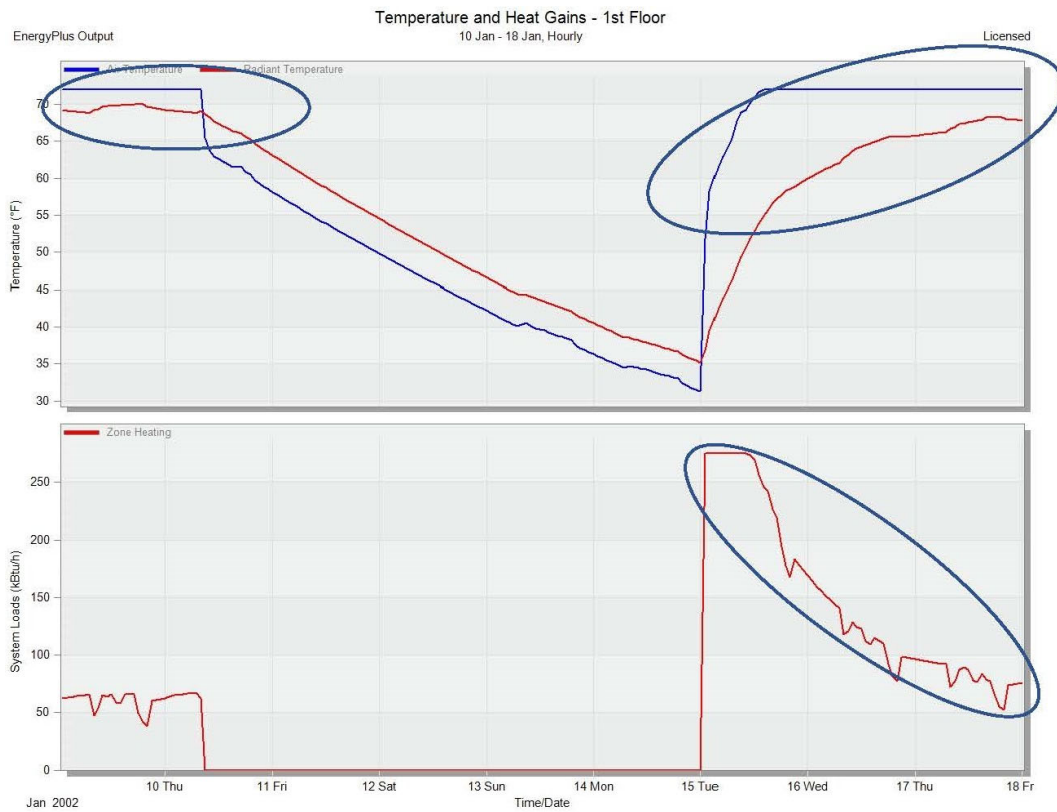

Figure B-17. Building 4070 heating failure results in 40 °F weather.

The 40 °F (4.4 °C) limit is a good metric to respond before it is reached when determining a time to repair for heating restoration. This gives time for repair while providing a safety factor before damage can occur in the structure or mechanical and water systems.

Another area of the Temperature Decay Chart above is slope of the decay. The slope on the air temperature decay is an indicator of the efficiency of the building envelope and the operation of the building systems and occupants as shown in the modeled scenarios. Any envelope efficiency changes, i.e., reduction in insulation levels or decrease in building air tightness, will decrease the thermal resiliency of the building. This will show how quickly operations will have to respond to certain buildings either to prevent damage or to maintain mission effectiveness.

The last part of the graph shown in Figure B-17 indicates how long recovery takes once the heating has been restored. In mass scenario shown above, it takes about ½ day to recover to the normal operating air temperature in the building, with more than 3 days needed to recharge the

thermal capacitance. The rate of temperature decay, and minimum temperature and the length of recovery time are all significant aspects of the building's thermal resiliency with the more efficient and capacitive structure being more thermally resilient.

This Guide is the first attempt to address requirements to thermal energy systems resilience, which is especially important in extreme climates. It helps to identify maximum allowable time available to correct any problems with heat supply to mission critical facilities for different facility archetypes (building mass, and insulation characteristics) and air leakage rates before the indoor air temperature reaches habitability or sustainability thresholds. This effort went beyond the traditional approach to establish requirements to building envelope characteristics based on economic and environmental considerations to introduce the consideration of thermal energy system resilience as another parameter in the optimization process.

Arctic climates provide unique challenges to designers of HVAC, plumbing, and thermal energy systems. The importance of considering facility operation in the context of outside air temperatures, system reliability, and building resiliency cannot be understated. This Guide describes best practice examples of robust and reliable systems that emphasize redundancy, durability, and functionality.

The target audience for this Guide are technical experts involved in building and energy systems design, renovation, operation and maintenance; architectural and engineering professionals; and energy service companies. The content of this Guide may also be of interest to building owners, executive decision makers, and energy managers of public, government, and military organizations.

The Guide was developed with partial support by the DoD Environmental Security Technology Certification Program, the Office of the Deputy Assistant Secretary of the Army, U.S. Army Program 633734T1500, Military Engineering Technology Demonstration, and the International Energy Agency Energy in Buildings and Communities Program Annex 73.



The following organizations significantly contributed to the content of this Guide:



Print edition published by



ISBN 978-1-947192-83-6 (paperback)

ISBN 978-1-947192-84-3 (PDF)



Product Code: 90469

04/21